

**VEHICLE STANDARD (AUSTRALIAN DESIGN RULE 79/01 — EMISSION CONTROL
FOR LIGHT VEHICLES) 2005**

APPENDIX A

United Nations Economic Commission for Europe Regulation No. 83, UNIFORM PROVISIONS CONCERNING THE APPROVAL OF VEHICLES WITH REGARD TO THE EMISSION OF POLLUTANTS ACCORDING TO ENGINE FUEL REQUIREMENTS, Revision 3, incorporating the 05 series of amendments and all amendments up to and including Supplement 1 to the 05 series of amendments

Regulation No. 83

**UNIFORM PROVISIONS CONCERNING THE APPROVAL OF VEHICLES WITH REGARD TO THE
EMISSION OF POLLUTANTS ACCORDING TO ENGINE FUEL REQUIREMENTS**

CONTENTS

1. SCOPE	7
2. DEFINITIONS	8
3. APPLICATION FOR APPROVAL	12
4. APPROVAL.....	13
5. SPECIFICATIONS AND TESTS.....	15
6. MODIFICATIONS OF THE VEHICLE TYPE.....	29
7. EXTENSION OF APPROVAL.....	29
8. CONFORMITY OF PRODUCTION (COP).....	33
9. PENALTIES FOR NON-CONFORMITY OF PRODUCTION.....	43
11. TRANSITIONAL PROVISIONS	44
12. NAMES AND ADDRESSES OF TECHNICAL SERVICES RESPONSIBLE FOR CONDUCTING APPROVAL TESTS, AND OF ADMINISTRATIVE DEPARTMENTS	48
APPENDIX 1.....	49
PROCEDURE FOR VERIFYING THE CONFORMITY OF PRODUCTION REQUIREMENTS IF THE PRODUCTION STANDARD DEVIATION GIVEN BY THE MANUFACTURER IS SATISFACTORY	49
APPENDIX 2.....	52
PROCEDURE FOR VERIFYING THE CONFORMITY OF PRODUCTION REQUIREMENTS IF THE PRODUCTION STANDARD DEVIATION GIVEN BY THE MANUFACTURER IS EITHER NOT SATISFACTORY OR NOT AVAILABLE	52
APPENDIX 3.....	55
IN-SERVICE CONFORMITY CHECK.....	55
1. INTRODUCTION	55
2. SELECTION CRITERIA	55
3. DIAGNOSIS AND MAINTENANCE	56
4. IN-SERVICE TESTING	57
5. EVALUATION OF RESULTS	57
6. PLAN OF REMEDIAL MEASURES	58
APPENDIX 4.....	60
STATISTICAL PROCEDURE FOR IN-SERVICE CONFORMITY TESTING	60

ANNEX 1.....	67
ENGINE AND VEHICLE CHARACTERISTICS.....	67
ANNEX 2.....	83
COMMUNICATION.....	83
ANNEX 2 – APPENDIX 1	88
OBD – RELATED INFORMATION	88
ANNEX 3.....	89
ARRANGEMENTS OF THE APPROVAL MARK.....	89
ANNEX 4.....	92
TYPE I TEST.....	92
(Verifying exhaust emissions after a cold start).....	92
1. <i>INTRODUCTION</i>	92
2. <i>OPERATING CYCLE ON THE CHASSIS DYNAMOMETER</i>	92
3. <i>VEHICLE AND FUEL</i>	94
4. <i>TEST EQUIPMENT</i>	95
5. <i>PREPARING THE TEST</i>	103
6. <i>PROCEDURE FOR BENCH TESTS</i>	105
7. <i>PROCEDURE FOR SAMPLING AND ANALYSIS</i>	107
8. <i>DETERMINATION OF THE QUANTITY OF GASEOUS</i>	108
ANNEX 4 - APPENDIX 1	110
BREAKDOWN OF THE OPERATING CYCLE USED FOR THE TYPE I TEST.....	110
1. <i>OPERATING CYCLE</i>	110
2. <i>ELEMENTARY URBAN CYCLE (Part One)</i>	110
3. <i>EXTRA-URBAN CYCLE (Part Two)</i>	116
ANNEX 4 - APPENDIX 2	120
CHASSIS DYNAMOMETER.....	120
1. <i>DEFINITION OF A CHASSIS DYNAMOMETER WITH FIXED LOAD CURVE</i>	120
2. <i>METHOD OF CALIBRATING THE DYNAMOMETER</i>	120
3. <i>SETTING OF THE DYNAMOMETER</i>	124
ANNEX 4 - APPENDIX 3	127
RESISTANCE TO PROGRESS OF A VEHICLE MEASUREMENT METHOD.....	127
1. <i>OBJECT OF THE METHODS</i>	127
2. <i>DEFINITION OF THE ROAD</i>	127
3. <i>ATMOSPHERIC CONDITIONS</i>	127
4. <i>VEHICLE PREPARATION /</i>	127
5. <i>METHODS</i>	129
ANNEX 4 - APPENDIX 4	135
VERIFICATION OF INERTIAS OTHER THAN MECHANICAL.....	135
1. <i>OBJECT</i>	135
2. <i>PRINCIPLE</i>	135
3. <i>SPECIFICATION</i>	136
4. <i>VERIFICATION PROCEDURE</i>	136

ANNEX 4 - APPENDIX 5	137
DEFINITION OF GAS-SAMPLING SYSTEMS	137
1. <i>INTRODUCTION</i>	137
2. <i>CRITERIA RELATING TO THE VARIABLE-DILUTION SYSTEM</i>	137
3. <i>DESCRIPTION OF THE DEVICES</i>	145
ANNEX 4 - APPENDIX 6	154
METHOD OF CALIBRATING THE EQUIPMENT	154
1. <i>ESTABLISHMENT OF THE CALIBRATION CURVE</i>	154
2. <i>CHECKING FOR FID HYDROCARBON RESPONSE</i>	155
3. <i>EFFICIENCY TEST OF THE NO_x CONVERTER</i>	156
4. <i>CALIBRATION OF THE CVS SYSTEM</i>	158
ANNEX 4 - APPENDIX 7	165
TOTAL SYSTEM VERIFICATION	165
ANNEX 4 - APPENDIX 8	166
CALCULATION OF THE MASS EMISSIONS OF POLLUTANTS	166
1. <i>GENERAL PROVISIONS</i>	166
2. <i>SPECIAL PROVISIONS FOR VEHICLES EQUIPPED WITH COMPRESSION-IGNITION ENGINES</i>	172
ANNEX 5	174
TYPE II TEST	174
(Carbon monoxide emission test at idling speed)	174
1. <i>INTRODUCTION</i>	174
2. <i>CONDITIONS OF MEASUREMENT</i>	174
3. <i>SAMPLING OF GASES</i>	175
ANNEX 6	177
TYPE III TEST	177
(Verifying emissions of crankcase gases)	177
1. <i>INTRODUCTION</i>	177
2. <i>GENERAL PROVISIONS</i>	177
3. <i>TEST CONDITIONS</i>	177
4. <i>TEST METHOD</i>	177
5. <i>METHOD OF VERIFICATION OF THE CRANKCASE VENTILATION SYSTEM</i>	178
6. <i>ADDITIONAL TEST METHOD</i>	178
ANNEX 7	181
TYPE IV TEST	181
(Determination of evaporative emissions from vehicles	181
with positive-ignition engines)	181
1. <i>INTRODUCTION</i>	181
2. <i>DESCRIPTION OF TEST</i>	181
3. <i>VEHICLE AND FUEL</i>	181
4. <i>TEST EQUIPMENT FOR EVAPORATIVE TEST</i>	182
5. <i>TEST PROCEDURE</i>	187
6. <i>CALCULATION</i>	193
7. <i>CONFORMITY OF PRODUCTION</i>	195
ANNEX 7 - APPENDIX 1	197
CALIBRATION OF EQUIPMENT FOR EVAPORATIVE EMISSION TESTING	197
1. <i>CALIBRATION FREQUENCY AND METHODS</i>	197
2. <i>CALIBRATION OF THE ENCLOSURE</i>	197
3. <i>CHECKING OF FID HYDROCARBON ANALYZER</i>	201

4. CALIBRATION OF THE HYDROCARBON ANALYZER	201
ANNEX 7 - APPENDIX 2	203
ANNEX 8	204
TYPE VI TEST	204
(Verifying the average exhaust emissions of carbon monoxide and hydrocarbons after a cold start at low ambient temperature)	204
1. INTRODUCTION	204
2. TEST EQUIPMENT	204
3. TEST SEQUENCE AND FUEL	205
4. VEHICLE PRECONDITIONING	208
5. DYNAMOMETER PROCEDURE	210
6. OTHER REQUIREMENTS	212
ANNEX 9	213
TYPE V TEST	213
(Description of the endurance test for verifying the durability of pollution control devices)	213
1. INTRODUCTION	213
2. TEST VEHICLE	213
3. FUEL	213
4. VEHICLE MAINTENANCE AND ADJUSTMENTS	213
5. VEHICLE OPERATION ON TRACK, ROAD OR ON CHASSIS DYNAMOMETER	213
6. MEASURING EMISSIONS OF POLLUTANTS	216
ANNEX 10	218
1. SPECIFICATIONS OF REFERENCE FUELS	218
2. SPECIFICATIONS OF REFERENCE FUELS	220
3. SPECIFICATIONS OF REFERENCE FUEL	222
ANNEX 10A	223
1. SPECIFICATIONS OF GASEOUS REFERENCE FUELS	223
ANNEX 11	226
ON-BOARD DIAGNOSTICS (OBD) FOR MOTOR VEHICLES	226
1. INTRODUCTION	226
2. DEFINITIONS	226
3. REQUIREMENTS AND TESTS	229
4. REQUIREMENTS RELATING TO THE TYPE-APPROVAL	235
5. ACCESS TO OBD INFORMATION	237
ANNEX 11 - APPENDIX 1	239
FUNCTIONAL ASPECTS OF ON-BOARD DIAGNOSTIC (OBD) SYSTEMS	239
1. INTRODUCTION	239
2. DESCRIPTION OF TEST	239
3. TEST VEHICLE AND FUEL	240
4. TEST TEMPERATURE AND PRESSURE	240
5. TEST EQUIPMENT	240
6. OBD TEST PROCEDURE	240
ANNEX 11 - APPENDIX 2	247
ESSENTIAL CHARACTERISTICS OF THE VEHICLE FAMILY	247
1. PARAMETERS DEFINING THE OBD FAMILY	247

ANNEX 12.....	248
GRANTING OF AN ECE TYPE APPROVAL FOR A VEHICLE FUELLED	248
1. INTRODUCTION	248
2. DEFINITIONS	248
3. GRANTING OF A TYPE APPROVAL	249
4. GENERAL CONDITIONS	250
ANNEX 13.....	251
EMISSIONS TEST PROCEDURE FOR A VEHICLE EQUIPPED WITH A PERIODICALLY REGENERATING SYSTEM.....	251
1. INTRODUCTION	251
2. SCOPE AND EXTENSION OF THE TYPE APPROVAL	251
3. TEST PROCEDURE	252
ANNEX 14.....	255
EMISSIONS TEST PROCEDURE FOR HYBRID ELECTRIC VEHICLES (HEV)	255
1. INTRODUCTION	255
2. CATEGORIES OF HYBRID ELECTRIC VEHICLES	255
3. TYPE I TEST METHODS	255
4. TYPE II TEST METHODS	264
6. TYPE IV TEST METHODS	265
7. TYPE V TEST METHODS	266
8. TYPE VI TEST METHODS	267
9. ON BOARD DIAGNOSTICS (OBD) TEST METHODS	267
ANNEX 14 APPENDIX 1	268
ELECTRICAL ENERGY/POWER STORAGE DEVICE STATE OF CHARGE (SOC) PROFILE FOR OVC HEV TYPE I TEST	268

* * *

1. SCOPE

1.1. This Regulation applies to:

1.1.1. Exhaust emissions at normal and low ambient temperature, evaporative emissions, emissions of crankcase gases, the durability of pollution control exhaust devices and on-board diagnostic (OBD) systems of motor vehicles equipped with positive-ignition (P.I.) engines which have at least 4 wheels.

1.1.2. Exhaust emissions, the durability of anti-pollution devices and on-board diagnostic (OBD) systems of vehicles of categories M₁ and N₁ equipped with compression-ignition (C.I.) engines which have at least 4 wheels and a maximum mass not exceeding 3,500 kg.

1.1.3. Exhaust emissions at normal and low ambient temperature, evaporative emissions, emissions of crankcase gases, the durability of pollution control exhaust devices and on-board diagnostic (OBD) systems of hybrid electric vehicles (HEV) equipped with positive-ignition (P.I.) engines and having at least four wheels.

1.1.4. Exhaust emissions, the durability of anti-pollution devices and on-board diagnostic (OBD) systems of hybrid electric vehicles (HEV) of categories M₁ and N₁ equipped with compression-ignition (C.I.) engines, having at least four wheels and a maximum mass not exceeding 3,500 kg.

1.1.5. It does not apply to:

- vehicles with a maximum mass of less than 400 kg and to vehicles having a maximum design speed of less than 50 km/h;
- vehicles whose unladen mass is not more than 400 kg if they are intended for carrying passengers or 550 kg if they are intended for carrying goods and whose maximum engine power does not exceed 15 kW.

1.1.6. At the request of the manufacturer, type approval pursuant to this Regulation may be extended from M₁ or N₁ vehicles equipped with compression-ignition engines which have already been typed approved to M₂ and N₂ vehicles having a reference mass not exceeding 2,840 kg and meeting the conditions of paragraph 7. (extension of approval).

1.1.7. Vehicles of category N1 equipped with compression-ignition engines or equipped with positive-ignition engines fuelled with NG or LPG are not subject to this

Regulation provided they have been type-approved pursuant to Regulation 49 as amended by the last series of amendments.

- 1.2. This Regulation does not apply to vehicles equipped with positive-ignition engines fuelled with NG or LPG used for driving motor vehicles of M1 category having a maximum mass exceeding 3,500 kg, M2, M3, N2, or N3 to which Regulation No. 49 is applicable.

2. DEFINITIONS

For the purposes of this Regulation:

- 2.1. "Vehicle type" means a category of power-driven vehicles that do not differ in such essential respects as:

the equivalent inertia determined in relation to the reference mass as prescribed in Annex 4, paragraph 5.1.; and

- 2.1.2. the engine and vehicle characteristics as defined in Annex 1.

- 2.2. "Reference mass" means the "unladen mass" of the vehicle increased by a uniform figure of 100 kg for test according to Annexes 4 and 8.

- 2.2.1. "Unladen mass" means the mass of the vehicle in running order without driver, passengers or load, but with the fuel tank 90 per cent full and the usual set of tools and spare wheel on board, where applicable.

- 2.3. "Maximum mass" means the technically permissible maximum mass declared by the vehicle manufacturer (this mass may be greater than the maximum mass authorised by the national administration).

- 2.4. "Gaseous pollutants" means the exhaust gas emissions of carbon monoxide, oxides of nitrogen, expressed in nitrogen dioxide (NO₂) equivalent and hydrocarbons assuming ratio of:

- C₁H_{1,85} for petrol,
- C₁H_{1,86} for diesel,
- C₁H_{2,525} for LPG
- C₁H₄ for NG.

- 2.5. "Particulate pollutants" means components of the exhaust gas which are removed from the diluted exhaust gas at a maximum temperature of 325 K (52 °C) by means of the filters described in Annex 4.

- 2.6. "Exhaust emissions" means:
- 2.6.1. for positive-ignition (P.I.) engines, emissions of gaseous pollutants;
- 2.6.2. for compression-ignition (C.I.) engines, emissions of gaseous and particulate pollutants.
- 2.7. "Evaporative emissions" means the hydrocarbon vapours lost from the fuel system of a motor vehicle other than those from exhaust emissions.
- 2.7.1. "Tank breathing losses" are hydrocarbon emissions caused by temperature changes in the fuel tank (assuming a ratio of $C_1H_{2.33}$).
- 2.7.2. "Hot soak losses" are hydrocarbon emissions arising from the fuel system of a stationary vehicle after a period of driving (assuming a ratio of $C_1 H_{2.20}$).
- 2.8. "Engine crankcase" means the spaces in or external to an engine which are connected to the oil sump by internal or external ducts through which gases and vapour can escape.
- 2.9. "Cold start device" means a device that temporarily enriches the air/fuel mixture of the engine thus assisting the engine to start.
- 2.10. "Starting aid" means a device which assists engine start up without enrichment of the air/fuel mixture of the engine, e.g. glow plug, injection timing change, etc.
- 2.11. "Engine capacity" means:
- 2.11.1. for reciprocating piston engines, the nominal engine swept volume;
- 2.11.2. for rotary piston engines (Wankel), twice the nominal swept volume of a combustion chamber per piston.
- 2.12. "Pollution control devices" means those components of a vehicle that control and/or limit exhaust and evaporative emissions.
- 2.13. "OBD" means an on-board diagnostic system for emission control, which has the capability of identifying the likely area of malfunction by means of fault codes stored in computer memory.
- 2.14. "In-service test" means the test and evaluation of conformity conducted in accordance with paragraph 8.2.1. of this Regulation.

- 2.15. "Properly maintained and used" means, for the purpose of a test vehicle, that such a vehicle satisfies the criteria for acceptance of a selected vehicle laid down in paragraph 2. of Appendix 3 to this Regulation.
- 2.16. "Defeat device" means any element of design which senses temperature, vehicle speed, engine rotational speed, transmission gear, manifold vacuum or any other parameter for the purpose of activating, modulating, delaying or deactivating the operation of any part of the emission control system, that reduces the effectiveness of the emission control system under conditions which may reasonably be expected to be encountered in normal vehicle operation and use. Such an element of design may not be considered a defeat device if:
- 2.16.1. the need for the device is justified in terms of protecting the engine against damage or accident and for safe operation of the vehicle, or
- 2.16.2. the device does not function beyond the requirements of engine starting, or
- 2.16.3. conditions are substantially included in the Type I or Type VI test procedures.
- 2.17. "Family of vehicles" means a group of vehicle types identified by a parent vehicle for the purpose of Annex 12.
- 2.18. "Fuel requirement by the engine" means the type of fuel normally used by the engine:
- petrol,
 - LPG (liquefied petroleum gas),
 - NG (natural gas),
 - either petrol or LPG,
 - either petrol or NG,
 - diesel fuel.
- 2.19. "Approval of a vehicle" means the approval of a vehicle type with regard to the limitation of the following conditions: 1/
- 2.19.1. limitation of exhaust emissions by the vehicle, evaporative emissions, crankcase emissions, durability of pollution control devices, cold start pollutant emissions and on-board diagnostics of vehicles fuelled with unleaded petrol, or which can be fuelled with either unleaded petrol and LPG or NG (**Approval B**).
- 2.19.2. limitation of emissions of gaseous and particulate pollutants, durability of pollution

1/ Approval A cancelled. The 05 series of amendments to the Regulation prohibit the use of leaded petrol.

control devices and on-board diagnostics of vehicles fuelled with diesel fuel (**Approval C**).

2.19.3. limitation of emissions of gaseous pollutants by the engine, crankcase emissions, durability of pollution control devices, cold start emissions and on-board diagnostics of vehicles fuelled with LPG or NG (**Approval D**).

2.20. “Periodically regenerating system” means an anti-pollution device (e.g. catalytic converter, particulate trap) that requires a periodical regeneration process in less than 4,000 km of normal vehicle operation. During cycles where regeneration occurs, emission standards can be exceeded. If a regeneration of an anti-pollution device occurs at least once per Type I test and that has already regenerated at least once during vehicle preparation cycle, it will be considered as a continuously regenerating system which does not require a special test procedure. Annex 13 does not apply to continuously regenerating systems.

At the request of the manufacturer, the test procedure specific to periodically regenerating systems will not apply to a regenerative device if the manufacturer provides data to the type approval authority that, during cycles where regeneration occurs, emissions remain below the standards given in paragraph 5.3.1.4. applied for the concerned vehicle category after agreement of the technical service.

2.21. Hybrid vehicles (HV)

2.21.1. General definition of hybrid vehicles (HV):

“Hybrid vehicle (HV)” means a vehicle with at least two different energy converters and two different energy storage systems (on vehicle) for the purpose of vehicle propulsion.

2.21.2. Definition of hybrid electric vehicles (HEV):

“Hybrid electric vehicle (HEV)” means a vehicle that, for the purpose of mechanical propulsion, draws energy from both of the following on-vehicle sources of stored energy/power:

- a consumable fuel
- an electrical energy/power storage device (e.g. battery, capacitor, flywheel/generator, etc.).

2.22. “Mono-fuel vehicle” means a vehicle that is designed primarily for permanent running on LPG or NG, but may also have a petrol system for emergency purposes for starting only, where the petrol tank does not contain more than 15 litres of petrol;

- 2.23. “Bi-fuel vehicle” means a vehicle that can run part-time on petrol and also part-time on either LPG or NG.

3. APPLICATION FOR APPROVAL

- 3.1. The application for approval of a vehicle type with regard to exhaust emissions, crankcase emissions, evaporative emissions and durability of pollution control devices, as well as to its on-board diagnostic (OBD) system shall be submitted by the vehicle manufacturer or by his authorised representative.
- 3.1.1. Should the application concern an on-board diagnostic (OBD) system, it shall be accompanied by the additional information required in paragraph 4.2.11.2.7. of Annex 1, together with:
- 3.1.1.1. a declaration by the manufacturer of:
- 3.1.1.1.1. in the case of vehicles equipped with positive-ignition engines, the percentage of misfires out of a total number of firing events that would result in emissions exceeding the limits given in paragraph 3.3.2. of Annex 11, if that percentage of misfire had been present from the start of a Type I test as described in paragraph 5.3.1. of Annex 4;
- 3.1.1.1.2. in the case of vehicles equipped with positive-ignition engines, the percentage of misfires out of a total number of firing events that could lead to an exhaust catalyst, or catalysts, overheating prior to causing irreversible damage;
- 3.1.1.2. detailed written information fully describing the functional operation characteristics of the OBD system, including a listing of all relevant parts of the vehicle's emission control system, i. e. sensors, actuators and components, that are monitored by the OBD system;
- 3.1.1.3. a description of the malfunction indicator (MI) used by the OBD system to signal the presence of a fault to a driver of the vehicle;
copies of other type approvals with the relevant data to enable extensions of approvals;
- 3.1.1.4. if applicable, the particulars of the vehicle family as referred to in Annex 11, Appendix 2.
- 3.1.2. For the tests described in paragraph 3. of Annex 11, a vehicle representative of the vehicle type or vehicle family fitted with the OBD system to be approved shall be submitted to the technical service responsible for the type approval test. If the

technical service determines that the submitted vehicle does not fully represent the vehicle type or vehicle family described in Annex 11, Appendix 2, an alternative and if necessary an additional vehicle shall be submitted for test in accordance with paragraph 3. of Annex 11.

- 3.2. A model of the information document relating to exhaust emissions, evaporative emissions, durability and the on-board diagnostic (OBD) system is given in Annex 1. The information mentioned under paragraph 4.2.11.2.7.6. of Annex 1 is to be included in Appendix 1 "OBD - RELATED INFORMATION" to the type-approval communication given in Annex 2.
- 3.2.1. Where appropriate, copies of other type approvals with the relevant data to enable extensions of approvals and establishment of deterioration factors shall be submitted.
- 3.3. For the tests described in paragraph 5. of this Regulation a vehicle representative of the vehicle type to be approved shall be submitted to the technical service responsible for the approval tests.

4. APPROVAL

- 4.1. If the vehicle type submitted for approval following this amendment meets the requirements of paragraph 5. below, approval of that vehicle type shall be granted.
- 4.2. An approval number shall be assigned to each type approved. Its first two digits shall indicate the series of amendments according to which the approval was granted. The same Contracting Party shall not assign the same number to another vehicle type.
- 4.3. Notice of approval or of extension or refusal of approval of a vehicle type pursuant to this Regulation shall be communicated to the Parties to the Agreement which apply this Regulation by means of a form conforming to the model in Annex 2 to this Regulation.
 - 4.3.1. In the event of amendment to the present text, for example, if new limit values are prescribed, the Parties to the Agreement shall be informed which vehicle types already approved comply with the new provisions.
- 4.4. There shall be affixed, conspicuously and in a readily accessible place specified on the approval form, to every vehicle conforming to a vehicle type approved under this Regulation, an international approval mark consisting of:

- 4.4.1. a circle surrounding the letter "E" followed by the distinguishing number of the country that has granted approval; 2/
- 4.4.2. the number of this Regulation, followed by the letter "R", a dash and the approval number to the right of the circle described in paragraph 4.4.1.
- 4.4.3. However, the approval mark shall contain an additional character after the letter "R", the purpose of which is to distinguish the emission limit values for which the approval has been granted. For those approvals issued to indicate compliance with the limits for the Type I test detailed in Row A of the table in paragraph 5.3.1.4.1. of this Regulation, the letter "R" will be followed by the roman number "I". For those approvals issued to indicate compliance with the limits for the Type I test detailed in Row B in the table to paragraph 5.3.1.4.1. of this Regulation, the letter "R" will be followed by the roman number "II".
- 4.5. If the vehicle conforms to a vehicle type approved, under one or more other Regulations Annexed to the Agreement, in the country which has granted approval under this Regulation, the symbol prescribed in paragraph 4.4.1. need not be repeated; in such a case, the Regulation and approval numbers and the additional symbols of all the Regulations under which approval has been granted in the country which has granted approval under this Regulation shall be placed in vertical columns to the right of the symbol prescribed in paragraph 4.4.1.
- 4.6. The approval mark shall be clearly legible and be indelible.
- 4.7. The approval mark shall be placed close to or on the vehicle data plate.
- 4.8. Annex 3 to this Regulation gives examples of arrangements of the approval mark.

2/ 1 for Germany, 2 for France, 3 for Italy, 4 for the Netherlands, 5 for Sweden, 6 for Belgium, 7 for Hungary, 8 for the Czech Republic, 9 for Spain, 10 for Yugoslavia, 11 for the United Kingdom, 12 for Austria, 13 for Luxembourg, 14 for Switzerland, 15 (vacant), 16 for Norway, 17 for Finland, 18 for Denmark, 19 for Romania, 20 for Poland, 21 for Portugal, 22 for the Russian Federation, 23 for Greece, 24 for Ireland, 25 for Croatia, 26 for Slovenia, 27 for Slovakia, 28 for Belarus, 29 for Estonia, 30 (vacant), 31 for Bosnia and Herzegovina, 32 for Latvia, 33 (vacant), 34 for Bulgaria, 35 (vacant), 36 for Lithuania, 37 for Turkey, 38 (vacant), 39 for Azerbaijan, 40 for The former Yugoslav Republic of Macedonia, 41 (vacant), 42 for the European Community (Approvals are granted by its Member States using their respective ECE symbol), 43 for Japan, 44 (vacant), 45 for Australia, 46 for Ukraine, 47 for South Africa and 48 for New Zealand. Subsequent numbers shall be assigned to other countries in the chronological order in which they ratify or accede to the Agreement Concerning the Adoption of Uniform Technical Prescriptions for Wheeled Vehicles, Equipment and Parts which can be Fitted and/or be Used on Wheeled Vehicles and the Conditions for Reciprocal Recognition of Approvals Granted on the Basis of these Prescriptions, and the numbers thus assigned shall be communicated by the Secretary-General of the United Nations to the Contracting Parties to the Agreement.

5. SPECIFICATIONS AND TESTS

Note: As an alternative to the requirements of this paragraph, vehicle manufacturers whose world-wide annual production is less than 10,000 units may obtain approval on the basis of the corresponding technical requirements specified in: the California Code of Regulations, Title 13, Paragraphs 1960.1 (f) (2) or (g) (1) and (g) (2), 1960.1 (p) applicable to 1996 and later model-year vehicles, 1968.1, 1976 and 1975, applicable to 1995 and later model year light-duty vehicles (California Code of Regulations is published by Barclays Publishing).

5.1. General

- 5.1.1. The components liable to affect the emission of pollutants shall be so designed, constructed and assembled as to enable the vehicle, in normal use, despite the vibration to which they may be subjected, to comply with the provisions of this Regulation.
- 5.1.2. The technical measures taken by the manufacturer shall be such as to ensure that in conformity with the provisions of this Regulation, exhaust gas and evaporative emissions are effectively limited throughout the normal life of the vehicle and under normal conditions of use. This will include the security of those hoses and their joints and connections, used within the emission control systems, which shall be so constructed as to conform with the original design intent. For exhaust emissions, these provisions are deemed to be met if the provisions of paragraphs 5.3.1.4. and 8.2.3.1. respectively are complied with. For evaporative emissions, these conditions are deemed to be met if the provisions of paragraphs 5.3.1.4. and 8.2.3.1. respectively are complied with.
- 5.1.2.1. The use of a defeat device is prohibited.
- 5.1.3. Inlet orifices of petrol tanks
- 5.1.3.1. Subject to paragraph 5.1.3.2., the inlet orifice of the petrol tank shall be so designed as to prevent the tank from being filled from a petrol pump delivery nozzle which has an external diameter of 23.6 mm or greater.
- 5.1.3.2. Paragraph 5.1.3.1. shall not apply to a vehicle in respect of which both of the following conditions are satisfied, i.e.:
- 5.1.3.2.1. the vehicle is so designed and constructed that no device designed to control the emission of gaseous pollutants shall be adversely affected by leaded petrol, and;

5.1.3.2.2. the vehicle is conspicuously, legibly and indelibly marked with the symbol for unleaded petrol, specified in ISO 2575:1982, in a position immediately visible to a person filling the petrol tank. Additional markings are permitted.

5.1.4. Provision shall be made to prevent excess evaporative emissions and fuel spillage caused by a missing fuel filler cap.

This may be achieved by using one of the following:

5.1.4.1. an automatically opening and closing, non-removable fuel filler cap;

5.1.4.2. design features which avoid excess evaporative emissions in the case of a missing fuel filler cap;

5.1.4.3. any other provision which has the same effect. Examples may include, but are not limited to, a tethered filler cap, a chained filler cap or one utilising the same locking key for the filler cap as for the vehicle's ignition. In this case, the key shall be removable from the filler cap only in the locked condition.

5.1.5. Provisions for electronic system security

5.1.5.1. Any vehicle with an emission control computer shall include features to deter modification, except as authorised by the manufacturer. The manufacturer shall authorise modifications if these modifications are necessary for the diagnosis, servicing, inspection, retrofitting or repair of the vehicle. Any reprogrammable computer codes or operating parameters shall be resistant to tampering and afford a level of protection at least as good as the provisions in ISO DIS 15031-7, dated October 1998 (SAE J2186 dated October 1996), provided that the security exchange is conducted using the protocols and diagnostic connector as prescribed in paragraph 6.5. of Annex II, Appendix 1. Any removable calibration memory chips shall be potted, encased in a sealed container or protected by electronic algorithms and shall not be changeable without the use of specialised tools and procedures.

5.1.5.2. Computer-coded engine operating parameters shall not be changeable without the use of specialised tools and procedures (e.g. soldered or potted computer components or sealed (or soldered) computer enclosures).

5.1.5.3. In the case of mechanical fuel-injection pumps fitted to compression-ignition engines, manufacturers shall take adequate steps to protect the maximum fuel delivery setting from tampering while a vehicle is in service.

5.1.5.4. Manufacturers may apply to the approval authority for an exemption to one of these requirements for those vehicles which are unlikely to require protection. The

criteria that the approval authority will evaluate in considering an exemption will include, but are not limited to, the current availability of performance chips, the high-performance capability of the vehicle and the projected sales volume of the vehicle.

5.1.5.5. Manufacturers using programmable computer code systems (e.g. Electrical Erasable Programmable Read-Only Memory, EEPROM) shall deter unauthorised reprogramming. Manufacturers shall include enhanced tamper protection strategies and write protect features requiring electronic access to an off-site computer maintained by the manufacturer. Methods giving an adequate level of tamper protection will be approved by the authority.

5.1.6. It shall be possible to inspect the vehicle for roadworthiness test in order to determine its performance in relation to the data collected in accordance with paragraph 5.3.7. to this Regulation. If this inspection requires a special procedure, this shall be detailed in the service manual (or equivalent media). This special procedure shall not require the use of special equipment other than that provided with the vehicle.

5.2. Test procedure

Table 1 illustrates the various possibilities for type approval of a vehicle.

5.2.1. Positive-ignition engine-powered vehicles and hybrid electric vehicles equipped with a positive-ignition engine shall be subject to the following tests:

Type I (verifying the average exhaust emissions after a cold start),

Type II (carbon monoxide emission at idling speed),

Type III (emission of crankcase gases),

Type IV (evaporation emissions),

Type V (durability of anti-pollution devices),

Type VI (verifying the average low ambient temperature carbon monoxide and hydrocarbon exhaust emissions after a cold start,

OBD-test.

5.2.2. Positive-ignition engine powered vehicles and hybrid electric vehicles equipped with a positive-ignition engine fuelled with LPG or NG (mono or bi-fuel) shall be subject to the following tests (according to Table 1):

Type I (verifying the average exhaust emissions after a cold start),

Type II (carbon monoxide emissions at idling speed),

Type III (emission of crankcase gases),

Type IV (evaporative emissions), where applicable,

Type V (durability of anti-pollution devices),

Type VI (verifying the average low ambient temperature carbon monoxide and hydrocarbon exhaust emissions after a cold start), where applicable,

OBD test, where applicable.

5.2.3. Compression-ignition engine-powered vehicles and hybrid electric vehicles equipped with a compression ignition engine shall be subject to the following tests:

Type I (verifying the average exhaust emissions after a cold start)

Type V (durability of anti-pollution control devices)

and, where applicable, OBD test.

5.3. Description of tests

5.3.1. **Type I test** (Simulating the average exhaust emissions after a cold start).

5.3.1.1. Figure 1 illustrates the routes for Type I test. This test shall be carried out on all vehicles referred to in paragraph 1., having a maximum mass not exceeding 3.5 tonnes.

5.3.1.2. The vehicle is placed on a chassis dynamometer equipped with a means of load and inertia simulation.

5.3.1.2.1. A test lasting a total of 19 minutes and 40 seconds, made up of two parts, One and Two, is performed without interruption. An unsampled period of not more than 20 seconds may, with the agreement of the manufacturer, be introduced between the end of Part One and the beginning of Part Two in order to facilitate adjustment of the test equipment.

5.3.1.2.1.1. Vehicles that are fuelled with LPG or NG shall be tested in the Type I test for variation in the composition of LPG or NG, as set out in Annex 12. Vehicles

that can be fuelled either with petrol or LPG or NG shall be tested on both the fuels, tests on LPG or NG being performed for variation in the composition of LPG or NG, as set out in Annex 12.

- 5.3.1.2.1.2. Notwithstanding the requirement of paragraph 5.3.1.2.1.1., vehicles that can be fuelled with either petrol or a gaseous fuel, but where the petrol system is fitted for emergency purposes or starting only and which the petrol tank cannot contain more than 15 litres of petrol will be regarded for the test Type I as vehicles that can only run on a gaseous fuel.
- 5.3.1.2.2. Part One of the test is made up of four elementary urban cycles. Each elementary urban cycle comprises fifteen phases (idling, acceleration, steady speed, deceleration, etc.).
- 5.3.1.2.3. Part Two of the test is made up of one extra-urban cycle. The extra-urban cycle comprises 13 phases (idling, acceleration, steady speed, deceleration, etc.).

Table 1

Different routes for type approval and extensions

Type-approval test	Positive-ignition engined vehicles of categories M and N			Compression-ignition engined vehicles of categories M ₁ and N ₁
	petrol fuelled vehicle	bi-fuel vehicle	mono-fuel vehicle	
Type I	Yes (maximum mass ≤ 3.5 t)	Yes (test with both fuel types) (maximum mass ≤ 3.5 t)	Yes (maximum mass ≤ 3.5 t)	Yes (maximum mass ≤ 3.5 t)
Type II	Yes	Yes (test with both fuel types)	Yes	-
Type III	Yes	Yes (test only with petrol)	Yes	-
Type IV	Yes (maximum mass ≤ 3.5 t)	Yes (test only with petrol) (maximum mass ≤ 3.5 t)	-	-
Type V	Yes (maximum mass ≤ 3.5 t)	Yes (test only with petrol) (maximum mass ≤ 3.5 t)	Yes (maximum mass ≤ 3.5 t)	Yes (maximum mass ≤ 3.5 t)
Type VI	Yes (maximum mass ≤ 3.5 t)	Yes (maximum mass ≤ 3.5 t) (test only with petrol)	-	-
Extension	Paragraph 7.	Paragraph 7.	Paragraph 7.	Paragraph 7.; M ₂ and N ₂ with a reference mass ≤ 2,840 kg .
On-board diagnostics	Yes, in accordance with paragraph 11.1.5.1.1. or 11.1.5.3.	Yes, in accordance with paragraph 11.1.5.1.2. or 11.1.5.3.	Yes, in accordance with paragraph 11.1.5.1.2. or 11.1.5.3.	Yes, in accordance with paragraph 11.1.5.2.1 or 11.1.5.2.2. or 11.1.5.2.3. or 11.1.5.3

5.3.1.2.4. During the test, the exhaust gases are diluted and a proportional sample collected in one or more bags. The exhaust gases of the vehicle tested are diluted, sampled and analysed, following the procedure described below, and the total volume of the diluted exhaust is measured. Not only the carbon monoxide, hydrocarbon and nitrogen oxide emissions, but also the particulate pollutant emissions from vehicles equipped with compression-ignition engines are recorded.

5.3.1.3. The test is carried out using the procedure described in Annex 4. The methods used to collect and analyse the gases and to remove and weigh the particulates shall be as prescribed.

5.3.1.4. Subject to the requirements of paragraph 5.3.1.5., the test shall be repeated three times. The results are multiplied by the appropriate deterioration factors obtained from paragraph 5.3.6. and, in the case of periodically regenerating systems as defined in paragraph 2.20., also must be multiplied by the factors K_i obtained from Annex 13. The resulting masses of gaseous emissions and, in the case of vehicles equipped with compression-ignition engines, the mass of particulates obtained in each test shall be less than the limits shown in the table below:

Limit Values

Category	Class	Reference mass (RW) (kg)	Mass of carbon monoxide (CO)		Mass of hydrocarbons (HC)		Mass of oxides of nitrogen (NO _x)		Combined mass of hydrocarbons and oxides of nitrogen (HC + NO _x)		Mass of particulates ⁽¹⁾ (PM)	
			L ₁ (g/km)		L ₂ (g/km)		L ₃ (g/km)		L ₂ + L ₃ (g/km)		L ₄ (g/km)	
			Petrol	Diesel	Petrol	Diesel	Petrol	Diesel	Petrol	Diesel	Diesel	
A(2000)	M ⁽²⁾	-	All	2.3	0.64	0.20	-	0.15	0.50	-	0.56	0.05
	N ₁ ⁽³⁾	I	RW ≤ 1305	2.3	0.64	0.20	-	0.15	0.50	-	0.56	0.05
		II	1305 < RW ≤ 1760	4.17	0.80	0.25	-	0.18	0.65	-	0.72	0.07
		III	1760 < RW	5.22	0.95	0.29	-	0.21	0.78	-	0.86	0.10
B(2005)	M ⁽²⁾	-	All	1.0	0.50	0.10	-	0.08	0.25	-	0.30	0.025
	N ₁ ⁽³⁾	I	RW ≤ 1305	1.0	0.50	0.10	-	0.08	0.25	-	0.30	0.025
		II	1305 < RW ≤ 1760	1.81	0.63	0.13	-	0.10	0.33	-	0.39	0.04
		III	1760 < RW	2.27	0.74	0.16	-	0.11	0.39	-	0.46	0.06

- (1) For compression-ignition engines.
(2) Except vehicles the maximum mass of which exceeds 2,500 kg.
(3) And those category M vehicles which are specified in note (2).

5.3.1.4.1. Notwithstanding the requirements of paragraph 5.3.1.4., for each pollutant or combination of pollutants, one of the three resulting masses obtained may exceed, by not more than 10 per cent, the limit prescribed, provided the arithmetical mean of the three results is below the prescribed limit. Where the prescribed limits are exceeded for more than one pollutant, it is immaterial whether this occurs in the same test or in different tests.

5.3.1.4.2. When the tests are performed with gaseous fuels, the resulting mass of gaseous emissions shall be less than the limits for petrol-engined vehicles in the above table.

5.3.1.5. The number of tests prescribed in paragraph 5.3.1.4. is reduced in the conditions hereinafter defined, where V_1 is the result of the first test and V_2 the result of the second test for each pollutant or for the combined emission of two pollutants subject to limitation.

5.3.1.5.1. Only one test is performed if the result obtained for each pollutant or for the combined emission of two pollutants subject to limitation, is less than or equal to 0.70 L (i.e. $V_1 \leq 0.70$ L).

5.3.1.5.2. If the requirement of paragraph 5.3.1.5.1. is not satisfied, only two tests are performed if, for each pollutant or for the combined emission of two pollutants subject to limitation, the following requirements are met:

$$V_1 \leq 0.85 \text{ L and } V_1 + V_2 \leq 1.70 \text{ L and } V_2 \leq L.$$

5.3.2. **Type II test** (Carbon monoxide emission test at idling speed)

5.3.2.1. This test is carried out on all vehicles powered by positive-ignition engines having a maximum mass exceeding 3.5 tonnes.

5.3.2.1.1. Vehicles that can be fuelled either with petrol or with LPG or NG shall be tested in the test Type II on both fuels.

5.3.2.1.2. Notwithstanding the requirement of paragraph 5.3.2.1.1., vehicles that can be fuelled with either petrol or a gaseous fuel, but where the petrol system is fitted for emergency purposes or starting only and which the petrol tank cannot contain more than 15 litres of petrol will be regarded for the test Type II as vehicles that can only run on a gaseous fuel.

5.3.2.2. When tested in accordance with Annex 5, the carbon monoxide content by volume of the exhaust gases emitted with the engine idling shall not exceed 3.5 per cent at the setting specified by the manufacturer and shall not exceed 4.5 per cent within the range of adjustments specified in that Annex.

5.3.3. **Type III test** (verifying emissions of crankcase gases)

5.3.3.1. This test shall be carried out on all vehicles referred to in paragraph 1. except those having compression-ignition engines.

- 5.3.3.1.1. Vehicles that can be fuelled either with petrol or with LPG or NG should be tested in the Type III test on petrol only.
- 5.3.3.1.2. Notwithstanding the requirement of paragraph 5.3.3.1.1., vehicles that can be fuelled with either petrol or a gaseous fuel, but where the petrol system is fitted for emergency purposes or starting only and which the petrol tank cannot contain more than 15 litres of petrol will be regarded for the test Type III as vehicles that can only run on a gaseous fuel.

Figure 1

Flow chart for Type I type approval

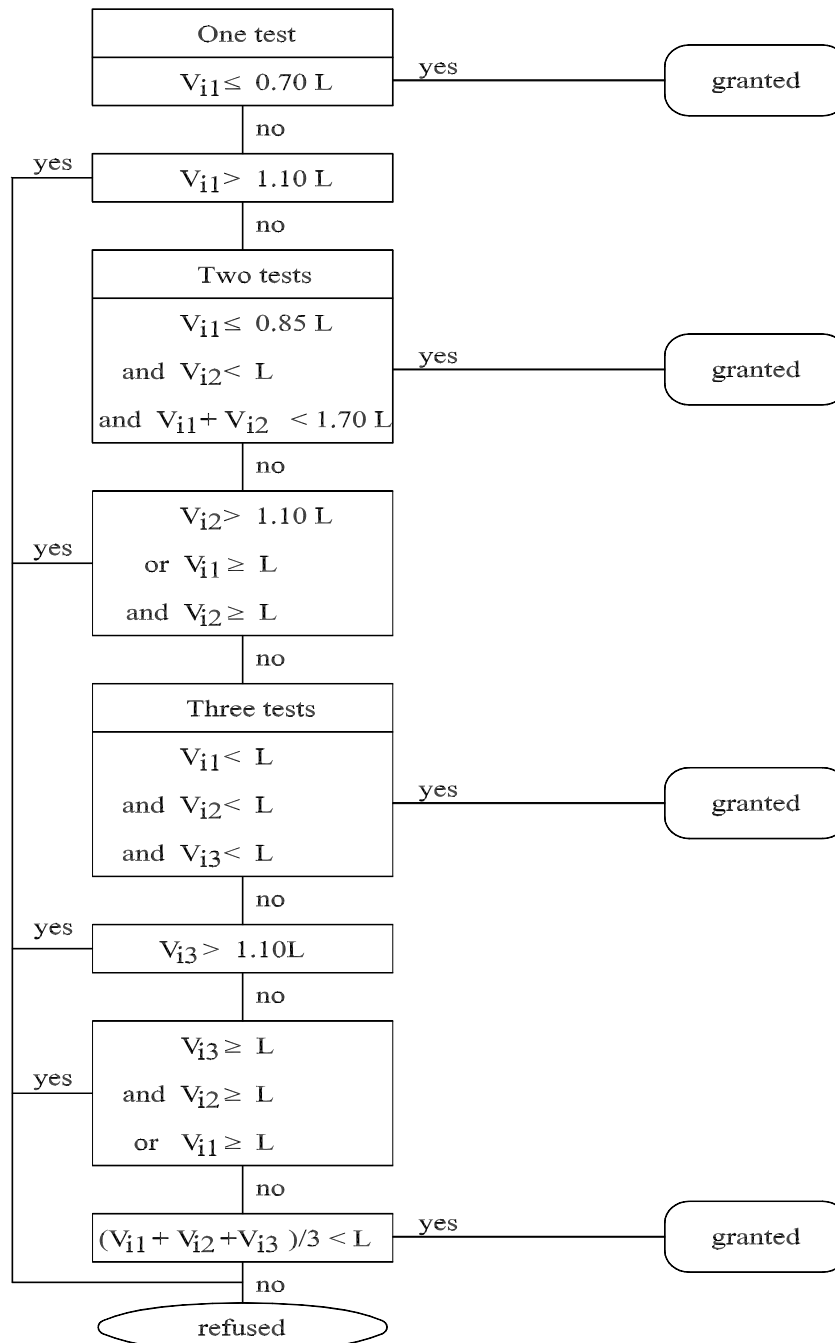

(see paragraph 5.3.1.)

- 5.3.3.2. When tested in accordance with Annex 6, the engine's crankcase ventilation system shall not permit the emission of any of the crankcase gases into the atmosphere.
- 5.3.4. **Type IV test** (Determination of evaporative emissions)
- 5.3.4.1. This test shall be carried out on all vehicles referred to in paragraph 1. except those vehicles having a compression-ignition engine, vehicles fuelled with LPG or NG and those vehicles with a maximum mass greater than 3,500 kg.
- 5.3.4.1.1. Vehicles that can be fuelled either with petrol or with LPG or NG should be tested in the Type IV test on petrol only.
- 5.3.4.2. When tested in accordance with Annex 7, evaporative emissions shall be less than 2 g/test.
- 5.3.5. **Type VI test** (Verifying the average low ambient temperature carbon monoxide and hydrocarbon exhaust emissions after a cold start).
- 5.3.5.1. This test shall be carried out on all M₁ and N₁ Class I vehicles equipped with a positive-ignition engine, except vehicles designed to carry more than six occupants and vehicles whose maximum mass exceeds 2,500 kg.
- 5.3.5.1.1. The vehicle is placed on a chassis dynamometer equipped with a means of load an inertia simulation.
- 5.3.5.1.2. The test consists of the four elementary urban driving cycles of Part One of the Type I test. The Part One test is described in Annex 4, Appendix 1 and illustrated in figures 1/1, 1/2 and 1/3 of the Appendix. The low ambient temperature test lasting a total of 780 seconds shall be carried out without interruption and start at engine cranking.
- 5.3.5.1.3. The low ambient temperature test shall be carried out at an ambient test temperature of 266 K (-7°C). Before the test is carried out, the test vehicles shall be conditioned in a uniform manner to ensure that the test results may be reproducible. The conditioning and other test procedures are carried out as described in Annex 8.
- 5.3.5.1.4. During the test, the exhaust gases are diluted and a proportional sample collected. The exhaust gases of the vehicle tested are diluted, sampled and analysed, following the procedure described in Annex 8, and the total volume of the diluted exhaust is measured. The diluted exhaust gases are analysed for carbon monoxide and hydrocarbons.

- 5.3.5.2. Subject to the requirements in paragraphs 5.3.5.2.2. and 5.3.5.3. the test shall be performed three times. The resulting mass of carbon monoxide and hydrocarbon emission shall be less than the limits shown in the table below:

Test temperature	Carbon monoxide L1 (g/km)	Hydrocarbons L2 (g/km)
266 K (-7 °C)	15	1.8

- 5.3.5.2.1. Notwithstanding the requirements of paragraph 5.3.5.2., for each pollutant, not more than one of the three results obtained may exceed the limit prescribed by not more than 10 per cent, provided the arithmetical mean value of the three results is below the prescribed limit. Where the prescribed limits are exceeded for more than one pollutant, it is immaterial whether this occurs in the same test or in different tests.
- 5.3.5.2.2. The number of tests prescribed in paragraph 5.3.5.2. may, at the request of the manufacturer, be increased to 10 if the arithmetical mean of the first three results is lower than 110 per cent of the limit. In this case, the requirement after testing is only that the arithmetical mean of all 10 results shall be less than the limit value.
- 5.3.5.3. The number of tests prescribed in paragraph 5.3.5.2. may be reduced according to paragraphs 5.3.5.3.1. and 5.3.5.3.2.
- 5.3.5.3.1. Only one test is performed if the result obtained for each pollutant of the first test is less than or equal to 0.70 L.
- 5.3.5.3.2. If the requirement of paragraph 5.3.5.3.1. is not satisfied, only two tests are performed if for each pollutant the result of the first test is less than or equal to 0.85 L and the sum of the first two results is less than or equal to 1.70 L and the result of the second test is less than or equal to L.

$$(V_1 \leq 0.85 \text{ L and } V_1 + V_2 \leq 1.70 \text{ L and } V_2 \leq L).$$

- 5.3.6. **Type V test** (Durability of anti-pollution devices)

- 5.3.6.1. This test shall be carried out on all vehicles referred to in paragraph 1. to which the test specified in paragraph 5.3.1. applies. The test represents an ageing test of 80,000 kilometres driven in accordance with the programme described in Annex 9 on a test track, on the road or on a chassis dynamometer.

5.3.6.1.1. Vehicles that can be fuelled either with petrol or with LPG or NG should be tested in the Type V test on petrol only. In that case the deterioration factor found with unleaded petrol will also be taken for LPG or NG.

5.3.6.2. Notwithstanding the requirement of paragraph 5.3.6.1., a manufacturer may choose to have the deterioration factors from the following table used as an alternative to testing to paragraph 5.3.6.1.

Engine category	Deterioration factors by pollutant				
	CO	HC	NO _x	HC + NO _x ⁽¹⁾	Particulates
Positive- ignition engine	1.2	1.2	1.2	-	-
Compression- ignition engine	1.1	-	1	1	1.2

(1) For compression ignition engined vehicles

At the request of the manufacturer, the technical service may carry out the Type I test before the Type V test has been completed using the deterioration factors in the table above. On completion of the Type V test, the technical service may then amend the type approval results recorded in Annex 2 by replacing the deterioration factors in the above table with those measured in the Type V test.

5.3.6.3. Deterioration factors are determined using either procedure in paragraph 5.3.6.1. or using the values in the table in paragraph 5.3.6.2. The factors are used to establish compliance with the requirements of paragraphs 5.3.1.4. and 8.2.3.1.

5.3.7. Emission data required for roadworthiness testing

5.3.7.1. This requirement applies to all vehicles powered by a positive-ignition engine for which type approval is sought in accordance with this amendment.

5.3.7.2. When tested in accordance with Annex 5 (Type II test) at normal idling speed:

- (a) the carbon monoxide content by volume of the exhaust gases emitted shall be recorded,
- (b) the engine speed during the test shall be recorded, including any

tolerances.

5.3.7.3. When tested at 'high idle' speed (i. e. > 2,000 min.⁻¹)

- (a) the carbon monoxide content by volume of the exhaust gases emitted shall be recorded,
- (b) the Lambda value (*) shall be recorded.
- (c) the engine speed during the test shall be recorded, including any tolerances.
- (*) The Lambda value shall be calculated using the simplified Brettschneider equation as follows:

$$\lambda = \frac{[\text{CO}_2] + \frac{[\text{CO}]}{2} + [\text{O}_2] + \left(\frac{\text{Hcv}}{4} \cdot \frac{3.5}{3.5 + \frac{[\text{CO}]}{[\text{CO}_2]}} - \frac{\text{Ocv}}{2} \right) \cdot ([\text{CO}_2] + [\text{CO}])}{\left(1 + \frac{\text{Hcv}}{4} - \frac{\text{Ocv}}{2} \right) \cdot ([\text{CO}_2] + [\text{CO}] + \text{K1} \cdot [\text{HC}])}$$

where:

[] = Concentration in per cent volume

K1 = Conversion factor for NDIR measurement to FID measurement (provided by manufacturer of measuring equipment)

H_{cv} = Atomic ratio of hydrogen to carbon

- for petrol 1.73
- for LPG 2.53
- for NG 4.0

O_{cv} = Atomic ratio of oxygen to carbon

- for petrol 0.02
- for LPG 0.0
- for NG 0.0

5.3.7.4. The engine oil temperature at the time of the test shall be measured and recorded.

5.3.7.5. The table in item 17 to Annex 2 shall be completed.

5.3.7.6. The manufacturer shall confirm the accuracy of the Lambda value recorded at the time of type approval in paragraph 5.3.7.3. as being representative of typical production vehicles within 24 months of the date of the granting of type approval by the competent authority. An assessment shall be made based on surveys and studies of production vehicles.

5.3.8 OBD – test

This test shall be carried out on all vehicles referred to in paragraph 1. The test procedure described in Annex 11, paragraph 3. shall be followed.

6. **MODIFICATIONS OF THE VEHICLE TYPE**

6.1. Every modification of the vehicle type shall be notified to the administrative department that approved the vehicle type. The department may then either:

6.1.1. consider that the modifications made are unlikely to have an appreciable adverse effect and that in any case the vehicle still complies with the requirement; or

6.1.2. require a further test report from the technical service responsible for conducting the tests.

6.2. Confirmation or refusal of approval, specifying the alterations, shall be communicated by the procedure specified in paragraph 4.3. above to the Parties to the Agreement which apply this Regulation.

6.3. The competent authority issuing the extension of approval shall assign a series number to the extension and inform thereof the other Parties to the 1958 Agreement applying this Regulation by means of a communication form conforming to the model in Annex 2 to this Regulation.

7. **EXTENSION OF APPROVAL**

In the case of modifications of the type approval pursuant to this Regulation, the following special provisions shall apply, if applicable.

7.1. Exhaust emission related extensions
(Type I, Type II and Type VI tests).

7.1.1. Vehicle types of different reference masses

7.1.1.1. Approval granted to a vehicle type may be extended only to vehicle types of a reference mass requiring the use of the next two higher equivalent inertia categories or any lower equivalent inertia category.

7.1.1.2. In the case of vehicles of category N₁ and vehicles of category M referred to in note 2 of paragraph 5.3.1.4., if the reference mass of the vehicle type for which extension of the approval is requested requires the use of equivalent inertia lower than that used for the vehicle type already approved, extension of the approval is granted if the masses of the pollutants obtained from the vehicle already approved are within the limits prescribed for the vehicle for which extension of the approval is requested.

7.1.2. Vehicle types with different overall gear ratios

Approval granted to a vehicle type may under the following conditions be extended to vehicle types which differ from the type approved only in respect of their transmission ratios:

7.1.2.1. For each of the transmission ratios used in the Type I and Type VI test, it is necessary to determine the proportion,

$$E = \frac{|V_2 - V_1|}{V_1}$$

where, at an engine speed of 1,000 rpm, V₁ is the speed of the vehicle type approved and V₂ is the speed of the vehicle type for which extension of the approval is requested.

7.1.2.2. If, for each gear ratio, $E \leq 8$ per cent, the extension is granted without repeating the Type I and Type VI tests.

7.1.2.3. If, for at least one gear ratio, $E > 8$ per cent and if for each gear ratio $E \pm 13$ per cent the Type I and Type VI test shall be repeated, but may be performed in a laboratory chosen by the manufacturer subject to the approval of the technical service. The report of the tests shall be sent to the technical service responsible for the type approval tests.

7.1.3. Vehicle types of different reference masses and different overall transmission ratios

Approval granted to a vehicle type may be extended to vehicle types differing from the approved type only in respect of their reference mass and their overall transmission ratios, provided that all the conditions prescribed in paragraphs 7.1.1. and 7.1.2. are fulfilled.

7.1.4. Note: When a vehicle type has been approved in accordance with paragraphs 7.1.1. to 7.1.3., such approval may not be extended to other vehicle types.

7.2. Evaporative emissions (Type IV test)

7.2.1. Approval granted to a vehicle type equipped with a control system for evaporative emissions may be extended under the following conditions:

7.2.1.1. The basic principle of fuel/air metering (e.g. single point injection, carburettor) shall be the same.

7.2.1.2. The shape of the fuel tank and the material of the fuel tank and liquid fuel hoses shall be identical. The worst-case family with regard to the cross-paragraph and approximate hose length shall be tested. Whether non-identical vapour/liquid separators are acceptable is decided by the technical service responsible for the type approval tests. The fuel tank volume shall be within a range of ± 10 per cent. The setting of the tank relief valve shall be identical.

7.2.1.3. The method of storage of the fuel vapour shall be identical, i.e. trap form and volume, storage medium, air cleaner (if used for evaporative emission control), etc.

7.2.1.4. The carburetor bowl fuel volume shall be within a ± 10 millilitre range.

7.2.1.5. The method of purging of the stored vapour shall be identical (e.g. air flow, start point or purge volume over driving cycle).

7.2.1.6. The method of sealing and venting of the fuel metering system shall be identical.

7.2.2. Further notes:

- (i) different engine sizes are allowed;
- (ii) different engine powers are allowed;
- (iii) automatic and manual gearboxes, two and four-wheel transmissions are allowed;
- (iv) different body styles are allowed;
- (v) different wheel and tyre sizes are allowed.

7.3. Durability of anti-pollution devices (Type V test)

7.3.1. Approval granted to a vehicle type may be extended to different vehicle types, provided that the engine/pollution control system combination is identical to that of the vehicle already approved. To this end, those vehicle types whose parameters

described below are identical or remain within the limit values prescribed are considered to belong to the same engine/pollution control system combination.

7.3.1.1. Engine:

number of cylinders,
engine capacity (± 15 per cent),
configuration of the cylinder block,
number of valves,
fuel system,
type of cooling system,
combustion process,
cylinder bore centre to centre dimensions.

7.3.1.2. Pollution control system:

catalytic converters:
number of catalytic converters and elements,
size and shape of catalytic converters (volume of monolith ± 10 per cent),
type of catalytic activity (oxidising, three-way,...),
precious metal load (identical or higher),
precious metal ratio (± 15 per cent),
substrate (structure and material),
cell density,
type of casing for the catalytic converter(s),
location of catalytic converters (position and dimension in the exhaust system, that does not produce a temperature variation of more than 50 K at the inlet of the catalytic converter).

This temperature variation shall be checked under stabilised conditions at a speed of 120 km/h and the load setting of Type I test.

Air injection: with or without

type (pulsair, air pumps,...).

Exhaust gas recirculation (EGR): with or without.

7.3.1.3. Inertia category: the two inertia categories immediately above and any inertia category below.

7.3.1.4. The durability test may be achieved by using a vehicle, the body style, gear box (automatic or manual) and size of the wheels or tyres of which are different from those of the vehicle type for which the type approval is sought.

7.4. On-board diagnostics

7.4.1. Approval granted to a vehicle type with respect to the OBD system may be extended to different vehicle types belonging to the same vehicle-OBD family as described in Annex 11, Appendix 2. The engine emission control system shall be identical to that of the vehicle already approved and comply with the description of the OBD engine family given in Annex 11, Appendix 2, regardless of the following vehicle characteristics:

engine accessories,

tyres,

equivalent inertia,

cooling system,

overall gear ratio,

transmission type,

type of bodywork.

8. **CONFORMITY OF PRODUCTION (COP)**

8.1. Every vehicle bearing an approval mark as prescribed under this Regulation shall conform, with regard to components affecting the emission of gaseous and

particulate pollutants by the engine, emissions from the crankcase and evaporative emissions, to the vehicle type approved. The conformity of production procedures shall comply with those set out in the 1958 Agreement, Appendix 2 (E/ECE/324-E/ECE/TRANS/505/Rev.2), with the following requirements:

- 8.2. As a general rule, conformity of production with regard to limitation of emissions from the vehicle (test Types I, II, III and IV) is checked based on the description given in the communication form and its Annexes.

Conformity of in-service vehicles

With reference to type approvals granted for emissions, these measures shall also be appropriate for confirming the functionality of the emission control devices during the normal useful life of the vehicles under normal conditions of use (conformity of in-service vehicles properly maintained and used). For the purpose of this Regulation these measures shall be checked for a period of up to 5 years of age or 80,000 km, whichever is the sooner, and from 1 January 2005, for a period of up to five years of age or 100,000 km, whichever is the sooner.

- 8.2.1. Audit of in-service conformity by the administrative department is conducted on the basis of any relevant information that the manufacturer has, under procedures similar to those defined in Appendix 2 of the 1958 Agreement (E/ECE/324-E/ECE/TRANS/505/Rev.2).

Figures 4/1 and 4/2, in Appendix 4, illustrate the procedure for in-service conformity checking.

- 8.2.1.1. Parameters defining the in-service family

The in-service family may be defined by basic design parameters which must be common to vehicles within the family. Accordingly, those vehicle types which have in common, or within the stated tolerances, at least the parameters described below, can be considered as belonging to the same in-service family:

- combustion process (2-stroke, 4-stroke, rotary);
- number of cylinders;
- configuration of the cylinder block (in-line, V, radial, horizontally opposed, other). The inclination or orientation of the cylinders is not a criterion;
- method of engine fuelling (e.g. indirect or direct injection);
- type of cooling system (air, water, oil);
- method of aspiration (naturally aspirated, pressure charged);
- fuel for which the engine is designed (petrol, diesel, NG, LPG, etc).
Bi-fuelled vehicles may be grouped with dedicated fuel vehicles providing one of the fuels is common;
- type of catalytic converter (three-way catalyst or other(s));

- type of particulate trap (with or without);
 - exhaust gas recirculation (with or without);
 - engine cylinder capacity of the largest engine within the family minus 30 per cent.
- 8.2.1.2. An audit of in-service conformity will be conducted by the administrative department on the basis of information supplied by the manufacturer. Such information must include, but is not limited to, the following:
- 8.2.1.2.1. The name and address of the manufacturer.
 - 8.2.1.2.2. The name, address, telephone and fax numbers and e-mail address of his authorised representative within the areas covered by the manufacturer's information.
 - 8.2.1.2.3. The model name(s) of the vehicles included in the manufacturer's information.
 - 8.2.1.2.4. Where appropriate, the list of vehicle types covered within the manufacturer's information, i.e. the in-service family group in accordance with paragraph 8.2.1.1.
 - 8.2.1.2.5. The vehicle identification number (VIN) codes applicable to these vehicle types within the in-service family (VIN prefix).
 - 8.2.1.2.6. The numbers of the type approvals applicable to these vehicle types within the in-service family, including, where applicable, the numbers of all extensions and field fixes/recalls (re-works);
 - 8.2.1.2.7. Details of extensions, field fixes/recalls to those type approvals for the vehicles covered within the manufacturer's information (if requested by the administrative department).
 - 8.2.1.2.8. The period of time over which the manufacturer's information was collected.
 - 8.2.1.2.9. The vehicle build period covered within the manufacturer's information (e.g. 'vehicles manufactured during the 2001 calendar year').
 - 8.2.1.2.10. The manufacturer's in-service conformity checking procedure, including:
 - 8.2.1.2.10.1. Vehicle location method;
 - 8.2.1.2.10.2. Vehicle selection and rejection criteria;
 - 8.2.1.2.10.3. Test types and procedures used for the programme;
 - 8.2.1.2.10.4. The manufacturer's acceptance/rejection criteria for the in-service family group;

- 8.2.1.2.10.5. Geographical area(s) within which the manufacturer has collected information.
- 8.2.1.2.10.6. Sample size and sampling plan used.
- 8.2.1.2.11. The results from the manufacturer's in-service conformity procedure, including:
- 8.2.1.2.11.1. Identification of the vehicles included in the programme (whether tested or not).
The identification will include:
- model name;
 - vehicle identification number (VIN);
 - vehicle registration number;
 - date of manufacture;
 - region of use (where known);
 - tyres fitted.
- 8.2.1.2.11.2. The reason(s) for rejecting a vehicle from the sample.
- 8.2.1.2.11.3. Service history for each vehicle in the sample (including any re-works).
- 8.2.1.2.11.4. Repair history for each vehicle in the sample (where known).
- 8.2.1.2.11.5. Test data, including:
- date of test;
 - location of test;
 - distance indicated on vehicle odometer;
 - test fuel specifications (e.g. test reference fuel or market fuel);
 - test conditions (temperature, humidity, dynamometer inertia weight);
 - dynamometer settings (e.g. power setting);
 - test results (from at least three different vehicles per family).
- 8.2.1.2.12. Records of indications from the OBD system.

8.2.2. The information gathered by the manufacturer must be sufficiently comprehensive to ensure that in-service performance can be assessed for normal conditions of use as defined in paragraph 8.2. and in a way representative of the manufacturer's geographic penetration.

For the purpose of this Regulation, the manufacturer shall not be obliged to carry out an audit of in-service conformity for a vehicle type if he can demonstrate to the satisfaction of the type-approval authority that the annual worldwide sales of that vehicle type are less than 10,000 per annum.

In the case of vehicles to be sold within the European Union, the manufacturer shall not be obliged to carry out an audit in-service conformity for a vehicle type if

he can demonstrate to the satisfaction of the type-approval authority that the annual sales of that vehicle type is less than 5,000 per annum within the European Union.

8.2.3. If a Type I test is to be carried out and a vehicle type approval has one or several extensions, the tests will be carried out either on the vehicle described in the initial information package or on the vehicle described in the information package relating to the relevant extension.

8.2.3.1. Checking the conformity of the vehicle for a Type I test.

After selection by the authority, the manufacturer shall not undertake any adjustment to the vehicles selected.

For hybrid electric vehicles (HEV), the tests shall be carried out under the conditions determined in Annex 14:

- For OVC vehicles, the measurements of emissions of pollutants shall be carried out with the vehicle conditioned according to condition B of the Type I test for OVC hybrid vehicles.
- For NOVC vehicles, the measurements of emissions of pollutants shall be carried out under the same conditions as in the Type I test for NOVC vehicles.

8.2.3.1.1. Three vehicles are selected at random in the series and are tested as described in paragraph 5.3.1. The deterioration factors are used in the same way. The limit values are given in paragraph 5.3.1.4.

8.2.3.1.1.1. In the case of periodically regenerating systems as defined in paragraph 2.20., the results shall be multiplied by the factors K_i obtained by the procedure specified in Annex 13 at the time when type approval was granted.

At the request of the manufacturer, testing may be carried out immediately after a regeneration has been completed.

8.2.3.1.2. If the authority is satisfied with the production standard deviation given by the manufacturer in accordance with paragraph 8.2.1. above, the tests are carried out according to Appendix 1.

If the authority is not satisfied with the production standard deviation given by the manufacturer in accordance with paragraph 8.2.1. above, the tests are carried out according to Appendix 2.

8.2.3.1.3. The production of a series is deemed to conform or not to conform on the basis of a sampling test of the vehicles once a pass decision is reached for all the pollutants or a fail decision is reached for one pollutant, according to the test criteria applied in the appropriate appendix.

When a pass decision has been reached for one pollutant, that decision will not be changed by any additional tests carried out to reach a decision for the other pollutants.

If no pass decision is reached for all the pollutants and no fail decision is reached for one pollutant, a test is carried out on another vehicle (see Figure 2 below).

8.2.3.2. Notwithstanding the requirements of paragraph 3.1.1. of Annex 4, the tests will be carried out on vehicles coming straight off the production line.

8.2.3.2.1. However, at the request of the manufacturer, the tests may be carried out on vehicles which have completed:

- a maximum of 3,000 km for vehicles equipped with a positive-ignition engine, or
- a maximum of 15,000 km for vehicles equipped with a compression-ignition engine.

In both these cases, the running-in procedure will be conducted by the manufacturer, who shall undertake not to make any adjustments to these vehicles.

Figure 2

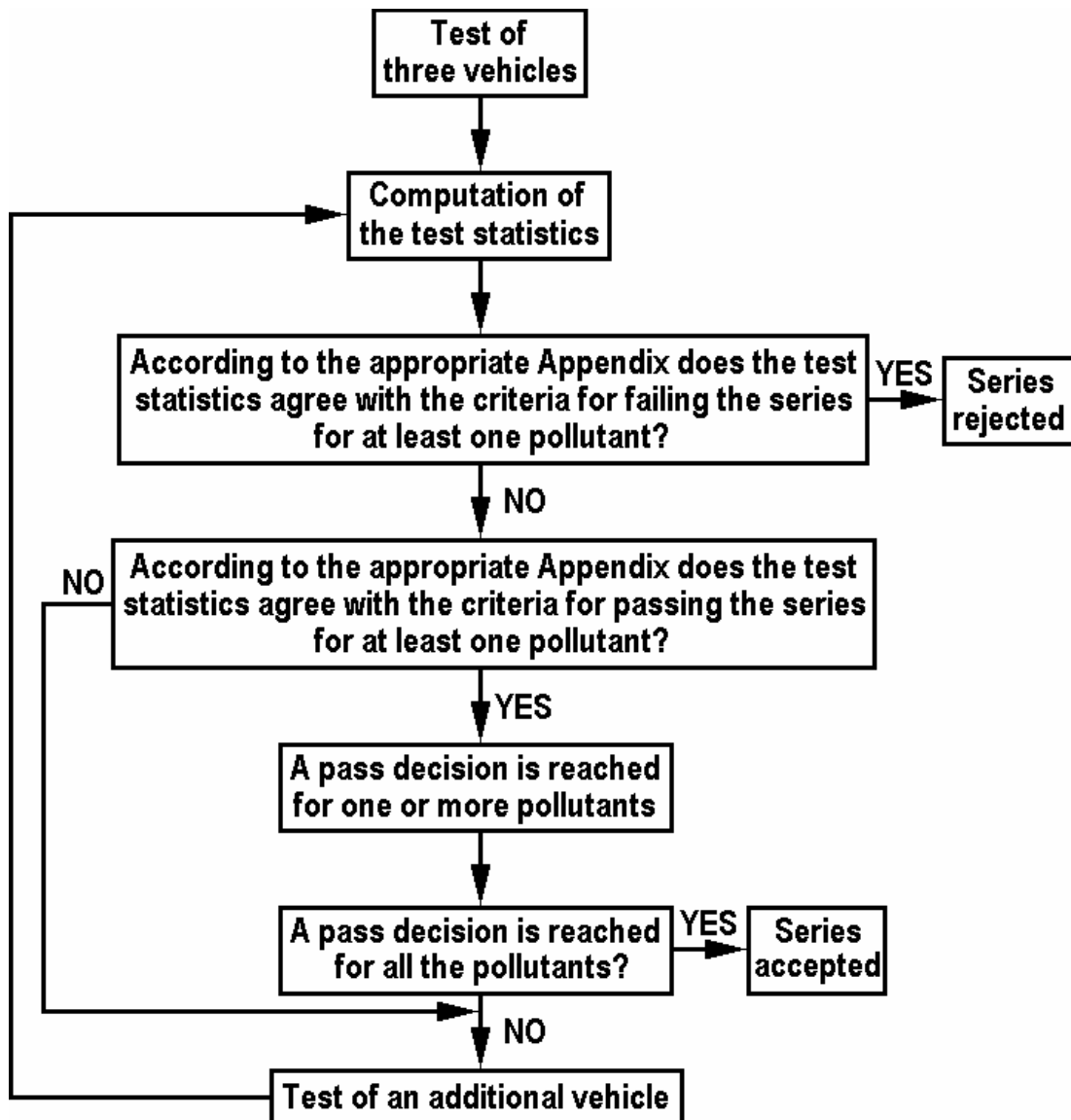

8.2.3.2.2. If the manufacturer wishes to run in the vehicles, ("x" km, where $x \leq 3,000$ km for vehicles equipped with a positive-ignition engine and $x \leq 15,000$ km for vehicles equipped with a compression-ignition engine), the procedure will be as follows:

- (a) the pollutant emissions (Type I) will be measured at zero and at "x" km on the first tested vehicle,
- (b) the evolution coefficient of the emissions between zero and "x" km will be calculated for each of the pollutants:

Emissions "x" km / Emissions zero km

This may be less than 1,

- (c) the other vehicles will not be run in, but their zero km emissions will be multiplied by the evolution coefficient.

In this case, the values to be taken will be:

- (i) the values at 'x' km for the first vehicle,
- (ii) the values at zero km multiplied by the evolution coefficient for the other vehicles.

8.2.3.2.3. All these tests may be conducted with commercial fuel. However, at the manufacturer's request, the reference fuels described in Annex 10 may be used.

- (i) If a Type III test is to be carried out, it shall be conducted on all vehicles selected for the Type I COP test. The conditions laid down in paragraph 5.3.3.2. shall be complied with. For hybrid electric vehicles (HEV), the tests shall be carried out under the conditions determined in Annex 14, paragraph 5.
- (ii) If a Type IV test is to be carried out, it shall be conducted in accordance with paragraph 7. of Annex 7.

8.2.4. When tested in accordance with Annex 7, the average evaporative emissions for all production vehicles of the type approved shall be less than the limit value in paragraph 5.3.4.2.

8.2.5. For routine end-of-production-line testing, the holder of the approval may demonstrate compliance by sampling vehicles which meet the requirements in paragraph 7. of Annex 7.

8.2.6. On-board diagnostics (OBD)

If a verification of the performance of the OBD system is to be carried out, it shall be conducted in accordance with the following:

8.2.6.1. When the approval authority determines that the quality of production seems unsatisfactory a vehicle is randomly taken from the series and subjected to the tests described in Annex 11, Appendix 1.

For hybrid electric vehicles (HEV), the tests shall be carried out under the conditions determined in Annex 14, paragraph 9.

8.2.6.2. The production is deemed to conform if this vehicle meets the requirements of the tests described in Annex 11, Appendix 1.

8.2.6.3. If the vehicle taken from the series does not satisfy the requirements of paragraph 8.2.6.1., a further random sample of four vehicles shall be taken from the series and subjected to the tests described in Annex 11, Appendix 1. The tests may be carried out on vehicles which have been run in for no more than 15,000 km.

8.2.6.4. The production is deemed to conform if at least three vehicles meet the requirements of the tests described in Annex 11, Appendix 1.

8.2.7. On the basis of the audit referred to in paragraph 8.2.1., the administrative department must either:

- decide that the in-service conformity of a vehicle type or a vehicle in-service family is satisfactory and not take any further action;
- decide that the data provided by the manufacturer is insufficient to reach a decision and request additional information or test data from the manufacturer, or
- decide that the in-service conformity of a vehicle type, or vehicle type(s) that is/are part of an in-service family, is unsatisfactory and proceed to have such vehicle type(s) tested in accordance with Appendix 3.

In the case that the manufacturer has been permitted to not carry out an audit for a particular vehicle type in accordance with paragraph 8.2.2., the administrative department may proceed to have such vehicle types tested in accordance with Appendix 3.

8.2.7.1. Where Type I tests are considered necessary to check the conformity of emission control devices with the requirements for their performance while in service, such tests shall be carried out using a test procedure meeting the statistical criteria defined in Appendix 4.

8.2.7.2. The type approval authority, in co-operation with the manufacturer, shall select a sample of vehicles with sufficient mileage whose use under normal

conditions can be reasonably assured. The manufacturer shall be consulted on the choice of the vehicles in the sample and be allowed to attend the confirmatory checks of the vehicles.

8.2.7.3. The manufacturer is authorised, under the supervision of the type approval authority, to carry out checks, even of a destructive nature, on those vehicles with emission levels in excess of the limit values with a view to establishing possible causes of deterioration which cannot be attributed to the manufacturer himself (e.g. use of leaded petrol before the test date). Where the results of the checks confirm such causes, those test results are excluded from the conformity check.

8.2.7.3.1. The test results shall also be excluded from the conformity check of vehicles within the sample:

- (i) that been issued an approval certificate indicating compliance with the emission limits of category A in paragraph 5.3.1.4. of the 05 series of amendments to Regulation provided that those vehicles have been regularly operated on fuel having a sulphur level exceeding 150 mg/kg (petrol fuel) or 350 mg/kg (diesel fuel), or
- (ii) that have been issued with an approval certificate indicating compliance with the emission limits of category B in paragraph 5.3.1.4. of the 05 series of amendments to Regulation provided that those vehicles have been regularly operated on petrol or diesel fuel having a sulphur level exceeding 50 mg/kg.

8.2.7.4. Where the type approval authority is not satisfied with the results of the tests in accordance with the criteria defined in Appendix 4, the remedial measures referred to in Appendix 2 of the 1958 Agreement (E/ECE/324-E/ECE/TRANS/505/Rev.2) are extended to vehicles in service belonging to the same vehicle type which are likely to be affected with the same defects in accordance with paragraph 6. of Appendix 3.

The plan of remedial measures presented by the manufacturer shall be approved by the type approval authority. The manufacturer is responsible for the execution of the remedial plan as approved.

The type approval authority shall notify its decision to all Parties to the Agreement within 30 days. The Parties to the Agreement may require the same plan of remedial measures be applied to all vehicles of the same type registered in their territory.

- 8.2.7.5. If a Party to the Agreement has established that a vehicle type does not conform to the applicable requirements of Appendix 3, it shall notify without delay the Party to the Agreement which granted the original type approval in accordance with the requirements of the Agreement.

Then, subject to the provision of the Agreement, the competent authority of the Party to the Agreement which granted the original type approval shall inform the manufacturer that a vehicle type fails to satisfy the requirements of these provisions and that certain measures are expected of the manufacturer. The manufacturer shall submit to the authority, within two months after this notification, a plan of measures to overcome the defects, the substance of which should correspond to the requirements of paragraphs 6.1. to 6.8. of Appendix 3. The competent authority which granted the original type approval shall, within two months, consult the manufacturer in order to secure agreement on a plan of measures and on carrying out the plan. If the competent authority which granted the original type approval establishes that no agreement can be reached, the relevant procedures to the Agreement shall be initiated.

9. **PENALTIES FOR NON-CONFORMITY OF PRODUCTION**

- 9.1. The approval granted in respect of a vehicle type pursuant to this amendment, may be withdrawn if the requirements laid down in paragraph 8.1. above are not complied with or if the vehicle or vehicles taken fail to pass the tests prescribed in paragraph 8.2. above.

- 9.2. If a Party to the Agreement which applies this Regulation withdraws an approval it has previously granted, it shall forthwith so notify the other Contracting Parties applying this Regulation, by means of a communication form conforming to the model in Annex 2 to this Regulation.

10. **PRODUCTION DEFINITELY DISCONTINUED**

If the holder of the approval completely ceases to manufacture a type of vehicle approved in accordance with this Regulation, he shall so inform the authority which granted the approval. Upon receiving the relevant communication, that authority shall inform thereof the other Parties to the 1958 Agreement applying this Regulation by means of copies of the communication form conforming to the model in Annex 2 to this Regulation.

11. **TRANSITIONAL PROVISIONS**

11.1. General

11.1.1. As from the official date of entry into force of the 05 series of amendments, no Contracting Party applying this Regulation shall refuse to grant approval under this Regulation as amended by the 05 series of amendments.

11.1.2. New type approvals

11.1.2.1. Subject to the provisions of paragraphs 11.1.4., 11.1.5. and 11.1.6., Contracting Parties applying this Regulation shall grant approvals only if the vehicle type to be approved meets the requirements of this Regulation as amended by the 05 series of amendments.

For vehicles of category M or vehicles of category N₁ these requirements shall apply from the date of entry into force of the 05 series of amendments.

Vehicles shall satisfy the limits for the Type I test detailed in either Row A or Row B of the table in paragraph 5.3.1.4. of this Regulation.

11.1.2.2. Subject to the provisions of paragraphs 11.1.4., 11.1.5., 11.1.6. and 11.1.7., Contracting Parties applying this Regulation shall grant approvals only if the vehicle type to be approved meets the requirements of this Regulation as amended by the 05 series of amendments.

For vehicles of category M having a maximum mass less than or equal to 2,500 kg or vehicles of category N₁ (Class I) these requirements shall apply from 1 January 2005.

For vehicles of category M having a maximum mass greater than 2,500 kg or vehicles of category N₁ (Classes II or III) these requirements shall apply from 1 January 2006.

Vehicles shall satisfy the limits for the Type I test detailed in Row B of the table in paragraph 5.3.1.4. of this Regulation.

11.1.3. Limit of validity of existing type approvals

11.1.3.1. Subject to the provisions of paragraphs 11.1.4., 11.1.5. and 11.1.6., approvals granted to this Regulation, as amended by the 04 series of amendments, shall cease to be valid from the date of entry into force of the 05 series of

amendments for vehicles of category M having a maximum mass less than or equal to 2,500 kg or vehicles of category N₁ (Class I) and on 1 January 2002 for vehicles of category M having a maximum mass greater than 2,500 kg or vehicles of category N₁ (Classes II or III), unless the Contracting Party which granted the approval notifies the other Contracting Parties applying this Regulation that the vehicle type approved meets the requirements of this Regulation as required by paragraph 11.1.2.1. above.

11.1.3.2. Subject to the provisions of paragraphs 11.1.4., 11.1.5., 11.1.6. and 11.1.7., approvals granted to this Regulation, as amended by the 05 series of amendments and to the limit values of Row A of the table in paragraph 5.3.1.4. of this Regulation, shall cease to be valid on 1 January 2006 for vehicles of category M having a maximum mass less than or equal to 2,500 kg or vehicles of category N₁ (Class I) and on 1 January 2007 for vehicles of category M having a maximum mass greater than 2,500 kg or vehicles of category N₁ (Classes II or III), unless the Contracting Party which granted the approval notifies the other Contracting Parties applying this Regulation that the vehicle type approved meets the requirements of this Regulation as required by paragraph 11.1.2.2. above.

11.1.4. Special provisions

11.1.4.1. Until 1 January 2003, vehicles of category M₁, fitted with compression-ignition engines and having a maximum mass greater than 2,000 kg, which:

- (i) are designed to carry more than six occupants (including the driver), or
- (ii) are off-road vehicles as defined in Annex 7 of the Consolidated Resolution on the Construction of Vehicles (R.E.3) 3/

shall be considered, for the purposes of paragraphs 11.1.3.1. and 11.1.3.2. as vehicles in category N₁.

11.1.4.2. In the case of vehicles equipped with direct-injection compression-ignition engines and designed to carry more than six occupants (including the driver), approvals granted in accordance with the provision of paragraph 5.3.1.4.1. of this Regulation, as amended by the 04 series of amendments, shall continue to be valid until 1 January 2002.

11.1.4.3. Type approval and conformity of production verification provisions, as specified in this Regulation as amended by the 04 series of amendments,

3/ document TRANS/WP.29/78/Rev.1/Amend.2.

remain applicable until the dates referred to in paragraphs 11.1.2.1. and 11.1.3.1.

11.1.4.4. As from 1 January 2002, the Type VI test defined in Annex 8 is applicable to new types of vehicle of category M₁ and of category N₁ Class 1 and which are equipped with a positive-ignition engine. This requirement shall not apply to such vehicles equipped to carry more than six occupants (including the driver) or to vehicles whose maximum mass exceeds 2,500 kg.

11.1.5. On-board diagnostic (OBD) system

11.1.5.1. Vehicles equipped with positive ignition engines

11.1.5.1.1. Vehicles of category M₁ and N₁ fuelled with petrol shall be equipped with on-board diagnostic systems, as specified in paragraph 3.1. to Annex 11 of this Regulation, on the dates shown in paragraph 11.1.2.

11.1.5.1.2. Vehicles of category M₁, other than vehicles whose maximum mass exceeds 2,500 kg, and N₁ class I, running permanently or part-time on either LPG or NG fuel shall be equipped with on-board diagnostic systems from 1 October 2004 for new types and from 1 July 2005 for all types.

Vehicles of category M₁ whose maximum mass exceeds 2,500 kg and N₁ classes II and III, running permanently or part-time on either LPG or NG fuel shall be equipped with on-board diagnostic systems from 1 January 2006 for new types and from 1 January 2007 for all types.

11.1.5.2. Vehicles equipped with compression-ignition engines

11.1.5.2.1. Vehicles of category M₁, other than vehicles designed to carry more than six occupants (including the driver) or vehicles whose maximum mass exceeds 2,500 kg, shall be equipped with on-board diagnostic systems from 1 October 2004 for new types and from 1 July 2005 for all types.

11.1.5.2.2. Vehicles of category M₁ not covered by paragraph 11.1.5.2.1., except vehicles whose maximum mass exceeds 2,500 kg, and vehicles of category N₁ class I, shall be equipped with on-board diagnostic systems from 1 January 2005 for new types and from 1 January 2006 for all types.

11.1.5.2.3. Vehicles of category N₁, classes II and III, and vehicles of category M₁ whose maximum mass exceeds 2,500 kg, shall be equipped with on-board diagnostic systems from 1 January 2006 for new types and from 1 January 2007 for all types.

- 11.1.5.2.4. Where compression-ignition engined vehicles entering into service prior to the dates given in the paragraphs above are fitted with on-board diagnostic systems, the provisions of paragraphs 6.5.3. to 6.5.3.6. of Annex 11, Appendix 1, are applicable.
- 11.1.5.3. Vehicles of other categories or vehicles of category M₁ or N₁ not covered by the above may be equipped with on-board diagnostic systems. In this case, they shall comply with the OBD provisions laid down in paragraphs 6.5.3. to 6.5.3.6. of Annex 11, Appendix 1.
- 11.1.6. Approvals to the Regulation as amended by the 04 series of amendments
- 11.1.6.1. By exception to the requirements of paragraphs 11.1.2. and 11.1.3., Contracting Parties may continue to approve vehicles and may continue to recognise the validity of existing approvals that indicate compliance with:
- (i) the requirements of paragraph 5.3.1.4.1. of the 04 series of amendments to this Regulation provided that the vehicles are intended for export to, or for first use in, countries where the use of unleaded petrol is not widely available, and
 - (ii) the requirements of paragraph 5.3.1.4.2 of the 04 series of amendments to this Regulation provided that the vehicles are intended for export to, or for first use in, countries where unleaded petrol having a maximum sulphur level of 50 mg/kg or less is not widely available, and
 - (iii) the requirements of paragraph 5.3.1.4.3. of the 04 series of amendments to this Regulation provided that the vehicles are intended for export to, or for first use in, countries where diesel fuel having a maximum sulphur level of 350 mg/kg or less is not widely available.
- 11.1.6.2. By way of derogation to the obligations of Contracting Parties to this Regulation, approvals granted to this Regulation, as amended by the 04 series of amendments, shall cease to be valid in the European Community from:
- (i) 1 January 2001 for vehicles of category M having a maximum mass less than or equal to 2,500 kg or vehicles of category N₁ (Class I), and on
 - (ii) 1 January 2002 for vehicles of category M having a maximum mass greater than 2500 kg or vehicles of category N₁ (Classes II or III),
- unless the Contracting Party which granted the approval notifies the other Contracting Parties applying this Regulation that the vehicle type approved

meets the requirements of this Regulation as required by paragraph 11.1.2.1. above.

11.1.7. Approvals to Regulation as amended by 05 series of amendments

11.1.7.1. By exception to the requirements of paragraph 11.1.2.2. and 11.1.3.2. Contracting Parties may continue to approve vehicles and may continue to recognize the validity of approvals granted to vehicles to the requirements of paragraph 5.3.1.4. (concerning category A emissions) of the 05 series of amendments to this Regulation provided that the vehicles are intended for export to, or for first use in, countries where unleaded petrol or diesel fuels having maximum sulphur levels of 50 mg/kg or less are not widely available.

11.1.7.2. By way of derogation to the obligations of Contracting Parties to this Regulation, approvals granted indicating compliance with the emission limits of category A in paragraph 5.3.1.4. of the 05 series of amendments to this Regulation, shall cease to be valid in the European Community from:

- (i) 1 January 2006 for vehicles of category M having a maximum mass less than or equal to 2,500 kg or vehicles of category N₁ (Class I), and on
- (ii) 1 January 2007 for vehicles of category M having a maximum mass greater than 2,500 kg or vehicles of category N₁ (Class II or III),

unless the Contracting Party which has granted the approval notifies other Contracting Parties applying this Regulation that the vehicle type approved meets the requirements of this Regulation as required by paragraph 11.1.2.2. above.

12. **NAMES AND ADDRESSES OF TECHNICAL SERVICES RESPONSIBLE FOR CONDUCTING APPROVAL TESTS, AND OF ADMINISTRATIVE DEPARTMENTS**

The Parties to the 1958 Agreement which apply this Regulation shall communicate to the United Nations Secretariat the names and addresses of the technical services responsible for conducting approval tests and of the administrative departments which grant approval and to which forms certifying approval or extension or refusal or withdrawal of approval, issued in other countries, are to be sent.

Appendix 1

**PROCEDURE FOR VERIFYING THE CONFORMITY OF PRODUCTION REQUIREMENTS
IF THE PRODUCTION STANDARD DEVIATION GIVEN BY THE MANUFACTURER IS
SATISFACTORY**

1. This Appendix describes the procedure to be used to verify the production conformity for the Type I test when the manufacturer's production standard deviation is satisfactory.
2. With a minimum sample size of 3, the sampling procedure is set so that the probability of a lot passing a test with 40 per cent of the production defective is 0.95 (producer's risk = 5 per cent) while the probability of a lot being accepted with 65 per cent of the production defective is 0.1 (consumer's risk = 10 per cent).
3. For each of the pollutants given in paragraph 5.3.1.4. of this Regulation, the following procedure is used (see Figure 2 of this Regulation).

Taking:

L = the natural logarithm of the limit value for the pollutant,

x_i = the natural logarithm of the measurement for the i-th vehicle of the sample,

s = an estimate of the production standard deviation (after taking the natural logarithm of the measurements),

n = the current sample number.

4. Compute for the sample the test statistic quantifying the sum of the standard deviations from the limit and defined as:

$$\frac{1}{s} \sum_{i=1}^n (L - x_i)$$

5. Then :

- 5.1. If the test statistic is greater than the pass decision number for the sample size given in Table (1/1 below), the pollutant is passed.

- 5.2. If the test statistic is less than the fail decision number for the sample size given in Table (1/1 below), the pollutant is failed; otherwise, an additional vehicle is tested and the calculation reapplied to the sample with a sample size one unit greater.

Table 1/1

Cumulative number of tested vehicles (current sample size)	Pass decision threshold	Fail decision threshold
3	3.327	-4.724
4	3.261	-4.79
5	3.195	-4.856
6	3.129	-4.922
7	3.063	-4.988
8	2.997	-5.054
9	2.931	-5.12
10	2.865	-5.185
11	2.799	-5.251
12	2.733	-5.317
13	2.667	-5.383
14	2.601	-5.449
15	2.535	-5.515
16	2.469	-5.581
17	2.403	-5.647
18	2.337	-5.713
19	2.271	-5.779
20	2.205	-5.845
21	2.139	-5.911
22	2.073	-5.977
23	2.007	-6.043
24	1.941	-6.109
25	1.875	-6.175
26	1.809	-6.241
27	1.743	-6.307
28	1.677	-6.373

Regulation No.83
Page 51
Appendix 1

29	1.611	-6.439
30	1.545	-6.505
31	1.479	-6.571
32	-2.112	-2.112

Appendix 2

PROCEDURE FOR VERIFYING THE CONFORMITY OF PRODUCTION REQUIREMENTS IF THE PRODUCTION STANDARD DEVIATION GIVEN BY THE MANUFACTURER IS EITHER NOT SATISFACTORY OR NOT AVAILABLE

1. This Appendix describes the procedure to be used to verify the production conformity requirements for the Type I test when the manufacturer's evidence of production standard deviation is either not satisfactory or not available.
2. With a minimum sample size of 3, the sampling procedure is set so that the probability of a lot passing a test with 40 per cent of the production defective is 0.95 (producer's risk = 5 per cent) while the probability of a lot being accepted with 65 per cent of the production defective is 0.1 (consumer's risk = 10 per cent).
3. The measurements of the pollutants given in paragraph 5.3.1.4. of this Regulation are considered to be log normally distributed and shall first be transformed by taking their natural logarithms. Let m_0 and m denote the minimum and maximum sample sizes respectively ($m_0 = 3$ and $m = 32$) and let n denote the current sample number.
4. If the natural logarithms of the measurements in the series are x_1, x_2, \dots, x_i and L is the natural logarithm of the limit value for the pollutant, then define:

$$d_i = x_i - L$$

$$\bar{d}_n = \frac{1}{n} \sum_{i=1}^n d_i$$

and

$$V_n^2 = \frac{1}{n} \sum_{i=1}^n (d_i - \bar{d}_n)^2$$

5. Table 1/2 shows values of the pass (A_n) and fail (B_n) decision numbers against current sample number. The test statistic is the ratio \bar{d}_n/V_n and shall be used to determine whether the series has passed or failed as follows:

For $m_0 \leq n \leq m$:

(i) Pass the series if $\frac{\bar{d}_n}{V_n} \leq A_n$

(ii) Fail the series if $\frac{\bar{d}_n}{V_n} \geq B_n$

(iii) Take another measurement if $A_n < \frac{\bar{d}_n}{V_n} < B_n$

Table 1/2

Minimum sample size = 3

Sample size (n)	Pass decision threshold (A _n)	Fail decision threshold (B _n)
3	-0.80381	16.64743
4	-0.76339	7.68627
5	-0.72982	4.67136
6	-0.69962	3.25573
7	-0.67129	2.45431
8	-0.64406	1.94369
9	-0.61750	1.59105
10	-0.59135	1.33295
11	-0.56542	1.13566
12	-0.53960	0.97970
13	-0.51379	0.85307
14	-0.48791	0.74801
15	-0.46191	0.65928
16	-0.43573	0.58321
17	-0.40933	0.51718
18	-0.38266	0.45922
19	-0.35570	0.40788
20	-0.32840	0.36203
21	-0.30072	0.32078
22	-0.27263	0.28343
23	-0.24410	0.24943
24	-0.21509	0.21831
25	-0.18557	0.18970
26	-0.15550	0.16328
27	-0.12483	0.13880

28	-0.09354	0.11603
29	-0.06159	0.09480
30	-0.02892	0.07493
31	0.00449	0.05629
32	0.03876	0.03876

6. Remarks

The following recursive formulae are useful for computing successive values of the test statistic:

$$\bar{d}_n = \left(1 - \frac{1}{n}\right) \bar{d}_{n-1} + \frac{1}{n} d_n$$

$$V_n^2 = \left(1 - \frac{1}{n}\right) V_{n-1}^2 + \left[\frac{\bar{d}_n - d_n}{n-1}\right]^2$$

$$(n = 2, 3, \dots ; \quad \bar{d}_1 = d_1; \quad V_1 = 0 \quad)$$

Appendix 3

IN-SERVICE CONFORMITY CHECK

1. INTRODUCTION

This Appendix sets out the criteria referred to in paragraph 8.2.7. of this Regulation regarding the selection of vehicles for testing and the procedures for the in-service conformity control.

2. SELECTION CRITERIA

The criteria for acceptance of a selected vehicle are defined in paragraphs 2.1. to 2.8. of this Appendix. Information is collected by vehicle examination and an interview with the owner/driver.

- 2.1. The vehicle shall belong to a vehicle type that is type approved under this Regulation and covered by a certificate of conformity in accordance with the 1958 Agreement. It shall be registered and used in a country of the Contracting Parties.
- 2.2. The vehicle shall have been in service for at least 15,000 km or 6 months, whichever is the later, and for no more than 80,000 km or 5 years, whichever is the sooner.
- 2.3. There shall be a maintenance record to show that the vehicle has been properly maintained, e.g. has been serviced in accordance with the manufacturer's recommendations.
- 2.4. The vehicle shall exhibit no indications of abuse (e.g. racing, overloading, misfuelling, or other misuse), or other factors (e.g. tampering) that could affect emission performance. In the case of vehicles fitted with an OBD system, the fault code and mileage information stored in the computer is taken into account. A vehicle shall not be selected for testing if the information stored in the computer shows that the vehicle has operated after a fault code was stored and a relatively prompt repair was not carried out.
- 2.5. There shall have been no unauthorised major repair to the engine or major repair of the vehicle.
- 2.6. The lead content and sulphur content of a fuel sample from the vehicle tank shall meet applicable standards and there shall be no evidence of misfuelling. Checks may be done in the exhaust, etc.
- 2.7. There shall be no indication of any problem that might jeopardise the safety of laboratory personnel.

2.8. All anti-pollution system components on the vehicle shall be in conformity with the applicable type approval.

3. DIAGNOSIS AND MAINTENANCE

Diagnosis and any normal maintenance necessary shall be performed on vehicles accepted for testing, prior to measuring exhaust emissions, in accordance with the procedure laid down in paragraphs 3.1. to 3.7. below.

3.1. The following checks shall be carried out: checks on air filter, all drive belts, all fluid levels, radiator cap, all vacuum hoses and electrical wiring related to the anti-pollution system for integrity; checks on ignition, fuel metering and anti-pollution device components for maladjustments and/or tampering. All discrepancies shall be recorded.

3.2. The OBD system shall be checked for proper functioning. Any malfunction indications in the OBD memory shall be recorded and the requisite repairs shall be carried out. If the OBD malfunction indicator registers a malfunction during a preconditioning cycle, the fault may be identified and repaired. The test may be re-run and the results of that repaired vehicle used.

3.3. The ignition system shall be checked and defective components replaced, for example spark plugs, cables, etc.

3.4. The compression shall be checked. If the result is unsatisfactory the vehicle is rejected.

3.5. The engine parameters shall be checked to the manufacturer's specifications and adjusted if necessary.

3.6. If the vehicle is within 800 km of a scheduled maintenance service, that service shall be performed according to the manufacturer's instructions. Regardless of odometer reading, the oil and air filter may be changed at the request of the manufacturer.

3.7. Upon acceptance of the vehicle, the fuel shall be replaced with appropriate emission test reference fuel, unless the manufacturer accepts the use of market fuel.

3.8. In the case of vehicles equipped with periodically regenerating systems as defined in paragraph 2.20., it shall be established that the vehicle is not approaching a regeneration period. (The manufacturer must be given the opportunity to confirm this).

3.8.1. If this is the case, the vehicle must be driven until the end of the regeneration. If a regeneration occurs during emissions measurement, then a further test must be carried out to ensure that regeneration has been completed. A complete new test shall then be performed, and the first and second test results not taken into account.

- 3.8.2. As an alternative to paragraph 3.8.1., if the vehicle is approaching a regeneration, the manufacturer may request that a specific conditioning cycle is used to ensure that regeneration (e.g. this may involve high speed, high load driving).

The manufacturer may request that testing may be carried out immediately after regeneration or after the conditioning cycle specified by the manufacturer and normal test preconditioning.

4. IN-SERVICE TESTING

- 4.1. When a check on vehicles is deemed necessary, emission tests in accordance with Annex 4 to this Regulation are performed on pre-conditioned vehicles selected in accordance with the requirements of paragraphs 2. and 3. of this Appendix.
- 4.2. Vehicles equipped with an OBD system may be checked for proper in-service functionality of the malfunction indication, etc., in relation to levels of emissions (e.g. the malfunction indication limits defined in Annex 11 to this Regulation) for the type approved specifications.
- 4.3. The OBD system may be checked, for example, for levels of emissions above the applicable limit values with no malfunction indication, systematic erroneous activation of the malfunction indication and identified faulty or deteriorated components in the OBD system.
- 4.4. If a component or system operates in a manner not covered by the particulars in the type approval certificate and/or information package for such vehicle types and such deviation has not been authorised under the 1958 Agreement, with no malfunction indication by the OBD, the component or system shall not be replaced prior to emission testing, unless it is determined that the component or system has been tampered with or abused in such a manner that the OBD does not detect the resulting malfunction.

5. EVALUATION OF RESULTS

- 5.1. The test results are submitted to the evaluation procedure in accordance with Appendix 4.
- 5.2. Test results shall not be multiplied by deterioration factors.
- 5.3. In the case of periodically regenerating systems as defined in paragraph 2.20., the results shall be multiplied by the factors K_i obtained at the time when type approval was granted.

6. PLAN OF REMEDIAL MEASURES

- 6.1. When more than one vehicle is found to be an outlying emitter that either,
- meets the conditions of paragraph 3.2.3. of Appendix 4 and where both the administrative department and the manufacturer agree that the excess emission is due to the same cause, or
 - meets the conditions of paragraph 3.2.4. of Appendix 4 where the administrative department has determined that the excess emission is due to the same cause,

the administrative department must request the manufacturer to submit a plan of remedial measures to remedy the non-compliance.

- 6.2. The plan of remedial measures shall be filed with the type approval authority not later than 60 working days from the date of the notification referred to in paragraph 6.1. above. The type approval authority shall within 30 working days declare its approval or disapproval of the plan of remedial measures. However, where the manufacturer can demonstrate, to the satisfaction of the competent type approval authority, that further time is required to investigate the non-compliance in order to submit a plan of remedial measures, an extension is granted.
- 6.3. The remedial measures shall apply to all vehicles likely to be affected by the same defect. The need to amend the type approval documents shall be assessed.
- 6.4. The manufacturer shall provide a copy of all communications related to the plan of remedial measures, and shall also maintain a record of the recall campaign, and supply regular status reports to the type approval authority.
- 6.5. The plan of remedial measures shall include the requirements specified in paragraphs 6.5.1. to 6.5.11. The manufacturer shall assign a unique identifying name or number to the plan of remedial measures.
- 6.5.1. A description of each vehicle type included in the plan of remedial measures.
- 6.5.2. A description of the specific modifications, alterations, repairs, corrections, adjustments, or other changes to be made to bring the vehicles into conformity including a brief summary of the data and technical studies which support the manufacturer's decision as to the particular measures to be taken to correct the non-conformity.
- 6.5.3. A description of the method by which the manufacturer informs the vehicle owners.

- 6.5.4. A description of the proper maintenance or use, if any, which the manufacturer stipulates as a condition of eligibility for repair under the plan of remedial measures, and an explanation of the manufacturer's reasons for imposing any such condition. No maintenance or use conditions may be imposed unless it is demonstrably related to the non-conformity and the remedial measures.
- 6.5.5. A description of the procedure to be followed by vehicle owners to obtain correction of the non-conformity. This shall include a date after which the remedial measures may be taken, the estimated time for the workshop to perform the repairs and where they can be done. The repair shall be done expeditiously, within a reasonable time after delivery of the vehicle.
- 6.5.6. A copy of the information transmitted to the vehicle owner.
- 6.5.7. A brief description of the system which the manufacturer uses to assure an adequate supply of component or systems for fulfilling the remedial action. It shall be indicated when there will be an adequate supply of components or systems to initiate the campaign.
- 6.5.8. A copy of all instructions to be sent to those persons who are to perform the repair.
- 6.5.9. A description of the impact of the proposed remedial measures on the emissions, fuel consumption, derivability, and safety of each vehicle type, covered by the plan of remedial measures with data, technical studies, etc. which support these conclusions.
- 6.5.10. Any other information, reports or data the type approval authority may reasonably determine is necessary to evaluate the plan of remedial measures.
- 6.5.11. Where the plan of remedial measures includes a recall, a description of the method for recording the repair shall be submitted to the type approval authority. If a label is used, an example of it shall be submitted.
- 6.6. The manufacturer may be required to conduct reasonably designed and necessary tests on components and vehicles incorporating a proposed change, repair, or modification to demonstrate the effectiveness of the change, repair, or modification.
- 6.7. The manufacturer is responsible for keeping a record of every vehicle recalled and repaired and the workshop which performed the repair. The type approval authority shall have access to the record on request for a period of five years from the implementation of the plan of remedial measures.
- 6.8. The repair and/or modification or addition of new equipment shall be recorded in a certificate supplied by the manufacturer to the vehicle owner.

Appendix 4

STATISTICAL PROCEDURE FOR IN-SERVICE CONFORMITY TESTING

1. This Appendix describes the procedure to be used to verify the in-service conformity requirements for the Type I test.
2. Two different procedures are to be followed:
 - (i) One dealing with vehicles identified in the sample, due to an emission-related defect, causing outliers in the results (paragraph 3. below).
 - (ii) The other deals with the total sample (paragraph 4. below).
3. PROCEDURE TO BE FOLLOWED WITH OUTLYING EMITTERS IN THE SAMPLE 1/
 - 3.1. With a minimum sample size of three and a maximum sample size as determined by the procedure of paragraph 4., a vehicle is taken at random from the sample and the emissions of the regulated pollutants are measured to determine if it is an outlying emitter.
 - 3.2. A vehicle is said to be an outlying emitter when the conditions given in either paragraph 3.2.1. or paragraph 3.2.2. are met.
 - 3.2.1. In the case of a vehicle that has been type-approved according to the limit values given in row A of the table in paragraph 5.3.1.4. of this Regulation, an outlying emitter is a vehicle where the applicable limit value for any regulated pollutant is exceeded by a factor of 1.2.
 - 3.2.2. In the case of a vehicle that has been type-approved according to the limit values given in row B of the table in paragraph 5.3.1.4. of this Regulation, an outlying emitter is a vehicle where the applicable limit value for any regulated pollutant is exceeded by a factor of 1.5.
 - 3.2.3. In the specific case of a vehicle with a measured emission for any regulated pollutant within the ‘intermediate zone’ 2/.

1/ On the basis of actual in-service data to be supplied before 31 December 2003, the requirements of this paragraph may be reviewed and consider (a) whether the definition of outlying emitter needs to be revised with respect to vehicles that have been type-approved according to the limit values given in row B of the table in paragraph 5.3.1.4. of this Regulation, (b) whether the procedure for identifying outlying emitters should be amended and (c) whether the procedures for in-service conformity testing should be replaced at an appropriate time by a new statistical procedure. If appropriate the necessary amendments will be proposed.

2/ For any vehicle, the “intermediate zone” is determined as follows. The vehicle shall meet the conditions given in either paragraph 3.2.1. or paragraph 3.2.2. and, in addition, the measured value for the same regulated pollutant shall be below a level that is determined from the product of the limit value for the same regulated pollutant given in row A of the table in paragraph 5.3.1.4. of this Regulation multiplied by a factor of 2.5.

- 3.2.3.1. If the vehicle meets the conditions of this paragraph, the cause of the excess emission must be determined and another vehicle is then taken at random from the sample.
- 3.2.3.2. Where more than one vehicle meets the condition of this paragraph, the administrative department and the manufacturer must determine if the excess emission from both vehicles is due to the same cause or not.
- 3.2.3.2.1. If the administrative department and the manufacturer both agree that the excess emission is due to the same cause, the sample is regarded as having failed and the plan of remedial measures outlined in paragraph 6. of Appendix 3 applies.
- 3.2.3.2.2. If the administrative department and the manufacturer cannot agree on either the cause of the excess emission from an individual vehicle, or whether the causes for more than one vehicle are the same, another vehicle is taken at random from the sample, unless the maximum sample size has already been reached.
- 3.2.3.3. When only one vehicle meeting the conditions of this paragraph has been found, or when more than one vehicle has been found and the administrative department and the manufacturer agree it is due to different causes, another vehicle is taken at random from the sample, unless the maximum sample size has already been reached.
- 3.2.3.4. If the maximum sample size is reached, and not more than one vehicle meeting the requirements of this paragraph has been found where the excess emission is due to the same cause, the sample is regarded as having passed with regard to the requirements of paragraph 3 of this Appendix.
- 3.2.3.5. If, at any time, the initial sample has been exhausted, another vehicle is added to the initial sample and that vehicle is taken.
- 3.2.3.6. Whenever another vehicle is taken from the sample, the statistical procedure of paragraph 4. of this Appendix is applied to the increased sample.
- 3.2.4. In the specific case of a vehicle with a measured emission for any regulated pollutant within the ‘failure zone’ 3/.
- 3.2.4.1. If the vehicle meets the conditions of this paragraph, the administrative department shall determine the cause of the excess emission and another vehicle is then taken at random from the sample.

3/ For any vehicle, the “failure zone” is determined as follows. The measured value for any regulated pollutant exceeds a level that is determined from the product of the limit value for the same regulated pollutant given in row A of the table in paragraph 5.3.1.4. of this Regulation multiplied by a factor of 2.5.

- 3.2.4.2. Where more than one vehicle meets the condition of this paragraph, and the administrative department determines that the excess emission is due to the same cause, the manufacturer shall be informed that the sample is regarded as having failed, together with the reasons for that decision, and the plan of remedial measures outlined in paragraph 6. of Appendix 3 applies.
- 3.2.4.3. When only one vehicle meeting the conditions of this paragraph has been found, or when more than one vehicle has been found and the administrative department has determined that it is due to different causes, another vehicle is taken at random from the sample, unless the maximum sample size has already been reached.
- 3.2.4.4. If the maximum sample size is reached and not more than one vehicle meeting the requirements of this paragraph has been found where the excess emission is due to the same cause, the sample is regarded as having passed with regard to the requirements of paragraph 3. of this Appendix.
- 3.2.4.5. If, at any time, the initial sample has been exhausted, another vehicle is added to the initial sample and that vehicle is taken.
- 3.2.4.6. Whenever another vehicle is taken from the sample, the statistical procedure of paragraph 4. of this Appendix is applied to the increased sample.
- 3.2.5. Whenever a vehicle is not found to be an outlying emitter, another vehicle is taken at random from the sample.
- 3.3. When an outlying emitter is found, the cause of the excess emission shall be determined.
- 3.4. When more than one vehicle is found to be an outlying emitter, due to the same cause, the sample is regarded as having failed.
- 3.5. When only one outlying emitter has been found, or when more than one outlying emitter is found, but due to different causes, the sample is increased by one vehicle, unless the maximum sample size has already been reached.
 - 3.5.1. When in the increased sample more than one vehicle is found to be an outlying emitter, due to the same cause, the sample is regarded as having failed.
 - 3.5.2. When in the maximum sample size not more than one outlying emitter is found, where the excess emission is due to the same cause, the sample is regarded as having passed with regard to the requirements of paragraph 3. of this Appendix.
- 3.6. Whenever a sample is increased due to the requirements of paragraph 3.5., the statistical procedure of paragraph 4. below is applied to the increased sample.

4. PROCEDURE TO BE FOLLOWED WITHOUT SEPARATE EVALUATION OF OUTLYING EMITTERS IN THE SAMPLE
- 4.1. With a minimum sample size of three vehicles, the sampling procedure is set so that the probability of a batch passing a test with 40 per cent of the production defective is 0.95 (producer's risk = 5 per cent) while the probability of a batch being accepted with 75 per cent of the production defective is 0.15 (consumer's risk = 15 per cent).
- 4.2. For each of the pollutants given in the table of paragraph 5.3.1.4. of this Regulation, the following procedure is used (see Figure 4/2 below).
- where:
- L = the limit value for the pollutant,
- x_i = the value of the measurement for the i-th vehicle of the sample,
- n = the current sample number.
- 4.3. The test statistic quantifying the number of non-conforming vehicles, i.e. $x_i > L$, is computed for the sample.
- 4.4. Then:
- (i) If the test statistic does not exceed the pass decision number for the sample size given in the following table, a pass decision is reached for the pollutant,
 - (ii) If the test statistic equals or exceeds the fail decision number for the sample size given in the following table, a fail decision is reached for the pollutant,
 - (iii) Otherwise, an additional vehicle is tested and the procedure is applied to the sample with one extra unit.
- In the following table the pass and fail decision numbers are computed in accordance with the International Standard ISO 8422:1991.
5. A sample is regarded as having passed the test when it has passed both the requirements of paragraphs 3. and 4. of this Appendix.

Figure 4/1

In-service conformity checking – audit procedure

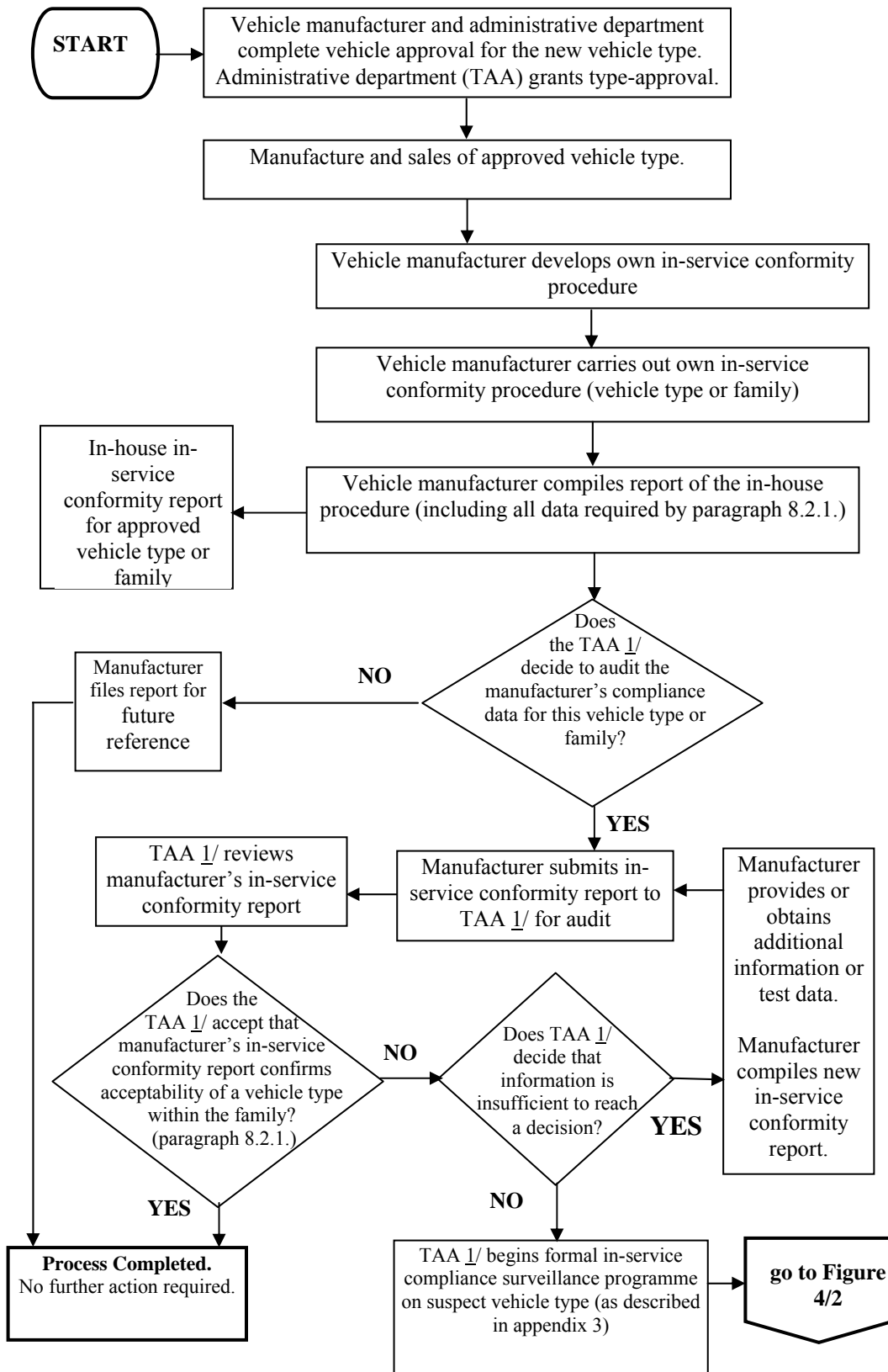

1/ In this case, TAA means the administrative department that granted the type-approval.

Table 4/1

TABLE FOR ACCEPTANCE/REJECTION SAMPLING PLAN BY ATTRIBUTES

Cumulative sample size (n)	Pass Decision number	Fail decision number
3	0	-
4	1	-
5	1	5
6	2	6
7	2	6
8	3	7
9	4	8
10	4	8
11	5	9
12	5	9
13	6	10
14	6	11
15	7	11
16	8	12
17	8	12
18	9	13
19	9	13
20	11	12

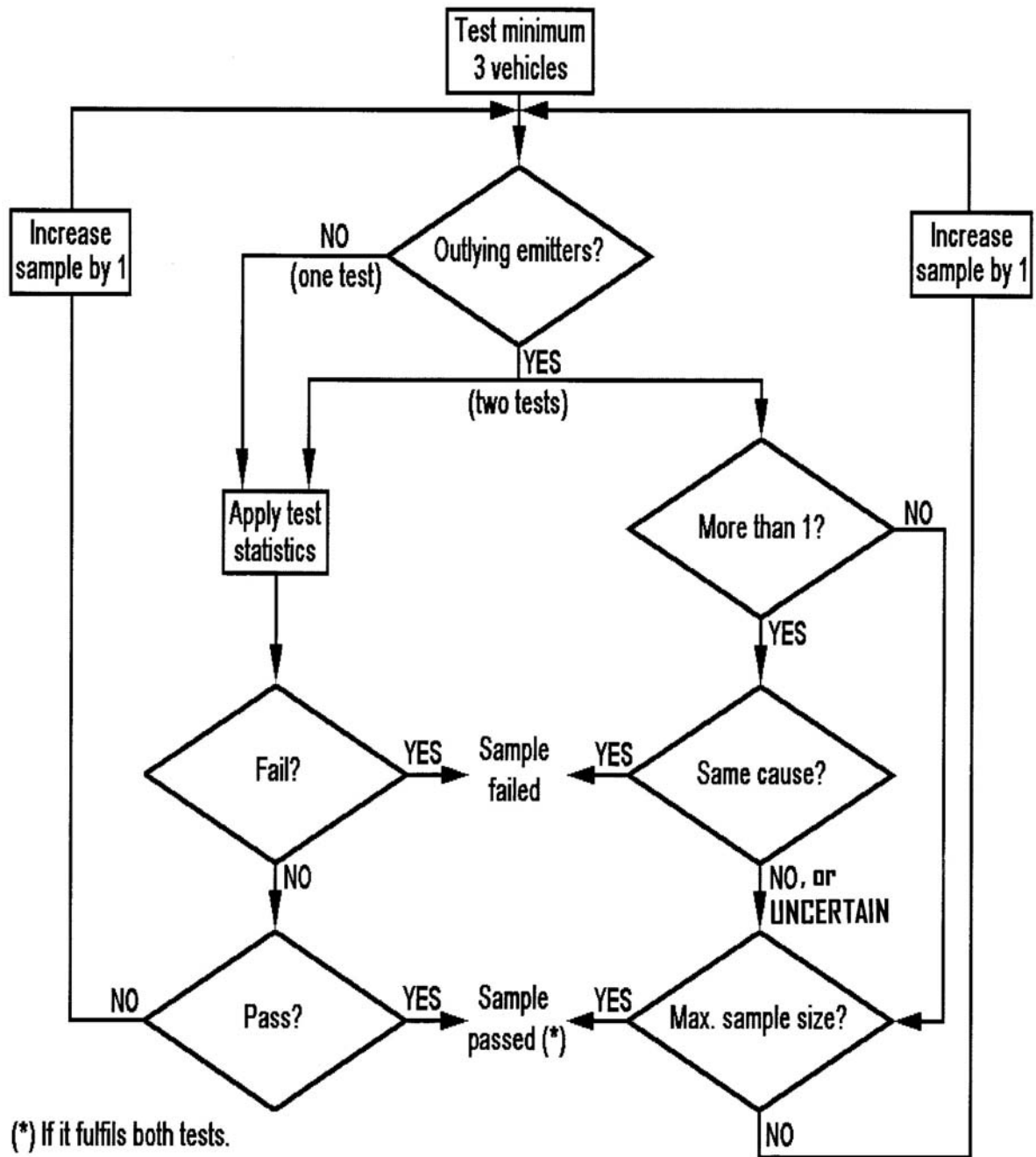

Figure 4/2

In-service conformity testing – selection and test of vehicles

Annex 1

**ENGINE AND VEHICLE CHARACTERISTICS AND INFORMATION CONCERNING
THE CONDUCT OF TESTS**

The following information, when applicable, shall be supplied in triplicate.

If there are drawings, they shall be to an appropriate scale and show sufficient detail; they shall be presented in A4 format or folded to that format. In the case of microprocessor-controlled functions, appropriate operating information shall be supplied.

1. GENERAL
 - 1.1. Make (name of undertaking):
 - 1.2. Type and commercial description (mention any variants):
 - 1.3. Means of identification of type, if marked on the vehicle:.....
 - 1.3.1. Location of that mark:
 - 1.4. Category of vehicle:
 - 1.5. Name and address of manufacturer:
 -
 - 1.6. Name and address of manufacturer's authorized representative where appropriate:.....
2. GENERAL CONSTRUCTION CHARACTERISTICS OF THE VEHICLE
 - 2.1. Photographs and/or drawings of a representative vehicle:.....
 - 2.2. Powered axles (number, position, interconnection):
3. MASSES (kilograms) (refer to drawing where applicable)
 - 3.1. Mass of the vehicle with bodywork in running order, or mass of the chassis with cab if the manufacturer does not fit the bodywork (including coolant, oils, fuel, tools, spare wheel and driver):
.....
 - 3.2. Technically permissible maximum laden mass as stated by the manufacturer: .

4. DESCRIPTION OF ENERGY CONVERTERS

4.1. Engine manufacturer:

4.1.1. Manufacturer's engine code (as marked on the engine, or other means of identification):

4.2. Internal combustion engine

4.2.1. Specific engine information:

4.2.1.1. Working principle: positive-ignition/compression-ignition, four-stroke/two-stroke 1/

4.2.1.2. Number, arrangement and firing order of cylinders:

4.2.1.2.1. Bore: 3/ mm

4.2.1.2.2. Stroke: 3/ mm

4.2.1.3. Engine capacity: 4/ cm³

4.2.1.4. Volumetric compression ratio: 2/

4.2.1.5. Drawings of combustion chamber and piston crown:

4.2.1.6. Normal engine idling speed: 2/

4.2.1.7. High idle engine speed: 2/

4.2.1.8. Carbon monoxide content by volume in the exhaust gas with the engine idling (according to the manufacturer's specifications) 2/ per cent

4.2.1.9. Maximum net power: 2/..... kW at..... min.⁻¹

4.2.2. Fuel: diesel/petrol/LPG/NG 1/

4.2.3. Research octane number (RON):

4.2.4. Fuel feed

4.2.4.1. By carburettor(s): yes/no 1/

- 4.2.4.1.1. Make(s):.....
- 4.2.4.1.2. Type(s):
- 4.2.4.1.3. Number fitted:
- 4.2.4.1.4. Adjustments: 2/.....
- 4.2.4.1.4.1. Jets:
- 4.2.4.1.4.2. Venturis:
- 4.2.4.1.4.3. Float-chamber level:.....
- 4.2.4.1.4.4. Mass of float:.....
- 4.2.4.1.4.5. Float needle:
- 4.2.4.1.5. Cold start system: manual/automatic 1/
- 4.2.4.1.5.1. Operating principle:.....
- 4.2.4.1.5.2. Operating limits/settings: 1/2/
- 4.2.4.2. By fuel injection (compression-ignition only): yes/no 1/
- 4.2.4.2.1. System description:
- 4.2.4.2.2. Working principle: direct-injection/pre-chamber/swirl chamber 1/
- 4.2.4.2.3. Injection pump
- 4.2.4.2.3.1. Make(s):.....
- 4.2.4.2.3.2. Type(s):
- 4.2.4.2.3.3. Maximum fuel delivery: 1/2/ mm³/stroke or cycle at a pump speed of: 1/2/min.⁻¹ or characteristic diagram:
- 4.2.4.2.3.4. Injection timing: 2/
- 4.2.4.2.3.5. Injection advance curve: 2/.....

- 4.2.4.2.3.6. Calibration procedure: test bench/engine 1/
- 4.2.4.2.4. Governor
 - 4.2.4.2.4.1. Type:.....
 - 4.2.4.2.4.2. Cut-off point:
 - 4.2.4.2.4.2.1. Cut-off point under load: min⁻¹
 - 4.2.4.2.4.2.2. Cut-off point without load: min⁻¹
 - 4.2.4.2.4.3. Idling speed: min⁻¹
 - 4.2.4.2.5. Injector(s):
 - 4.2.4.2.5.1. Make(s):.....
 - 4.2.4.2.5.2. Type(s):
 - 4.2.4.2.5.3. Opening pressure: 2/kPa or characteristic diagram:.....
.....
 - 4.2.4.2.6. Cold start system
 - 4.2.4.2.6.1. Make(s):.....
 - 4.2.4.2.6.2. Type(s):
 - 4.2.4.2.6.3. Description:
 - 4.2.4.2.7. Auxiliary starting aid
 - 4.2.4.2.7.1. Make(s):.....
 - 4.2.4.2.7.2. Type(s):
 - 4.2.4.2.7.3. Description:
- 4.2.4.3. By fuel injection (positive-ignition only): yes/no 1/
 - 4.2.4.3.1. System description:

4.2.4.3.2. Working principle: intake manifold (single/multi-point)/direct injection/other (specify)

- Control unit - type (or No.):)
- Fuel regulator - type:)
- Air-flow sensor - type:)
- Fuel distributor - type:) information to be given
- Pressure regulator - type:) in the case of continuous
- Micro-switch - type:) injection;
- Idle adjusting screw - type:) in the case of other
- Throttle housing - type:) systems, equivalent
- Water temperature sensor - type:) details
- Air temperature sensor - type:)
- Air temperature switch - type:)

Electromagnetic interference protection. Description and/or drawing: 1/
.....
.....

4.2.4.3.3. Make(s):.....

4.2.4.3.4. Type(s):

4.2.4.3.5. Injectors: Opening pressure: 1/ 2/ kPa
or characteristic diagram:

4.2.4.3.6. Injection timing:

4.2.4.3.7. Cold start system:

4.2.4.3.7.1. Operating principle(s):

4.2.4.3.7.2. Operating limits/settings: 1/ 2/

4.2.4.4. Feed pump

4.2.4.4.1. Pressure: 1/ 2/ kPa or characteristic diagram:

4.2.5. Ignition

4.2.5.1. Make(s):.....

4.2.5.2. Type(s):

- 4.2.5.3. Working principle:
- 4.2.5.4. Ignition advance curve: 2/
- 4.2.5.5. Static ignition timing: 2/..... degrees before TDC
- 4.2.5.6. Contact-point gap: 2/
- 4.2.5.7. Dwell-angle: 2/
- 4.2.5.8. Spark plugs
 - 4.2.5.8.1. Make:
 - 4.2.5.8.2. Type:
 - 4.2.5.8.3. Spark plug gap setting: mm
- 4.2.5.9. Ignition coil
 - 4.2.5.9.1. Make:
 - 4.2.5.9.2. Type:
- 4.2.5.10. Ignition condenser
 - 4.2.5.10.1. Make:
 - 4.2.5.10.2. Type:
- 4.2.6. Cooling system: liquid/air 1/
- 4.2.7. Intake system:
- 4.2.7.1. Pressure charger: yes/no 1/
 - 4.2.7.1.1. Make(s):
 - 4.2.7.1.2. Type(s):
 - 4.2.7.1.3. Description of the system (maximum charge pressure: kPa, waste-gate).....
- 4.2.7.2. Inter-cooler: yes/no 1/

- 4.2.7.3. Description and drawings of inlet pipes and their accessories (plenum chamber, heating device, additional air intakes, etc.):
.....
- 4.2.7.3.1. Intake manifold description (drawings and/or photographs):
.....
- 4.2.7.3.2. Air filter, drawings:, or
- 4.2.7.3.2.1. Make(s):.....
- 4.2.7.3.2.2. Type(s):
- 4.2.7.3.3. Intake silencer, drawings:, or
- 4.2.7.3.3.1. Make(s):.....
- 4.2.7.3.3.2. Type(s):
- 4.2.8. Exhaust system
- 4.2.8.1. Description and drawings of the exhaust system:.....
- 4.2.9. Valve timing or equivalent data:
- 4.2.9.1. Maximum lift of valves, angles of opening and closing, or timing details of alternative distribution systems, in relation to dead centres:.....
- 4.2.9.2. Reference and/or setting ranges: 1/ 2/.....
- 4.2.10. Lubricant used:
- 4.2.10.1. Make:
- 4.2.10.2. Type:
- 4.2.11. Measures taken against air pollution:
- 4.2.11.1. Device for recycling crankcase gases (description and drawings):
- 4.2.11.2. Additional pollution control devices (if any, and if not covered by another heading):.....

- 4.2.11.2.1. Catalytic converter: yes/no 1/
- 4.2.11.2.1.1. Number of catalytic converters and elements:.....
- 4.2.11.2.1.2. Dimensions and shape of the catalytic converter(s) (volume,...):
- 4.2.11.2.1.3. Type of catalytic action:
- 4.2.11.2.1.4. Total charge of precious metal:
- 4.2.11.2.1.5. Relative concentration:
- 4.2.11.2.1.6. Substrate (structure and material):.....
- 4.2.11.2.1.7. Cell density:
- 4.2.11.2.1.8. Type of casing for catalytic converter(s):
- 4.2.11.2.1.9. Positioning of the catalytic converter(s) (place and reference distances in the exhaust system):.....
- 4.2.11.2.1.10. Regeneration systems/method of exhaust after-treatment systems, description:
- 4.2.11.2.1.10.1. The number of Type I operating cycles, or equivalent engine test bench cycles, between two cycles where regenerative phases occur under the conditions equivalent to Type I test (Distance 'D' in Figure 1 in Annex 13):
- 4.2.11.2.1.10.2. Description of method employed to determine the number of cycles between two cycles where regenerative phases occur:
- 4.2.11.2.1.10.3. Parameters to determine the level of loading required before regeneration occurs (i.e. temperature, pressure, etc.):
- 4.2.11.2.1.10.4. Description of method used to load system in the test procedure described in paragraph 3.1., Annex 13:
- 4.2.11.2.1.11. Oxygen sensor: type
- 4.2.11.2.1.11.1. Location of oxygen sensor:.....
- 4.2.11.2.1.11.2. Control range of oxygen sensor: 2/.....

- 4.2.11.2.2. Air injection: yes/no 1/
- 4.2.11.2.2.1. Type (pulse air, air pump,...):
- 4.2.11.2.3. Exhaust gas recirculation (EGR): yes/no 1/
- 4.2.11.2.3.1. Characteristics (flow,...):
- 4.2.11.2.4. Evaporative emission control system. Complete detailed description of the devices and their state of tune:
.....
Drawing of the evaporative control system:
- Drawing of the carbon canister:.....
- Drawing of the fuel tank with indication of capacity and material:
- 4.2.11.2.5. Particulate trap: yes/no 1/
- 4.2.11.2.5.1. Dimensions and shape of the particulate trap (capacity):
.....
- 4.2.11.2.5.2. Type of particulate trap and design:
- 4.2.11.2.5.3. Location of the particulate trap (reference distances in the exhaust system):.....
- 4.2.11.2.5.4. Regeneration system/method. Description and drawing:
.....
- 4.2.11.2.5.4.1. The number of Type I operating cycles, or equivalent engine test bench cycle, between two cycles where regeneration phases occur under the conditions equivalent to Type 1 test (Distance 'D' in Figure 1 in Annex 13):
- 4.2.11.2.5.4.2. Description of method employed to determine the number of cycles between two cycles where regenerative phases occur:
- 4.2.11.2.5.4.3. Parameters to determine the level of loading required before regeneration occurs (i.e. temperature, pressure, etc.):
- 4.2.11.2.5.4.4. Description of method used to load system in the test procedure described in paragraph 3.1., Annex 13:

- 4.2.11.2.6. Other systems (description and working principle):.....
.....
- 4.2.11.2.7. On-board-diagnostic (OBD) system
- 4.2.11.2.7.1. Written description and/or drawing of the malfunction indicator (MI):.....
.....
- 4.2.11.2.7.2. List and purpose of all components monitored by the OBD system:
.....
- 4.2.11.2.7.3. Written description (general working principles) for:
.....
- 4.2.11.2.7.3.1. Positive-ignition engines
- 4.2.11.2.7.3.1.1. Catalyst monitoring :
.....
- 4.2.11.2.7.3.1.2. Misfire detection :
.....
- 4.2.11.2.7.3.1.3. Oxygen sensor monitoring:.....
.....
- 4.2.11.2.7.3.1.4. Other components monitored by the OBD system:
.....
- 4.2.11.2.7.3.2. Compression-ignition engines
- 4.2.11.2.7.3.2.1. Catalyst monitoring:
.....
- 4.2.11.2.7.3.2.2. Particulate trap monitoring :
.....
- 4.2.11.2.7.3.2.3. Electronic fuelling system monitoring :.....
.....
- 4.2.11.2.7.3.2.4. Other components monitored by the OBD system :
.....
- 4.2.11.2.7.4. Criteria for MI activation (fixed number of driving cycles or statistical method):
.....
- 4.2.11.2.7.5. List of all OBD output codes and formats used (with explanation of each):.....
.....
.....

- 4.2.11.2.7.6. The following additional information must be provided by the vehicle manufacturer for the purposes of enabling the manufacture of OBD-compatible replacement or service parts and diagnostic tools and test equipment, unless such information is covered by intellectual property rights or constitutes specific know-how of the manufacturer or the OEM supplier(s).
- 4.2.11.2.7.6.1. A description of the type and number of the pre-conditioning cycles used for the original type approval of the vehicle.
- 4.2.11.2.7.6.2. A description of the type of the OBD demonstration cycle used for the original type-approval of the vehicle for the component monitored by the OBD system.
- 4.2.11.2.7.6.3. A comprehensive document describing all sensed components with the strategy for fault detection and MI activation (fixed number of driving cycles or statistical method), including a list of relevant secondary sensed parameters for each component monitored by the OBD system. A list of all OBD output codes and format used (with an explanation of each) associated with individual emission related power-train components and individual non-emission related components, where monitoring of the component is used to determine MI activation. In particular, a comprehensive explanation for the data given in service \$05 Test ID \$21 to FF and the data given in service \$06 must be provided. In the case of vehicle types that use a communication link in accordance with ISO 15765-4 'Road vehicles – Diagnostics on Controller Area Network (CAN) – Part 4: Requirements for emissions-related systems', a comprehensive explanation for the data given in service \$06 Test ID \$00 to FF, for each OBD monitor ID supported, must be provided.
- 4.2.11.2.7.6.4. The information required by this paragraph may, for example, be defined by completing a table as follows, which shall be attached to this Annex:

Component	Fault code	Monitoring strategy	Fault detection criteria	MI activation criteria	Secondary parameters	Preconditioning	Demonstration test
Catalyst	P0420	Oxygen sensor 1 and 2 signals	Difference between sensor 1 and sensor 2 signals	3 rd cycle	Engine speed, engine load, A/F mode, catalyst temperature	Two Type I cycles	Type I

- 4.2.12. LPG fuelling system: yes/no 1/
- 4.2.12.1. Approval number:.....
- 4.2.12.2. Electronic engine management control unit for LPG fuelling
- 4.2.12.2.1. Make(s):
- 4.2.12.2.2. Type(s):.....
- 4.2.12.2.3. Emission-related adjustment possibilities:.....
- 4.2.12.3. Further documentation:.....
- 4.2.12.3.1. Description of the safeguarding of the catalyst at switch-over from petrol to LPG or back:.....
- 4.2.12.3.2. System layout (electrical connections, vacuum connections, compensation hoses, etc.):
- 4.2.12.3.3. Drawing of the symbol:
- 4.2.13. NG fuelling system: yes/no 1/
- 4.2.13.1. Approval number:.....
- 4.2.13.2. Electronic engine management control unit for NG fuelling
- 4.2.13.2.1. Make(s):
- 4.2.13.2.2. Type(s):.....
- 4.2.13.2.3. Emission-related adjustment possibilities:.....
- 4.2.13.3. Further documentation:.....
- 4.2.13.3.1. Description of the safeguarding of the catalyst at switch-over from petrol to NG or back:
- 4.2.13.3.2. System layout (electrical connections, vacuum connections, compensation hoses, etc.):
- 4.2.13.3.3. Drawing of the symbol:

- 4.3. Hybrid Electric Vehicle : yes/no 1/
- 4.3.1. Category of Hybrid Electric vehicle : Off Vehicle Charging/Not Off Vehicle Charging 1/
- 4.3.2. Operating mode switch : with/without 1/
- 4.3.2.1. Selectable modes
- 4.3.2.1.1. Pure electric : yes/no 1/
- 4.3.2.1.2. Pure fuel consuming : yes/no 1/
- 4.3.2.1.3. Hybrid modes : yes/no 1/
(if yes, short description)
- 4.3.3. Description of the energy storage device: (battery, capacitor, flywheel/generator ...)
- 4.3.3.1. Make:
- 4.3.3.2. Type:
- 4.3.3.3. Identification number:
- 4.3.3.4. Kind of electrochemical couple:
- 4.3.3.5. Energy: (for battery: voltage and capacity Ah in 2 h, for capacitor: J, ...)
- 4.3.3.6. Charger: on board/ external/ without 1/
- 4.3.4. Electric machines (describe each type of electric machine separately)
- 4.3.4.1. Make:
- 4.3.4.2. Type:
- 4.3.4.3. Primary use: traction motor / generator
- 4.3.4.3.1. When used as traction motor: monomotor/ multimotors (number):
- 4.3.4.4. Maximum power: kW
- 4.3.4.5. Working principle:
- 4.3.4.5.1. direct current/ alternating current/ number of phases:

- 4.3.4.5.2. separate excitation/ series/ compound 1/
- 4.3.4.5.3. synchronous / asynchronous 1/
- 4.3.5. Control unit
 - 4.3.5.1. Make:
 - 4.3.5.2. Type:
 - 4.3.5.3. Identification number:
- 4.3.6. Power controller
 - 4.3.6.1. Make:
 - 4.3.6.2. Type:
 - 4.3.6.3. Identification number:
- 4.3.7. Vehicle electric range km (according Annex 7 of Regulation No. 101):
- 4.3.8. Manufacturer's recommendation for preconditioning:

- 5. TRANSMISSION
 - 5.1. Clutch (type):
 - 5.1.1. Maximum torque conversion:
 - 5.2. Gearbox:
 - 5.2.1. Type:
 - 5.2.2. Location relative to the engine:
 - 5.2.3. Method of control:

5.3. Gear ratios

Index	Gearbox ratios	Final drive ratios	Total ratios
Maximum for CVT (*)			
1			
2			
3			
4, 5, others			
Minimum for CVT (*)			
Reverse			

(*) CVT – Continuously variable transmission

5.4. Hybrid electric vehicle

5.4.1. Drawing of the hybrid powertrain system layout
(engine/motor/transmission combination):

5.4.2. Description of the general hybrid powertrain working principle:

6. SUSPENSION

6.1. Tyres and wheels

6.1.1. Tyre/wheel combination(s) (for tyres indicate size designation, minimum load-capacity index, minimum speed category symbol; for wheels, indicate rim size(s) and off-set(s):

6.1.1.1. Axles

6.1.1.1.1. Axle 1:

6.1.1.1.2. Axle 2:

6.1.1.1.3. Axle 3:

6.1.1.1.4. Axle 4: etc.

6.1.2. Upper and lower limit of rolling circumference:

6.1.2.1. Axles

6.1.2.1.1. Axle 1:

6.1.2.1.2. Axle 2:

6.1.2.1.3. Axle 3:

6.1.2.1.4. Axle 4: etc.

6.1.3. Tyre pressure(s) recommended by the manufacturer:
.....kPa

7. BODYWORK

7.1. Number of seats:

1/ Strike out what does not apply.

2/ Specify the tolerance.

3/ This value shall be rounded-off to the nearest tenth of a millimetre.

4/ This value shall be calculated with $\pi = 3.1416$ and rounded-off to the nearest cm^3 .

Annex 2

COMMUNICATION

(maximum format: A4 (210 x 297 mm))

issued by:

Name of administration:

.....
.....
.....

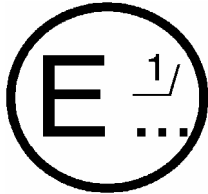

concerning: 2/ APPROVAL GRANTED
APPROVAL EXTENDED
APPROVAL REFUSED
APPROVAL WITHDRAWN
PRODUCTION DEFINITELY DISCONTINUED

of a vehicle type with regard to the emission of gaseous pollutants by the engine pursuant to Regulation No. 83

Approval No.

Extension No.

- 1. Category of the vehicle type (M1, N1, etc.):.....
- 1.1. Hybrid electric vehicle: yes/no 2/.....
- 1.1.1. Category of Hybrid Electric vehicle: Off Vehicle Charging/Not Off Vehicle Charging 2/
- 1.1.2. Operating mode switch: with/without 2/.....
- 2. Engine fuel requirements: petrol/diesel/LPG/CNG: 2/
- 3. Trade name or mark of the vehicle:.....
- 4. Vehicle type: Engine type:

5. Manufacturer's name and address:
6. If applicable, name and address of manufacturer's representative:
.....
7. Unladen mass of the vehicle:.....
- 7.1. Reference mass of the vehicle:
8. Maximum mass of the vehicle:
9. Number of seats (including the driver):
10. Transmission
- 10.1. Manual or automatic or continuously variable transmission: 2/ 3/
- 10.2. Number of gear ratios:.....
- 10.3. Transmission ratio of gearbox: 2/
First gear N/V:
- Second gear N/V:.....
- Third gear N/V:.....
- Fourth gear N/V:
- Fifth gear N/V:.....
- Final drive ratio:.....
- Range of tyre sizes:
- Rolling circumference of tyres used for the Type I test:
- Wheel drive: front, rear, 4 x 4: 2/.....
11. Vehicle submitted for test on:
12. Technical service conducting approval tests:
13. Date of report issued by that service:
14. Number of report issued by that service:.....
15. Approval granted/refused/extended/withdrawn: 2/

16. Test results:

16.1. Test Type I:

Pollutant in g/km	CO	HC (3)	NO _x	HC + NO _x (1)	Particulates (1)
Measured					
With factor K _i (2)					
With deterioration factor					

- (1) For compression-ignition engines only.
- (2) For vehicles equipped with periodically regenerating systems as defined in paragraph 2.20. of this Regulation, the measured values must be multiplied by the factors K_i obtained from Annex 13.
- (3) For positive-ignition engines only.

16.1.1. In the case of vehicles fuelled with LPG or NG:

16.1.1.1. Repeat the table for all reference gases of LPG or NG, showing if results are measured or calculated. In the case of vehicles designed to run either on petrol or on LPG or NG: repeat for petrol and all reference gases of LPG or NG.

16.1.1.2. Approval number of the parent vehicle, if the vehicle is a member of a family:
.....

16.1.1.3. Ratios “r” of emission results for the family in the case of gaseous fuels for each pollutant:

16.1.2. In the case of externally chargeable (OVC) Hybrid Electric Vehicle:

16.1.2.1. Repeat the table for the both test conditions specified in paragraphs 3.1. and 3.2. of Annex 14.

16.1.2.2. Repeat the table for the weighted values determined according to paragraphs 3.1.4. or 3.2.4. of Annex 14.

16.2. Test Type II: 2/
CO: per cent at idling speed: min.⁻¹
(measured at the exhaust).

16.3. Test Type III: 2/

16.4. Test Type IV: 2/ g/test

16.5. Test Type V: Durability

16.5.1. Type of durability test: 80,000 km/not applicable: 2/

16.5.2. Deterioration factors (DF): calculated/fixed 2/
Specify the values:

16.6. Test Type VI: 2/

	CO (g/km)	HC (g/km)
Measured value		

16.7. OBD test

16.7.1. Written description and/or drawing of the malfunction indicator (MI):
.....

16.7.2. List and function of all components monitored by the OBD system:
.....

16.7.3. Written description (general working principles) for:

16.7.3.1. Misfire detection:

16.7.3.2. Catalyst monitoring :

16.7.3.3. Oxygen sensor monitoring :

16.7.3.4. Other components monitored by the OBD system:

16.7.3.5. Particulate trap monitoring:

16.7.3.6. Electronic fuelling system actuator monitoring :

16.7.3.7. Other components monitored by the OBD system :

16.7.4. Criteria for MI activation (fixed number of driving cycles or statistical method):

16.7.5. List of all OBD output codes and formats used (with explanation of each):.....

17. Emissions data required for roadworthiness testing

Test	CO value (per cent vol.)	Lambda (1)	Engine speed (min ⁻¹)	Engine oil temperature (°C)
Low idle test		N/A		
High idle test				

(1) Lambda formula: see paragraph 5.3.7.3. of this Regulation

18. Make and type of catalytic converters (s) as listed in item 4.2.11.2.1. of Annex 1 to this Regulation.

19. Position of approval mark on vehicle:

20. Place:

21. Date:

22. Signature:

1/ Distinguishing number of the country which has granted/extended/refused/withdrawn the approval (see approval provisions in the Regulation).

2/ Strike out what does not apply.

3/ In the case of vehicles equipped with automatic-shift gearboxes, give all pertinent technical data.

Annex 2 – Appendix 1

OBD – RELATED INFORMATION

As noted in item 4.2.11.2.7.6. of the information document in Annex 1 of this Regulation, the information in this Appendix is provided by the vehicle manufacturer for the purposes of enabling the manufacture of OBD-compatible replacement or service parts and diagnostic tools and test equipment. Such information need not be supplied by the vehicle manufacturer if it is covered by intellectual property rights or constitutes specific know-how of the manufacturer or the OEM supplier(s).

Upon request, this Appendix will be made available to any interested component, diagnostic tools or test equipment manufacturer, on a non-discriminatory basis.

1. A description of the type and number of the pre-conditioning cycles used for the original type approval of the vehicle.
2. A description of the type of the OBD demonstration cycle used for the original type approval of the vehicle for the component monitored by the OBD system.
3. A comprehensive document describing all sensed components with the strategy for fault detection and MI activation (fixed number of driving cycles or statistical method), including a list of relevant secondary sensed parameters for each component monitored by the OBD system. A list of all OBD output codes and format used (with an explanation of each) associated with individual emission related power-train components and individual non-emission related components, where monitoring of the component is used to determine MI activation. In particular, a comprehensive explanation for the data given in service \$05 Test ID \$21 to FF and the data given in service \$06 must be provided. In the case of vehicle types that use a communication link in accordance with ISO 15765-4 ‘Road vehicles – Diagnostics on Controller Area Network (CAN) – Part 4: Requirements for emissions-related systems’, a comprehensive explanation for the data given in service \$06 Test ID \$00 to FF, for each OBD monitor ID supported, must be provided.

This information may be defined in the form of a table, as follows:

Component	Fault code	Monitoring strategy	Fault detection criteria	MI activation criteria	Secondary parameters	Pre-conditioning	Demonstration test
Catalyst	P0420	Oxygen sensor 1 and 2 signals	Difference between sensor 1 and sensor 2 signals	3rd cycle	Engine speed, engine load, A/F mode, catalyst temperature	Two Type I cycles	Type I

Annex 3

ARRANGEMENTS OF THE APPROVAL MARK

Approval B (Row A) 1/ - Vehicles approved to the emission levels of gaseous pollutants required for feeding the engine with petrol (unleaded) or with unleaded petrol and either LPG or NG.

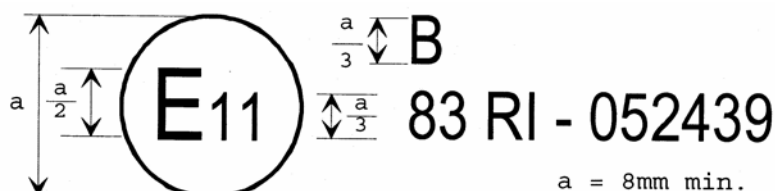

The above approval mark affixed to a vehicle in conformity with paragraph 4. of this Regulation shows that the vehicle type concerned has been approved in the United Kingdom (E11), pursuant to Regulation No. 83 under approval number 052439. This approval indicates that the approval was given in accordance with the requirements of Regulation No. 83 with the 05 series of amendments incorporated and satisfying the limits for the Type I test detailed in Row A (2000) of the table in paragraph 5.3.1.4. of this Regulation.

Approval B, (Row B) 1/ - Vehicles approved to the emission levels of gaseous pollutants required for feeding the engine with petrol (unleaded) or with either unleaded petrol or LPG or NG.

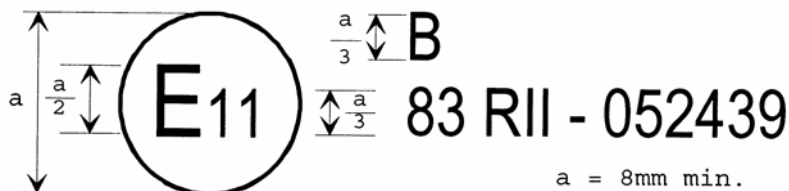

The above approval mark affixed to a vehicle in conformity with paragraph 4. of this Regulation shows that the vehicle type concerned has been approved in the United Kingdom (E11), pursuant to Regulation No. 83 under approval number 052439. This approval indicates that the approval was given in accordance with the requirements of Regulation No. 83 with the 05 series of amendments incorporated and satisfying the limits for the Type I test detailed in Row B (2005) of the table in paragraph 5.3.1.4. of this Regulation.

Approval C (Row A) 1/ - Vehicles approved to the emission levels of gaseous pollutants required for feeding the engine with diesel fuel.

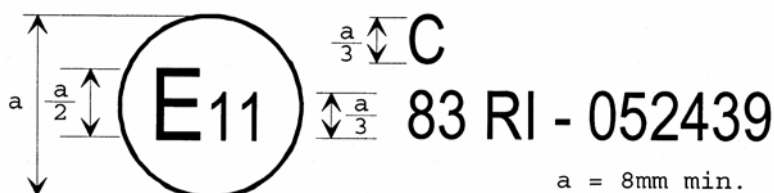

The above approval mark affixed to a vehicle in conformity with paragraph 4. of this Regulation shows that the vehicle type concerned has been approved in the United Kingdom (E11), pursuant to Regulation No. 83 under approval number 052439. This approval indicates that the approval was given in accordance with the requirements of Regulation No. 83 with the 05 series of amendments incorporated and satisfying the limits for the Type I test detailed in Row A (2000) of the table in paragraph 5.3.1.4. of this Regulation.

Approval C (Row B) 1/ - Vehicles approved to the emission levels of gaseous pollutants required for feeding the engine with diesel fuel.

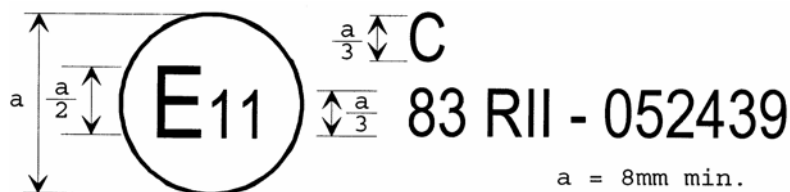

The above approval mark affixed to a vehicle in conformity with paragraph 4. of this Regulation shows that the vehicle type concerned has been approved in the United Kingdom (E11), pursuant to Regulation No. 83 under approval number 052439. This approval indicates that the approval was given in accordance with the requirements of Regulation No. 83 with the 05 series of amendments incorporated and satisfying the limits for the Type I test detailed in Row B (2005) of the table in paragraph 5.3.1.4. of this Regulation.

Approval D, (Row A) 1/ - Vehicles approved to the emission levels of gaseous pollutants required for feeding the engine with LPG or NG.

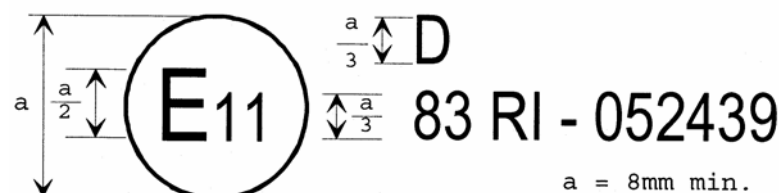

The above approval mark affixed to a vehicle in conformity with paragraph 4. of this Regulation shows that the vehicle type concerned has been approved in the United Kingdom (E11), pursuant to Regulation No. 83 under approval number 052439. This approval indicates that the approval was given in accordance with the requirements of Regulation No. 83 with the 05 series of amendments incorporated and satisfying the limits for the Type I test detailed in Row A (2000) of the table in paragraph 5.3.1.4. of this Regulation.

Approval D, (Row B) 1/ - Vehicles approved to the emission levels of gaseous pollutants required for feeding the engine with LPG or NG.

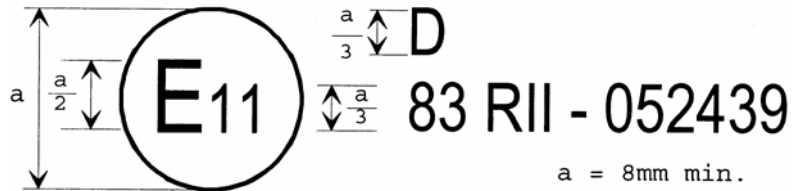

The above approval mark affixed to a vehicle in conformity with paragraph 4. of this Regulation shows that the vehicle type concerned has been approved in the United Kingdom (E11), pursuant to Regulation No. 83 under approval number 052439. This approval indicates that the approval was given in accordance with the requirements of Regulation No. 83 with the 05 series of amendments incorporated and satisfying the limits for the Type I test detailed in Row B (2005) of the table in paragraph 5.3.1.4. of this Regulation.

1/ See paras. 2.19. and 5.3.1.4. of this Regulation.

Annex 4

TYPE I TEST

(Verifying exhaust emissions after a cold start)

1. INTRODUCTION

This Annex describes the procedure for the Type I test defined in paragraph 5.3.1. of this Regulation. When the reference fuel to be used is LPG or NG, the provisions of Annex 12 shall apply additionally.

When the vehicle is equipped with a periodically regenerating system as defined in paragraph 2.20., the provisions of Annex 13 shall apply.

2. OPERATING CYCLE ON THE CHASSIS DYNAMOMETER

2.1. Description of the cycle

The operating cycle on the chassis dynamometer shall be that indicated in the Appendix 1 to this Annex.

2.2. General conditions under which the cycle is carried out

Preliminary testing cycles should be carried out if necessary to determine how best to actuate the accelerator and brake controls so as to achieve a cycle approximating to the theoretical cycle within the prescribed limits.

2.3. Use of the gearbox

- 2.3.1. If the maximum speed which can be attained in first gear is below 15 km/h, the second, third and fourth gears shall be used for the urban cycle (Part One) and the second, third, fourth and fifth gears for the extra-urban cycle (Part Two). The second, third and fourth gears may also be used for the urban cycle (Part One) and the second, third, fourth and fifth gears for the extra-urban cycle (Part Two) when the manufacturer's instructions recommend starting in second gear on level ground, or when first gear is therein defined as a gear reserved for cross-country driving, crawling or towing.

Vehicles which do not attain the acceleration and maximum speed values required in the operating cycle shall be operated with the accelerator control fully depressed until they once again reach the required operating curve. Deviations from the operating cycle shall be recorded in the test report.

- 2.3.2. Vehicles equipped with semi-automatic-shift gearboxes shall be tested by using the gears normally employed for driving, and the gear shift is used in accordance with the manufacturer's instructions.
- 2.3.3. Vehicles equipped with automatic-shift gearboxes shall be tested with the highest gear ("Drive") engaged. The accelerator shall be used in such a way as to obtain the steadiest acceleration possible, enabling the various gears to be engaged in the normal order. Furthermore, the gear-change points shown in Appendix 1 to this Annex shall not apply; acceleration shall continue throughout the period represented by the straight line connecting the end of each period of idling with the beginning of the next following period of steady speed. The tolerances given in paragraph 2.4. below shall apply.
- 2.3.4. Vehicles equipped with an overdrive which the driver can actuate shall be tested with the overdrive out of action for the urban cycle (Part One) and with the overdrive in action for the extra-urban cycle (Part Two).
- 2.3.5. At the request of the manufacturer, for a vehicle type where the idle speed of the engine is higher than the engine speed that would occur during operations 5, 12 and 24 of the elementary urban cycle (Part One), the clutch may be disengaged during the previous operation.
- 2.4. Tolerances
- 2.4.1. A tolerance of ± 2 km/h shall be allowed between the indicated speed and the theoretical speed during acceleration, during steady speed, and during deceleration when the vehicle's brakes are used. If the vehicle decelerates more rapidly without the use of the brakes, only the provisions of paragraph 6.5.3. below shall apply. Speed tolerances greater than those prescribed shall be accepted during phase changes provided that the tolerances are never exceeded for more than 0.5 s on any one occasion.
- 2.4.2. The time tolerances shall be ± 1.0 s. The above tolerances shall apply equally at the beginning and at the end of each gear-changing period ^{1/} for the urban cycle (Part One) and for the operations No. 3, 5 and 7 of the extra-urban cycle (Part Two).
- 2.4.3. The speed and time tolerances shall be combined as indicated in Appendix 1 to this Annex.

^{1/} It should be noted that the time of two seconds allowed includes the time for changing gear and, if necessary, a certain amount of latitude to catch up with the cycle.

3. VEHICLE AND FUEL

3.1. Test vehicle

3.1.1. The vehicle shall be presented in good mechanical condition. It shall have been run in and driven at least 3,000 km before the test.

3.1.2. The exhaust device shall not exhibit any leak likely to reduce the quantity of gas collected, which quantity shall be that emerging from the engine.

3.1.3. The tightness of the intake system may be checked to ensure that carburation is not affected by an accidental intake of air.

3.1.4. The settings of the engine and of the vehicle's controls shall be those prescribed by the manufacturer. This requirement also applies, in particular, to the settings for idling (rotation speed and carbon monoxide content of the exhaust gases), for the cold start device and for the exhaust gas cleaning system.

3.1.5. The vehicle to be tested, or an equivalent vehicle, shall be fitted, if necessary, with a device to permit the measurement of the characteristic parameters necessary for chassis dynamometer setting, in conformity with paragraph 4.1.1. of this Annex.

3.1.6. The technical service responsible for the tests may verify that the vehicle's performance conforms to that stated by the manufacturer, that it can be used for normal driving and, more particularly, that it is capable of starting when cold and when hot.

3.2. Fuel

When testing a vehicle against the emission limit values given in row A of the table in paragraph 5.3.1.4. of this Regulation, the appropriate reference fuel must comply with the specifications given in paragraph 1. of Annex 10 or, in the case of gaseous reference fuels, either paragraph 1.1.1. or paragraph 1.2. of Annex 10a.

When testing a vehicle against the emission limit values given in row B of the table in paragraph 5.3.1.4. of this Regulation, the appropriate reference fuel must comply with the specifications given in paragraph 2. of Annex 10 or, in the case of gaseous reference fuels, either paragraph 1.1.2. or paragraph 1.2. of Annex 10a.

3.2.1. Vehicles that are fuelled either with petrol or with LPG or NG shall be tested according to Annex 12 with the appropriate reference fuel(s) as defined in Annex 10a.

4. TEST EQUIPMENT

4.1. Chassis dynamometer

4.1.1. The dynamometer shall be capable of simulating road load within one of the following classifications:

dynamometer with fixed load curve, i.e. a dynamometer whose physical characteristics provide a fixed load curve shape,
dynamometer with adjustable load curve, i.e. a dynamometer with at least two road load parameters that can be adjusted to shape the load curve.

4.1.2. The setting of the dynamometer shall not be affected by the lapse of time. It shall not produce any vibrations perceptible to the vehicle and likely to impair the vehicle's normal operations.

4.1.3. It shall be equipped with means to simulate inertia and load. These simulators are connected to the front roller in the case of a two-roller dynamometer.

4.1.4. Accuracy

4.1.4.1. It shall be possible to measure and read the indicated load to an accuracy of ± 5 per cent.

4.1.4.2. In the case of a dynamometer with a fixed load curve, the accuracy of the load setting at 80 km/h shall be ± 5 per cent. In the case of a dynamometer with adjustable load curve, the accuracy of matching dynamometer load to road load shall be ± 5 per cent at 120, 100, 80, 60, and 40 km/h and ± 10 per cent at 20 km/h. Below this, dynamometer absorption shall be positive.

4.1.4.3. The total inertia of the rotating parts (including the simulated inertia where applicable) shall be known and shall be within ± 20 kg of the inertia class for the test.

4.1.4.4. The speed of the vehicle shall be measured by the speed of rotation of the roller (the front roller in the case of a two-roller dynamometer). It shall be measured with an accuracy of ± 1 km/h at speeds above 10 km/h.

4.1.4.5. The distance actually driven by the vehicle shall be measured by the movement of rotation of the roller (the front roller in the case of a two-roller dynamometer).

4.1.5. Load and inertia setting

4.1.5.1. Dynamometer with fixed load curve: the load simulator shall be adjusted to absorb the power exerted on the driving wheels at a steady speed of 80 km/h and the absorbed power at 50 km/h shall be noted. The means by which this load is determined and set are described in Appendix 3 to this Annex.

4.1.5.2. Dynamometer with adjustable load curve: the load simulator shall be adjusted in order to absorb the power exerted on the driving wheels at steady speeds of 120, 100, 80, 60 and 40 and 20 km/h. The means by which these loads are determined and set are described in Appendix 3 to this Annex.

4.1.5.3. Inertia

Dynamometers with electric inertia simulation shall be demonstrated to be equivalent to mechanical inertia systems. The means by which equivalence is established are described in Appendix 4 to this Annex.

4.2. Exhaust gas-sampling system

4.2.1. The exhaust gas sampling system shall be able to measure the actual quantities of pollutants emitted in the exhaust gases to be measured. The system that shall be used is the constant volume sampler (CVS) system. This requires that the vehicle exhaust be continuously diluted with ambient air under controlled conditions. In the constant volume sampler concept of measuring mass emissions, two conditions shall be satisfied, the total volume of the mixture of exhaust and dilution air shall be measured and a continuously proportional sample of the volume shall be collected for analysis. The quantities of pollutants are determined from the sample concentrations, corrected for the pollutant content of the ambient air and the totalised flow over the test period.

The particulate pollutant emission level is determined by using suitable filters to collect the particulates from a proportional part flow throughout the test and determining the quantity thereof gravimetrically in accordance with paragraph 4.3.1.1.

4.2.2. The flow through the system shall be sufficient to eliminate water condensation at all conditions which may occur during a test, as defined in Appendix 5 to this Annex.

4.2.3. Appendix 5 gives examples of three types of constant volume sampler system which satisfy the requirements of this Annex.

- 4.2.4. The gas and air mixture shall be homogeneous at point S2 of the sampling probe.
- 4.2.5. The probe shall extract a true sample of the diluted exhaust gases.
- 4.2.6. The system shall be free of gas leaks. The design and materials shall be such that the system does not influence the pollutant concentration in the diluted exhaust gas. Should any component (heat exchanger, blower, etc.) change the concentration of any pollutant gas in the diluted gas, the sampling for that pollutant shall be carried out before that component if the problem cannot be corrected.
- 4.2.7. If the vehicle being tested is equipped with an exhaust pipe comprising several branches, the connecting tubes shall be connected as near as possible to the vehicle without adversely affecting his operation.
- 4.2.8. Static pressure variations at the exhaust(s) of the vehicle shall remain within ± 1.25 kPa of the static pressure variations measured during the dynamometer driving cycle and with no connection to the exhaust(s). Sampling systems capable of maintaining the static pressure to within ± 0.25 kPa are used if a written request from a manufacturer to the administration granting the approval substantiates the need for the closer tolerance. The back-pressure shall be measured in the exhaust pipe as near as possible to its end or in an extension having the same diameter.
- 4.2.9. The various valves used to direct the exhaust gases shall be of a quick-adjustment, quick-acting type.
- 4.2.10. The gas samples are collected in sample bags of adequate capacity. These bags shall be made of such materials as will not change the pollutant gas by more than ± 2 per cent after 20 minutes of storage.

4.3. Analytical equipment

4.3.1. Provisions

- 4.3.1.1. Pollutant gases shall be analysed with the following instruments:

Carbon monoxide (CO) and carbon dioxide (CO₂) analysis:

Analysers shall be of the non-dispersive infra-red (NDIR) absorption type.

Hydrocarbons (HC) analysis - spark-ignition engines:

The analyser shall be of the flame ionisation (FID) type calibrated with propane gas expressed equivalent to carbon atoms (C₁).

Hydrocarbons (HC) analysis - compression-ignition engines:

The analyser shall be of the flame ionisation type with detector, valves, pipework, etc., heated to 463 K (190 °C) ± 10 K (HFID). It shall be calibrated with propane gas expressed equivalent to carbon atoms (C₁).

Nitrogen oxide (NO_x) analysis:

The analyser shall be either of the chemi-luminescent (CLA) or of the non-dispersive ultra-violet resonance absorption (NDUVR) type, both with an NO_x-NO converter.

Particulates - Gravimetric determination of the particulates collected:

These particulates shall in each case be collected by two series-mounted filters in the sample gas flow. The quantity of particulates collected by each pair of filters shall be as follows:

$$M = \frac{V_{\text{mix}}}{V_{\text{ep}} \cdot d} \cdot m \rightarrow m = M \cdot d \cdot \frac{V_{\text{ep}}}{V_{\text{mix}}}$$

where:

V_{ep} : flow through filters;

V_{mix} : flow through tunnel;

M : particulate mass (g/km);

M_{limit} : limit mass of particulates (limit mass in force, g/km);

m : mass of particulates collected by filters (g);

d : distance corresponding to the operating cycle (km).

The particulates sample rate (V_{ep}/V_{mix}) shall be adjusted so that for M = M_{limit}, 1 ≤ m ≤ 5 mg (when 47 mm diameter filters are used).

The filter surface shall consist of a material that is hydrophobic and inert towards the components of the exhaust gas (fluorocarbon coated glass fibre filters or equivalent).

4.3.1.2. Accuracy

The analysers shall have a measuring range compatible with the accuracy required to measure the concentrations of the exhaust gas sample pollutants.

Measurement error shall not exceed ± 2 per cent (intrinsic error of analyser) disregarding the true value for the calibration gases.

For concentrations of less than 100 ppm the measurement error shall not exceed ± 2 ppm.

The ambient air sample shall be measured on the same analyser with an appropriate range.

The microgram balance used to determine the weight of all filters shall have accuracy of 5 μg (standard deviation) and readability of 1 μg .

4.3.1.3. Ice-trap

No gas drying device shall be used before the analysers unless shown to have no effect on the pollutant content of the gas stream.

4.3.2. Particular requirements for compression-ignition engines

A heated sample line for a continuous HC-analysis with the flame ionisation detector (HFID), including recorder (R) shall be used. The average concentration of the measured hydrocarbons shall be determined by integration. Throughout the test, the temperature of the heated sample line shall be controlled at 463 K (190 °C) ± 10 K. The heated sampling line shall be fitted with a heated filter (F_H) 99 per cent efficient with particles $\geq 0.3 \mu\text{m}$, to extract any solid particles from the continuous flow of gas required for analysis.

The sampling system response time (from the probe to the analyser inlet) shall be no more than four seconds.

The HFID shall be used with a constant flow (heat exchanger) system to ensure a representative sample, unless compensation for varying CFV or CFO flow is made.

The particulate sampling unit shall consist of a dilution tunnel, a sampling probe, a filter unit, a partial-flow pump, and flow rate regulators and measuring units. The particulate-sampling part flow is drawn through two series-mounted filters. The sampling probe for the test gas flow for particulates shall be so arranged within the dilution tract that a representative sample gas flow can be taken from the homogeneous air/exhaust mixture and an air/exhaust gas mixture temperature of 325 K (52 °C) is not exceeded immediately before the particulate filter. The temperature of the gas flow in the flow metre may not fluctuate by more than ± 3 K, nor may the mass flow rate fluctuate by more than ± 5 per cent. Should the volume of flow change unacceptably as a result of excessive filter loading, the test shall be stopped. When it is repeated, the rate of flow shall be decreased and/or a larger filter used. The filters shall be removed from the chamber no earlier than an hour before the test begins.

The necessary particle filters shall be conditioned (as regards temperature and humidity) in an open dish which has been protected against dust ingress for at least 8 and for not more than 56 hours before the test in an air-conditioned chamber. After this conditioning the uncontaminated filters will be weighed and stored until they are used. If the filters are not used within one hour of their removal from the weighing chamber they shall be re-weighed.

The one-hour limit may be replaced by an eight-hour limit if one or both of the following conditions are met;

a stabilised filter is placed and kept in a sealed filter holder assembly with the ends plugged, or;

a stabilised filter is placed in a sealed filter holder assembly which is then immediately placed in a sample line through which there is no flow.

4.3.3. Calibration

Each analyser shall be calibrated as often as necessary and in any case in the month before type approval testing and at least once every six months for verifying conformity of production.

The calibration method to be used is described in Appendix 6 to this Annex for the analysers referred to in paragraph 4.3.1. above.

4.4. Volume measurement

4.4.1. The method of measuring total dilute exhaust volume incorporated in the constant volume sampler shall be such that measurement is accurate to ± 2 per cent.

4.4.2. Constant volume sampler calibration

The constant volume sampler system volume measurement device shall be calibrated by a method sufficient to ensure the prescribed accuracy and at a frequency sufficient to maintain such accuracy.

An example of a calibration procedure which will give the required accuracy is given in Appendix 6 to this Annex. The method shall utilise a flow metering device which is dynamic and suitable for the high flow-rate encountered in constant volume sampler testing. The device shall be of certified accuracy traceable to an approved national or international standard.

4.5. Gases

4.5.1. Pure gases

The following pure gases shall be available, if necessary, for calibration and operation:

purified nitrogen:

(purity: ± 1 ppm C, ± 1 ppm CO, ± 400 ppm CO₂, ± 0.1 ppm NO);

purified synthetic air:

(purity: ± 1 ppm C, ± 1 ppm CO, ± 400 ppm CO₂, ± 0.1 ppm NO); oxygen content between 18 and 21 per cent volume;

purified oxygen: (purity > 99.5 per cent vol. O₂);

purified hydrogen (and mixture containing helium):

(purity ± 1 ppm C, ± 400 ppm CO₂);

carbon monoxide: (minimum purity 99.5 per cent);

propane: (minimum purity 99.5 per cent).

4.5.2. Calibration and span gases

Mixtures of gases having the following chemical compositions shall be available:

C₈H₈ and purified synthetic air (see paragraph 4.5.1. of this Annex);

CO and purified nitrogen;

CO₂ and purified nitrogen;

NO and purified nitrogen. (The amount of NO₂ contained in this calibration gas shall not exceed 5 per cent of the NO content.)

The true concentration of a calibration gas shall be within ± 2 per cent of the stated figure.

The concentrations specified in Appendix 6 to this Annex may also be obtained by means of a gas divider, diluting with purified N₂ or with purified synthetic air. The accuracy of the mixing device shall be such that the concentrations of the diluted calibration gases may be determined to within ± 2 per cent.

4.6. Additional equipment

4.6.1. Temperatures

The temperatures indicated in Appendix 8 shall be measured with an accuracy of ± 1.5 K.

4.6.2. Pressure

The atmospheric pressure shall be measurable to within ± 0.1 kPa.

4.6.3. Absolute humidity

The absolute humidity (H) shall be measurable to within ± 5 per cent.

4.7. The exhaust gas-sampling system shall be verified by the method described in paragraph 3. of Appendix 7 to this Annex.

The maximum permissible deviation between the quantity of gas introduced and the quantity of gas measured is 5 per cent.

5. PREPARING THE TEST

5.1. Adjustment of inertia simulators to the vehicle's translatory inertias

An inertia simulator shall be used enabling a total inertia of the rotating masses to be obtained proportional to the reference mass within the following limits:

Reference mass of vehicle RW(kg)	Equivalent inertia I(kg)
$RW \leq 480$	455
$480 < RW \leq 540$	510
$540 < RW \leq 595$	570
$595 < RW \leq 650$	625
$650 < RW \leq 710$	680
$710 < RW \leq 765$	740
$765 < RW \leq 850$	800
$850 < RW \leq 965$	910
$965 < RW \leq 1080$	1020
$1080 < RW \leq 1190$	1130
$1190 < RW \leq 1305$	1250
$1305 < RW \leq 1420$	1360
$1420 < RW \leq 1530$	1470
$1530 < RW \leq 1640$	1590
$1640 < RW \leq 1760$	1700
$1760 < RW \leq 1870$	1810
$1870 < RW \leq 1980$	1930
$1980 < RW \leq 2100$	2040
$2100 < RW \leq 2210$	2150
$2210 < RW \leq 2380$	2270
$2380 < RW \leq 2610$	2270
$2610 < RW$	2270

If the corresponding equivalent inertia is not available on the dynamometer, the larger value closest to the vehicle reference mass will be used.

5.2. Setting of dynamometer

The load shall be adjusted according to methods described in paragraph 4.1.5. above.

The method used and the values obtained (equivalent inertia - characteristic adjustment parameter) shall be recorded in the test report.

5.3. Conditioning of vehicle

5.3.1. For compression-ignition engines for the purpose of measuring particulates, at most 36 hours and at least 6 hours before testing, the Part Two cycle described in Appendix 1 to this Annex shall be used. Three consecutive cycles shall be driven. The dynamometer setting shall be indicated in paragraphs 5.1. and 5.2. above.

At the request of the manufacturer, vehicles fitted with positive-ignition engines may be preconditioned with one Part One and two Part Two driving cycles.

After this preconditioning, specific for compression-ignition engines, and before testing, compression-ignition and positive-ignition engines shall be kept in a room in which the temperature remains relatively constant between 293 and 303 K (20 and 30 °C). This conditioning shall be carried out for at least six hours and continue until the engine oil temperature and coolant, if any, are within ± 2 K of the temperature of the room.

5.3.1.1. If the manufacturer so requests, the test shall be carried out not later than 30 hours after the vehicle has been run at its normal temperature.

5.3.1.2. For positive-ignition engines fuelled with LPG or NG or so equipped that they can be fuelled with either petrol or LPG or NG, between the tests on the first gaseous reference fuel and the second gaseous reference fuel, the vehicle shall be preconditioned before the test on the second reference fuel. This preconditioning is done on the second reference fuel by driving a preconditioning cycle consisting of one Part One (urban part) and two times Part Two (extra-urban part) of the test cycle described in Appendix 1 to this Annex. On the manufacturer's request and with the agreement of the technical service this preconditioning may be extended. The dynamometer setting shall be the one indicated in paragraphs 5.1. and 5.2. of this Annex.

- 5.3.2. The tyre pressures shall be the same as that specified by the manufacturer and used for the preliminary road test for brake adjustment. The tyre pressure may be increased by up to 50 per cent from the manufacturer's recommended setting in the case of a two-roller dynamometer. The actual pressure used shall be recorded in the test report.

6. PROCEDURE FOR BENCH TESTS

6.1. Special conditions for carrying out the cycle

- 6.1.1. During the test, the test cell temperature must be between 293 K and 303 K (20 and 30 °C). The absolute humidity (H) of either the air in the test cell or the intake air of the engine shall be such that:

$$5.5 \leq H \leq 12.2 \quad (\text{g H}_2\text{O/kg dry air})$$

- 6.1.2. The vehicle shall be approximately horizontal during the test so as to avoid any abnormal distribution of the fuel.

- 6.1.3. A current of air of variable speed shall be blown over the vehicle. The blower speed shall be such that, within the operating range of 10 km/h to at least 50 km/h, the linear velocity of the air at the blower outlet is within ± 5 km/h of the corresponding roller speed. The final selection of the blower shall have the following characteristics:

Area: at least 0.2 m²;
Height of the lower edge above ground: approximately 20 cm;
Distance from the front of the vehicle: approximately 30 cm.

As an alternative the blower speed shall be fixed at an air speed of at least 6 m/s (21.6 km/h).

For special vehicles (e.g. vans, off-road), the height of the cooling fan can also be modified at the request of the manufacturer.

- 6.1.4. During the test the speed is recorded against time or collected by the data-acquisition system so that the correctness of the cycles performed can be assessed.

6.2. Starting-up the engine

- 6.2.1. The engine shall be started up by means of the devices provided for this purpose according to the manufacturer's instructions, as incorporated in the drivers' handbook of production vehicles.

6.2.2. The first cycle starts on the initiation of the engine start-up procedure.

6.2.3. In the case of the use of LPG or NG as a fuel it is permissible that the engine is started on petrol and switched to LPG or NG after a predetermined period of time which cannot be changed by the driver.

6.3. Idling

6.3.1. Manual-shift or semi-automatic gearbox, see Appendix 1 to this Annex, tables 1.2 and 1.3.

6.3.2. Automatic-shift gearbox

After initial engagement the selector shall not be operated at any time during the test except in the case specified in paragraph 6.4.3. below or if the selector can actuate the overdrive, if any.

6.4. Accelerations

6.4.1. Accelerations shall be so performed that the rate of acceleration is as constant as possible throughout the operation.

6.4.2. If an acceleration cannot be carried out in the prescribed time, the extra time required shall be deducted from the time allowed for changing gear, if possible, but otherwise from the subsequent steady-speed period.

6.4.3. Automatic-shift gearboxes

If an acceleration cannot be carried out in the prescribed time, the gear selector shall operate in accordance with requirements for manual-shift gearboxes.

6.5. Decelerations

6.5.1. All decelerations of the elementary urban cycle (Part One) shall be effected by removing the foot completely from the accelerator, the clutch remaining engaged. The clutch shall be disengaged, without use of the gear lever, at the higher of the following speeds: 10 km/h or the speed corresponding to the engine idle speed.

All decelerations of the extra-urban cycle (Part Two) shall be effected by removing the foot completely from the accelerator, the clutch remaining engaged. The clutch shall be disengaged, without use of the gear lever, at a speed of 50 km/h for the last deceleration.

- 6.5.2. If the period of deceleration is longer than that prescribed for the corresponding phase, the vehicle's brakes shall be used to enable the timing of the cycle to be complied with.
- 6.5.3. If the period of deceleration is shorter than that prescribed for the corresponding phase, the timing of the theoretical cycle shall be restored by constant speed or idling period merging into the following operation.
- 6.5.4. At the end of the deceleration period (halt of the vehicle on the rollers) of the elementary urban cycle (Part One) the gears shall be placed in neutral and the clutch engaged.
- 6.6. Steady speeds
- 6.6.1. "Pumping" or the closing of the throttle shall be avoided when passing from acceleration to the following steady speed.
- 6.6.2. Periods of constant speed shall be achieved by keeping the accelerator position fixed.
7. PROCEDURE FOR SAMPLING AND ANALYSIS
- 7.1. Sampling
- Sampling shall begin (BS) before or at the initiation of the engine start up procedure and end on conclusion of the final idling period in the extra-urban cycle (Part Two, end of sampling (ES)) or, in the case of test Type VI, on conclusion of the final idling period of the last elementary urban cycle (Part One).
- 7.2. Analysis
- 7.2.1. The exhaust gases contained in the bag shall be analysed as soon as possible and in any event not later than 20 minutes after the end of the test cycle. The spent particulate filters shall be taken to the chamber no later than one hour after conclusion of the test on the exhaust gases and shall there be conditioned for between 2 and 36 hours and then be weighed.
- 7.2.2. Prior to each sample analysis, the analyser range to be used for each pollutant shall be set to zero with the appropriate zero gas.
- 7.2.3. The analysers shall then be set to the calibration curves by means of span gases of nominal concentrations of 70 to 100 per cent of the range.

- 7.2.4. The analysers' zeros shall then be rechecked. If the reading differs by more than 2 per cent of the range from that set in paragraph 7.2.2. above, the procedure shall be repeated.
- 7.2.5. The samples shall then be analysed.
- 7.2.6. After the analysis, zero and span points shall be rechecked using the same gases. If these rechecks are within ± 2 per cent of those in paragraph 7.2.3. above, the analysis shall be considered acceptable.
- 7.2.7. At all points in this paragraph, the flow-rates and pressures of the various gases shall be the same as those used during calibration of the analysers.
- 7.2.8. The figure adopted for the content of the gases in each of the pollutants measured shall be that read off after stabilisation of the measuring device. Hydrocarbon mass emissions of compression-ignition engines shall be calculated from the integrated HFID reading, corrected for varying flow if necessary, as shown in Appendix 5 to this Annex.

8. DETERMINATION OF THE QUANTITY OF GASEOUS AND PARTICULATE POLLUTANTS EMITTED

8.1. The volume considered

The volume to be considered shall be corrected to conform to the conditions of 101.33 kPa and 273.2 K.

8.2. Total mass of gaseous and particulate pollutants emitted

The mass M of each pollutant emitted by the vehicle during the test shall be determined by obtaining the product of the volumetric concentration and the volume of the gas in question, with due regard for the following densities under above-mentioned reference conditions:

In the case of carbon monoxide (CO): $d = 1.25 \text{ g/l}$

In the case of hydrocarbons:

for petrol ($\text{CH}_{1.85}$) $d = 0.619 \text{ g/l}$

for diesel ($\text{CH}_{1.86}$) $d = 0.619 \text{ g/l}$

for LPG ($\text{CH}_{2.525}$) $d = 0.649 \text{ g/l}$

for NG (CH_4) $d = 0.714 \text{ g/l}$

In the case of nitrogen oxides (NO_x): $d = 2.05 \text{ g/l}$

The mass m of particulate pollutant emissions from the vehicle during the test shall be defined by weighing the mass of particulates collected by the two filters, m_1 by the first filter, m_2 by the second filter:

if $0.95 (m_1 + m_2) \leq m_1$, $m = m_1$,

if $0.95 (m_1 + m_2) > m_1$, $m = m_1 + m_2$,

if $m_2 > m_1$, the test is cancelled.

Appendix 8 to this Annex gives calculations, followed by examples, used to determine the mass emissions of gaseous and particulate pollutants.

Annex 4 - Appendix 1

BREAKDOWN OF THE OPERATING CYCLE USED FOR THE TYPE I TEST

1. OPERATING CYCLE

The operating cycle, made up of a Part One (urban cycle) and Part Two (extra-urban cycle), is illustrated in Figure 1/1.

2. ELEMENTARY URBAN CYCLE (Part One)

(See Figure 1/2 and Table 1.2.)

2.1. Breakdown by phases:

	Time (s)	per cent	
Idling	60	30.8	35.4
Idling, vehicle moving, clutch engaged on one combination	9	4.6	
Gear-changing	8	4.1	
Accelerations	36	18.5	
Steady-speed periods	57	29.2	
Decelerations	25	12.8	
	195	100	

2.2. Breakdown by use of gears:

	Time (s)	per cent	
Idling	60	30.8	35.4
Idling, vehicle moving, clutch engaged on one combination	9	4.6	
Gear-changing	8	4.1	
First gear	24	12.3	
Second gear	53	27.2	
Third gear	41	21	
	195	100	

2.3. General information:

Average speed during test :	19 km/h
Effective running time :	195 s
Theoretical distance covered per cycle :	1.013 km
Equivalent distance for the four cycles :	4.052 km

Figure 1/1

Operating cycle for the Type I test

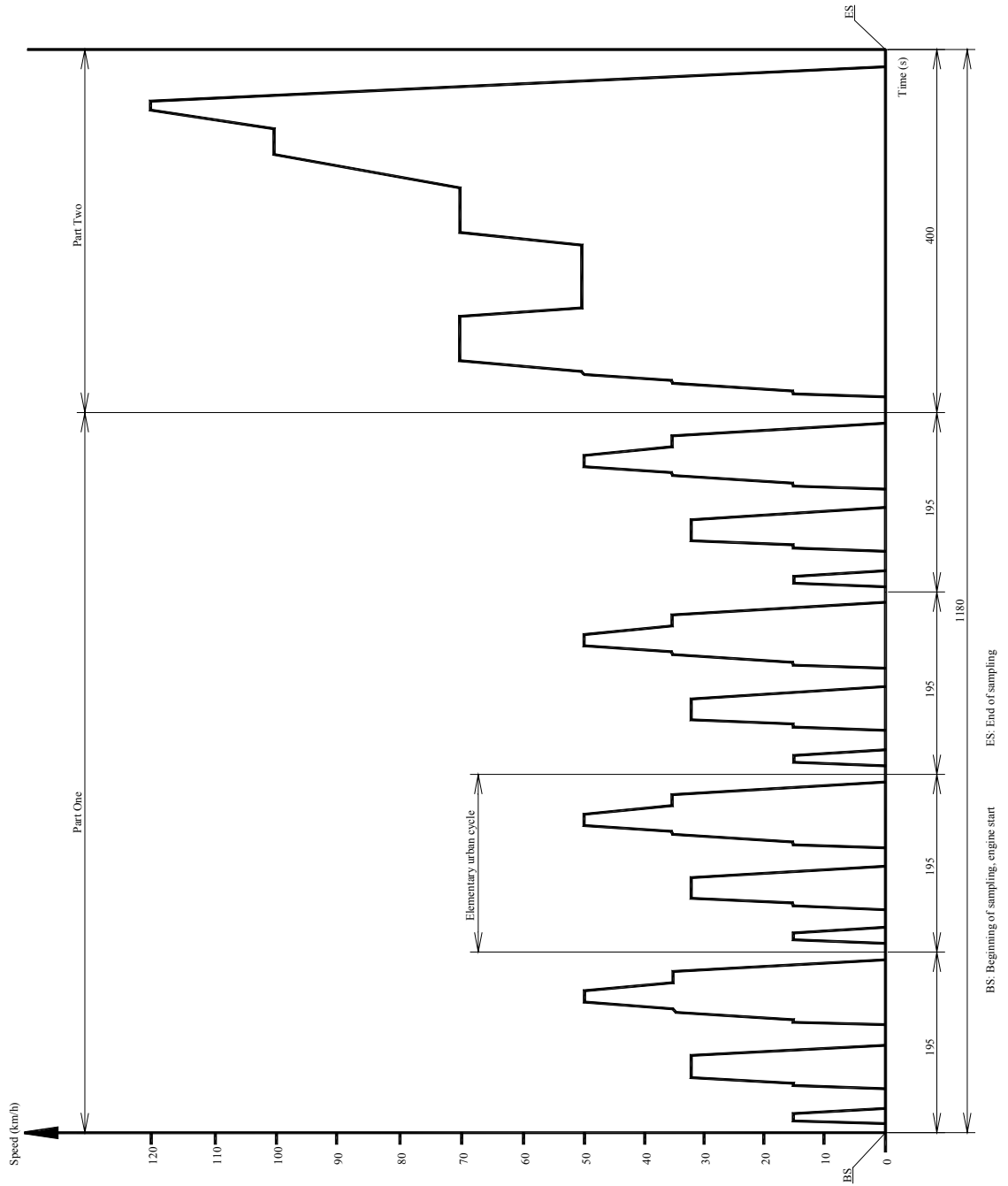

Table 1.2
Elementary urban operating cycle on the chassis dynamometer (Part One)

No. of operation	Operation	Phase	Acceleration (m/s ²)	Speed (km/h)	Duration of each		Cumulative time (s)	Gear to be used in the case of a manual gearbox
					Operation (s)	Phase (s)		
1	Idling	1			11	11	11	6 s PM + 5 s K ₁ (*)
2	Acceleration	2	1.04	0-15	4	4	15	1
3	Steady speed	3		15	9	8	23	1
4	Deceleration	4	-0.69	15-10	2	5	25	1
5	Deceleration, clutch disengaged		-0.92	10-0	3		28	K ₁ (*)
6	Idling	5			21	21	49	16 s PM + 5 s K ₁ (*)
7	Acceleration	6	0.83	0-15	5	12	54	1
8	Gear change				2		56	
9	Acceleration		0.94	15-32	5		61	2
10	Steady speed	7		32	24	24	85	2
11	Deceleration	8	-0.75	32-10	8	11	93	2
12	Deceleration, clutch disengaged		-0.92	10-0	3		96	K ₂ (*)
13	Idling	9	0-15	0-15	21		117	16 s PM + 5 s K ₁ (*)
14	Acceleration	10			5	26	122	1

No. of operation	Operation	Phase	Acceleration (m/s ²)	Speed (km/h)	Duration of each		Cumulative time (s)	Gear to be used in the case of a manual gearbox
					Operation (s)	Phase (s)		
15	Gear change				2		124	
16	Acceleration		0.62	15-35	9		133	2
17	Gear change				2		135	
18	Acceleration		0.52	35-50	8		143	3
19	Steady speed	11		50	12	12	155	3
20	Deceleration	12	-0.52	50-35	8	8	163	3
21	Steady speed	13		35	13	13	176	3
22	Gear change	14			2	12	178	
23	Deceleration		-0.99	35-10	7		185	2
24	Deceleration clutch disengaged		-0.92	10-0	3		188	K ₂ (*)
25	Idling	15			7	7	195	7 s PM (*)

(*) PM = gearbox in neutral, clutch engaged. K₁, K₂ = first or second gear engaged, clutch disengaged.

Figure 1/2
 Elementary urban cycle for the Type I test

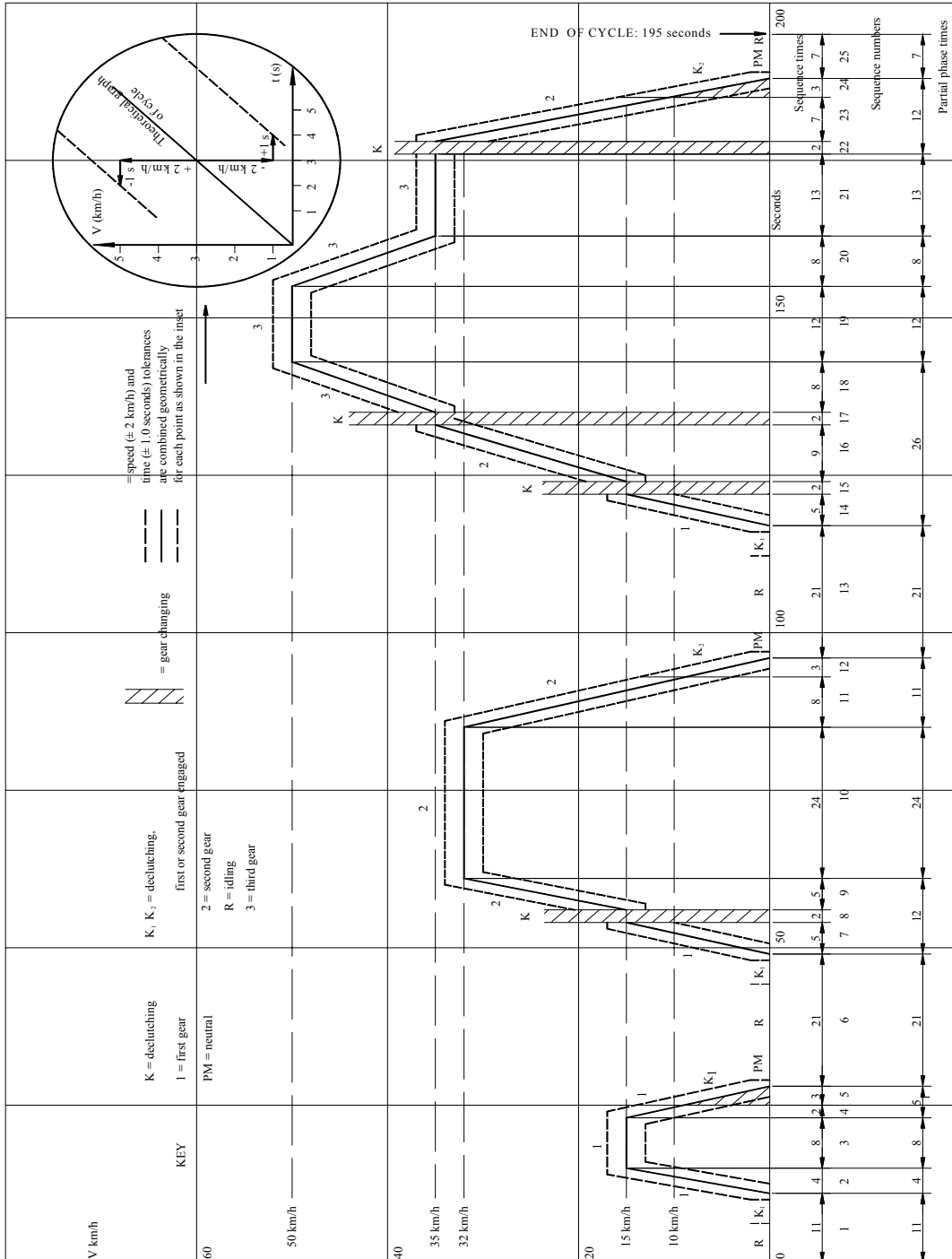

3. EXTRA-URBAN CYCLE (Part Two)

(See Figure 1/3 and Table 1.3.)

3.1. Breakdown by phases:

	Time (s)	per cent
Idling:	20	5.0
Idling, vehicle moving, clutch engaged on one combination:	20	5.0
Gear-shift:	6	1.5
Accelerations:	103	25.8
Steady-speed periods:	209	52.2
Decelerations:	42	10.5
	400	100

3.2. Breakdown by use of gears:

	Time (s)	per cent
Idling:	20	5.0
Idling, vehicle moving, clutch engaged on one combination:	20	5.0
Gear-shift:	6	1.5
First gear:	5	1.3
Second-gear	9	2.2
Third gear:	8	2
Fourth gear:	99	24.8
Fifth gear:	233	58.2
	400	100

3.3. General information

Average speed during test:	62.6 km/h
Effective running time:	400 s
Theoretical distance covered per cycle:	6.955 km
Maximum speed:	120 km/h
Maximum acceleration:	0.833 m/s ²
Maximum deceleration:	-1.389 m/s ²

Table 1.3

Extra-urban cycle (Part Two) for the Type I test

No. of operation	Operation	Phase	Acceleration (m/s ²)	Speed (km/h)	Duration of each		Cumulative time (s)	Gear to be used in the case of a manual gearbox
					Operation (s)	Phase (s)		
1	Idling	1			20	20	20	K ₁ (1)
2	Acceleration	12	0.83	0	5	41	25	1
3	Gear change				2		27	-
4	Acceleration		0.62	15-35	9		36	2
5	Gear change				2		38	-
6	Acceleration		0.52	35-30	8		46	3
7	Gear change				2		48	-
8	Acceleration		0.43	50-70	13		61	4
9	Steady speed		3		70		50	50
10	Deceleration	4	-0.69	70-50	8	8	119	4 s.5 + 4 s.4
11	Steady speed	5		50	69	69	188	4
12	Acceleration	6	0.43	50-70	13	13	201	4
13	Steady speed	7		70	50	50	251	5

No. of operation	Operation	Phase	Acceleration (m/s ²)	Speed (km/h)	Duration of each		Cumulative time (s)	Gear to be used in the case of a manual gearbox
					Operation (s)	Phase (s)		
14	Acceleration	8	0.24	70-100	35	35	286	5
15	Steady speed (2)	9		100	30	30	316	5 (2)
16	Acceleration (2)	10	0.28	100-120	20	20	336	5 (2)
17	Steady speed (2)	11		120	10	20	346	5 (2)
18	Deceleration (2)	12	-0.69	120-80	16	34	362	5 (2)
19	Deceleration (2)		-1.04	80-50	8		370	5 (2)
20	Deceleration, clutch disengaged		1.39	50-0	10		380	K5 (1)
21	Idle	13			20	20	400	PM (1)

- (1) PM = gearbox on neutral, clutch engaged.
K₁,K₅ = first or fifth gear engaged, clutch disengaged
- (2) Additional gears can be used according to manufacturer recommendations if the vehicle is equipped with a transmission with more than five gears.

Figure 1/3

Extra-urban cycle (Part Two) for the Type I test

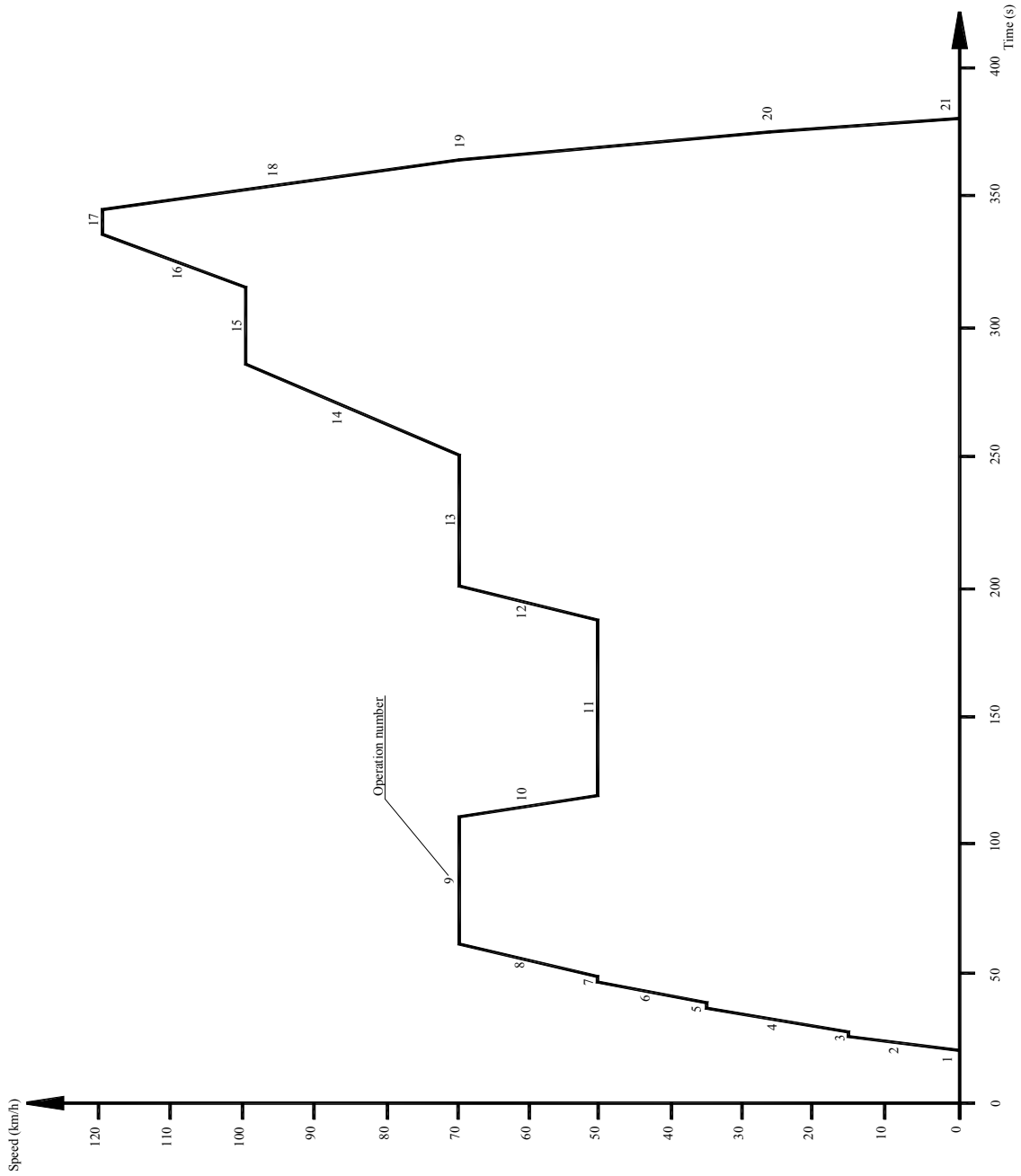

Annex 4 - Appendix 2

CHASSIS DYNAMOMETER

1. DEFINITION OF A CHASSIS DYNAMOMETER WITH FIXED LOAD CURVE

1.1. Introduction

In the event that the total resistance to progress on the road cannot be reproduced on the chassis dynamometer between speeds of 10 km/h and 120 km/h, it is recommended that a chassis dynamometer having the characteristics defined below should be used.

1.2. Definition

1.2.1. The chassis dynamometer may have one or two rollers.
The front roller shall drive, directly or indirectly, the inertial masses and the power absorption device.

1.2.2. The load absorbed by the brake and the chassis dynamometer internal frictional effects between the speeds of 0 and 120 km/h is as follows:

$$F = (a + b.V^2) \pm 0.1.F_{80} \quad (\text{without being negative})$$

where:

- F = total load absorbed by the chassis dynamometer (N)
a = value equivalent to rolling resistance (N)
b = value equivalent to coefficient of air resistance (N/(km/h)²)
V = speed (km/h)
F₈₀ = load at 80 km/h (N).

2. METHOD OF CALIBRATING THE DYNAMOMETER

2.1. Introduction

This Appendix describes the method to be used to determine the load absorbed by a dynamometer brake. The load absorbed comprises the load absorbed by frictional effects and the load absorbed by the power-absorption device.

The dynamometer is brought into operation beyond the range of test speeds. The device used for starting up the dynamometer is then disconnected: the rotational speed of the driven roller decreases.

The kinetic energy of the rollers is dissipated by the power-absorption unit and by the frictional effects. This method disregards variations in the roller's internal frictional effects caused by rollers with or without the vehicle. The frictional effects of the rear roller shall be disregarded when the roller is free.

2.2. Calibration of the load indicator to 80 km/h as a function of the load absorbed.

The following procedure shall be used (see also Figure 2/1):

- 2.2.1. Measure the rotational speed of the roller if this has not already been done. A fifth wheel, a revolution counter or some other method may be used.
- 2.2.2. Place the vehicle on the dynamometer or devise some other method of starting-up the dynamometer.
- 2.2.3. Use the flywheel or any other system of inertia simulation for the particular inertia class to be used.

Figure 2/1

Diagram illustrating the power absorbed by the chassis dynamometer

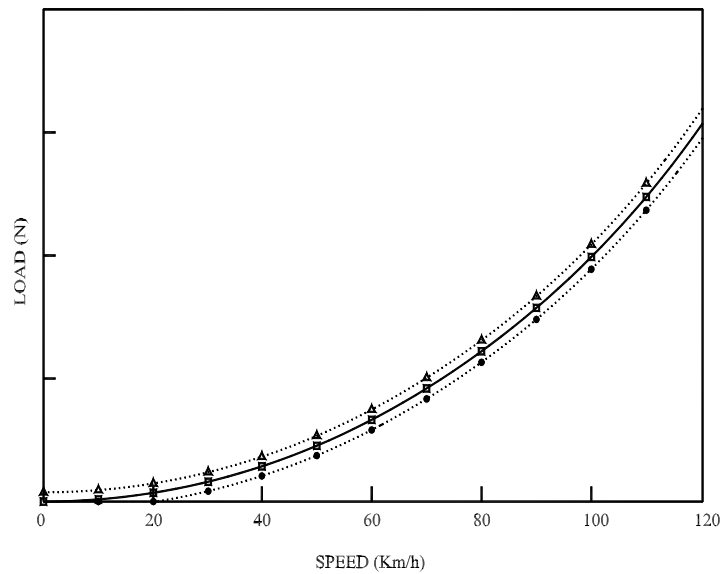

$$\square = F = a + b \cdot V^2 \quad \bullet = (a + b \cdot V^2) - 0.1 \cdot F_{80} \quad \Delta = (a + b \cdot V^2) + 0.1 \cdot F_{80}$$

- 2.2.4. Bring the dynamometer to a speed of 80 km/h.
- 2.2.5. Note the load indicated F_i (N)
- 2.2.6. Bring the dynamometer to a speed of 90 km/h.
- 2.2.7. Disconnect the device used to start-up the dynamometer.
- 2.2.8. Note the time taken by the dynamometer to pass from a speed of 85 km/h to a speed of 75 km/h.
- 2.2.9. Set the power-absorption device at a different level.
- 2.2.10. The requirements of paragraphs 2.2.4. to 2.2.9. shall be repeated sufficiently often to cover the range of loads used.
- 2.2.11. Calculate the load absorbed using the formula:

$$F = \frac{M_i \cdot \Delta V}{t}$$

where:

- F = load absorbed (N)
- M_i = equivalent inertia in kg (excluding the inertial effects of the free rear roller)
- ΔV = Speed deviation in m/s (10 km/h = 2.775 m/s)
- t = time taken by the roller to pass from 85 km/h to 75 km/h.

- 2.2.12. Figure 2/2 shows the load indicated at 80 km/h in terms of load absorbed at 80 km/h.

Figure 2/2

Load indicated at 80 km/h in terms of load absorbed at 80 km/h

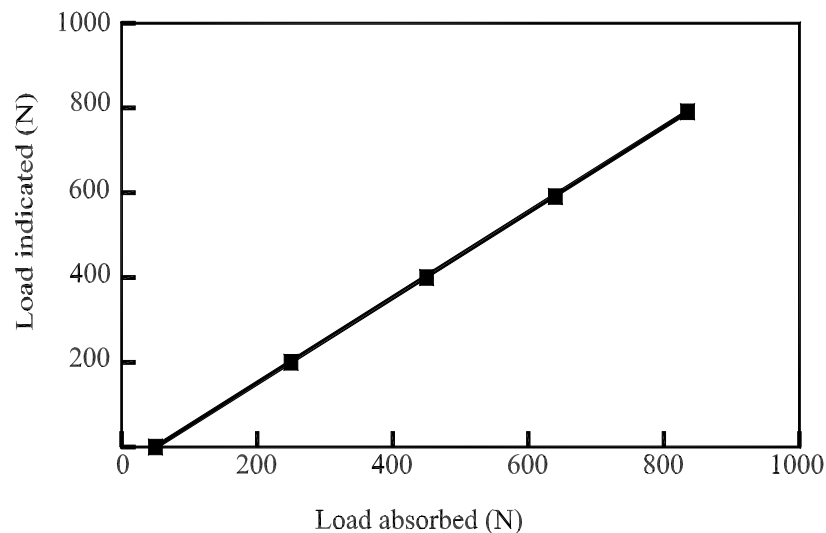

- 2.2.13. The requirements of paragraphs 2.2.3. to 2.2.12. above shall be repeated for all inertia classes to be used.
- 2.3. Calibration of the load indicator as a function of the absorbed load for other speeds. The procedures described in paragraph 2.2. above shall be repeated as often as necessary for the chosen speeds.
- 2.4. Verification of the load-absorption curve of the dynamometer from a reference setting at a speed of 80 km/h.
 - 2.4.1. Place the vehicle on the dynamometer or devise some other method of starting-up the dynamometer.
 - 2.4.2. Adjust the dynamometer to the absorbed load (F) at 80 km/h.
 - 2.4.3. Note the load absorbed at 120, 100, 80, 60, 40 and 20 km/h.
 - 2.4.4. Draw the curve F(V) and verify that it corresponds to the requirements of paragraph 1.2.2. of this Appendix.
 - 2.4.5. Repeat the procedure set out in paragraphs 2.4.1. to 2.4.4. above for other values of power F at 80 km/h and for other values of inertias.

2.5. The same procedure shall be used for force or torque calibration.

3. SETTING OF THE DYNAMOMETER

3.1. Setting method

3.1.1. Introduction

This method is not a preferred method and shall be used only with fixed load curve shape dynamometers for determination of load setting at 80 km/h and cannot be used for vehicles with compression-ignition engines.

3.1.2. Test instrumentation

The vacuum (or absolute pressure) in the vehicle's intake manifold shall be measured to an accuracy of ± 0.25 kPa. It shall be possible to record this reading continuously or at intervals of no more than one second. The speed shall be recorded continuously with a precision of ± 0.4 km/h.

3.1.3. Road test

3.1.3.1. Ensure that the requirements of paragraph 4. of Appendix 3 to this Annex are met.

3.1.3.2. Drive the vehicle at a steady speed of 80 km/h, recording speed and vacuum (or absolute pressure) in accordance with the requirements of paragraph 3.1.2. above.

3.1.3.3. Repeat procedure set out in paragraph 3.1.3.2. above three times in each direction. All six runs must be completed within four hours.

3.1.4. Data reduction and acceptance criteria

3.1.4.1. Review results obtained in accordance with paragraphs 3.1.3.2. and 3.1.3.3. above. (Speed must not be lower than 79.5 km/h or greater than 80.5 km/h for more than one second). For each run, read vacuum level at one second intervals, calculate mean vacuum (\bar{v}) and standard deviation (s). This calculation shall consist of no less than 10 readings of vacuum.

3.1.4.2. The standard deviation must not exceed 10 per cent of the mean (\bar{v}) for each run.

3.1.4.3. Calculate the mean value (\bar{v}) for the six runs (three runs in each direction).

3.1.5. Dynamometer setting

3.1.5.1. Preparation

Perform the operations specified in paragraphs 5.1.2.2.1. to 5.1.2.2.4. of Appendix 3 to this Annex.

3.1.5.2. Load setting

After warm-up, drive the vehicle at a steady speed of 80 km/h and adjust dynamometer load to reproduce the vacuum reading (\bar{v}) obtained in accordance with paragraph 3.1.4.3. above. Deviation from this reading shall be no greater than 0.25 kPa. The same instruments shall be used for this exercise as were used during the road test.

3.2. Alternative method

With the manufacturer's agreement the following method may be used.

3.2.1. The brake is adjusted so as to absorb the load exerted at the driving wheels at a constant speed of 80 km/h, in accordance with the following table:

Reference mass of vehicle Rm (kg)	Equivalent inertia kg	Power and load absorbed by the dynamometer at 80 km/h		Coefficients	
		kW	N	a N	b N/(km/h)
Rm ≤ 480	455	3.8	171	3.8	0.0261
480 < Rm ≤ 540	510	4.1	185	4.2	0.0282
540 < Rm ≤ 595	570	4.3	194	4.4	0.0296
595 < Rm ≤ 650	625	4.5	203	4.6	0.0309
650 < Rm ≤ 710	680	4.7	212	4.8	0.0323
710 < Rm ≤ 765	740	4.9	221	5.0	0.0337
765 < Rm ≤ 850	800	5.1	230	5.2	0.0351
850 < Rm ≤ 965	910	5.6	252	5.7	0.0385
965 < Rm ≤ 1080	1020	6.0	270	6.1	0.0412
1080 < Rm ≤ 1190	1130	6.3	284	6.4	0.0433
1190 < Rm ≤ 1305	1250	6.7	302	6.8	0.0460
1305 < Rm ≤ 1420	1360	7.0	315	7.1	0.0481
1420 < Rm ≤ 1530	1470	7.3	329	7.4	0.0502
1530 < Rm ≤ 1640	1590	7.5	338	7.6	0.0515
1640 < Rm ≤ 1760	1700	7.8	351	7.9	0.0536
1760 < Rm ≤ 1870	1810	8.1	365	8.2	0.0557
1870 < Rm ≤ 1980	1930	8.4	378	8.5	0.0577
1980 < Rm ≤ 2100	2040	8.6	387	8.7	0.0591
2100 < Rm ≤ 2210	2150	8.8	396	8.9	0.0605
2210 < Rm ≤ 2380	2270	9.0	405	9.1	0.0619
2380 < Rm ≤ 2610	2270	9.4	423	9.5	0.0646
2610 < Rm	2270	9.8	441	9.9	0.0674

3.2.2. In the case of vehicles other than passenger cars, with a reference mass of more than 1,700 kg or vehicles with permanent all-wheel drive, the power values given in the table set out in paragraph 3.2.1. above are multiplied by the factor 1.3.

Annex 4 - Appendix 3

RESISTANCE TO PROGRESS OF A VEHICLE MEASUREMENT METHOD ON THE ROAD SIMULATION ON A CHASSIS DYNAMOMETER

1. OBJECT OF THE METHODS

The object of the methods defined below is to measure the resistance to progress of a vehicle at stabilised speeds on the road and to simulate this resistance on a dynamometer, in accordance with the conditions set out in paragraph 4.1.5. of Annex 4.

2. DEFINITION OF THE ROAD

The road shall be level and sufficiently long to enable the measurements specified below to be made. The slope shall be constant to within ± 0.1 per cent and shall not exceed 1.5 per cent.

3. ATMOSPHERIC CONDITIONS

3.1. Wind

Testing shall be limited to wind speeds averaging less than 3 m/s with peak speeds of less than 5 m/s. In addition, the vector component of the wind speed across the test road shall be less than 2 m/s. Wind velocity shall be measured 0.7 m above the road surface.

3.2. Humidity

The road shall be dry.

3.3. Pressure - Temperature

Air density at the time of the test shall not deviate by more than ± 7.5 per cent from the reference conditions, $P = 100$ kPa and $T = 293.2$ K.

4. VEHICLE PREPARATION 1/

4.1. Selection of the test vehicle

1/ For HEV, and until uniform technical provisions have been established, the manufacturer will agree with the technical service concerning the status of the vehicle when performing the test as defined in this appendix.

If not all variants of a vehicle type are measured, the following criteria for the selection of the test vehicle shall be used.

4.1.1. Body

If there are different types of body, the test shall be performed on the least aerodynamic body. The manufacturer shall provide the necessary data for the selection.

4.1.2. Tyres

The widest tyre shall be chosen. If there are more than three tyre sizes, the widest minus one shall be chosen.

4.1.3. Testing mass

The testing mass shall be the reference mass of the vehicle with the highest inertia range.

4.1.4. Engine

The test vehicle shall have the largest heat exchanger(s).

4.1.5. Transmission

A test shall be carried out with each type of the following transmission:

- front-wheel drive
- rear-wheel drive
- full-time 4 x 4
- part-time 4 x 4
- automatic gearbox
- manual gearbox

4.2. Running-in

The vehicle shall be in normal running order and adjustment after having been run-in for at least 3,000/km. The tyres shall be run-in at the same time as the vehicle or have a tread depth within 90 and 50 per cent of the initial tread depth.

4.3. Verifications

The following checks shall be made in accordance with the manufacturer's specifications for the use considered:

wheels, wheel trims, tyres (make, type, pressure),
front axle geometry,
brake adjustment (elimination of parasitic drag), lubrication of front and rear axles,
adjustment of the suspension and vehicle level, etc.

4.4. Preparation for the test

4.4.1. The vehicle shall be loaded to its reference mass. The level of the vehicle shall be that obtained when the centre of gravity of the load is situated midway between the 'R' points of the front outer seats and on a straight line passing through those points.

4.4.2. In the case of road tests, the windows of the vehicle shall be closed. Any covers of air climatisation systems, headlamps, etc. shall be in the non-operating position.

4.4.3. The vehicle shall be clean.

4.4.4. Immediately prior to the test, the vehicle shall be brought to normal running temperature in an appropriate manner.

5. METHODS

5.1. Energy variation during coast-down method

5.1.1. On the road

5.1.1.1. Test equipment and error

Time shall be measured to an error lower than ± 0.1 s.
Speed shall be measured to an error lower than ± 2 per cent.

5.1.1.2. Test procedure

5.1.1.2.1. Accelerate the vehicle to a speed 10 km/h greater than the chosen test speed V.

5.1.1.2.2. Place the gearbox in 'neutral' position

5.1.1.2.3. Measure the time taken (t_1) for the vehicle to decelerate from speed

$$V_2 = V + \Delta V \text{ km/h to } V_1 = V - \Delta V \text{ km/h}$$

5.1.1.2.4. Perform the same test in the opposite direction: t_2

5.1.1.2.5. Take the average T of the two times $t_1 - t_2$

5.1.1.2.6. Repeat these tests several times such that the statistical accuracy (p) of the average

$$T = \frac{1}{n} \sum_{i=1}^n T_i \text{ is not more than 2 per cent } (p \leq 2 \text{ per cent})$$

The statistical accuracy (p) is defined by:

$$p = \left(\frac{t \cdot s}{\sqrt{n}} \right) \cdot \frac{100}{T}$$

where:

t = coefficient given by the table below,

n = number of tests,

s = standard deviation,

$$s = \sqrt{\frac{\sum_{i=1}^n (T_i - T)^2}{n - 1}}$$

n	4	5	6	7	8	9	10	11	12	13	14	15
t	3.2	2.8	2.6	2.5	2.4	2.3	2.3	2.2	2.2	2.2	2.2	2.2
$\frac{t}{\sqrt{n}}$	1.6	1.25	1.06	0.94	0.85	0.77	0.73	0.66	0.64	0.61	0.59	0.57

5.1.1.2.7. Calculate the power by the formula:

$$P = \frac{M \cdot V \cdot \Delta V}{T}$$

where:

P is expressed in kW,

V = speed of the test in m/s,

ΔV = speed deviation from speed V , in m/s.

M = reference mass in kg,

T = time in seconds (s).

5.1.1.2.8. The power (P) determined on the track shall be corrected to the reference ambient conditions as follows:

$$P_{\text{Corrected}} = K \cdot P_{\text{Measured}}$$

$$K = \frac{R_R}{R_T} \cdot [1 + K_R (t - t_0)] + \frac{R_{\text{AERO}}}{R_T} \cdot \frac{(\rho_0)}{\rho}$$

where:

- R_R = rolling resistance at speed V
- R_{AERO} = aerodynamic drag at speed V
- R_T = total driving resistance = $R_R + R_{\text{AERO}}$
- K_R = temperature correction factor of rolling resistance, taken to be equal to: $8.64 \times 10^{-3}/^{\circ}\text{C}$, or the manufacturer's correction factor that is approved by the authority
- t = road test ambient temperature in $^{\circ}\text{C}$
- t_0 = reference ambient temperature = 20°C
- ρ = air density at the test conditions
- ρ_0 = air density at the reference conditions (20°C , 100 kPa)

The ratios R_R/R_T and R_{AERO}/R_T shall be specified by the vehicle manufacturer based on the data normally available to the company.

If these values are not available, subject to the agreement of the manufacturer and the technical service concerned, the figures for the rolling/ total resistance given by the following formula may be used:

$$\frac{R_R}{R_T} = a \cdot M + b$$

where:

M = vehicle mass in kg,

and for each speed the coefficients a and b are shown in the following table:

V (km/h)	a	b
20	$7.24 \text{ A } 10^{-5}$	0.82
40	$1.59 \text{ A } 10^{-4}$	0.54
60	$1.96 \text{ A } 10^{-4}$	0.33
80	$1.85 \text{ A } 10^{-4}$	0.23
100	$1.63 \text{ A } 10^{-4}$	0.18
120	$1.57 \text{ A } 10^{-4}$	0.14

5.1.2. On the dynamometer

5.1.2.1. Measurement equipment and accuracy

The equipment shall be identical to that used on the road.

5.1.2.2. Test procedure

5.1.2.2.1. Install the vehicle on the test dynamometer.

5.1.2.2.2. Adjust the tyre pressure (cold) of the driving wheels as required by the dynamometer.

5.1.2.2.3. Adjust the equivalent inertia of the dynamometer.

5.1.2.2.4. Bring the vehicle and dynamometer to operating temperature in a suitable manner.

5.1.2.2.5. Carry out the operations specified in paragraph 5.1.1.2. above (with the exception of paragraphs 5.1.1.2.4. and 5.1.1.2.5.), replacing M by I in the formula set out in paragraph 5.1.1.2.7.

5.1.2.2.6. Adjust the brake to reproduce the corrected power (paragraph 5.1.1.2.8.) and to take into account the difference between the vehicle mass (M) on the track and the equivalent inertia test mass (I) to be used. This may be done by calculating the mean corrected road coast down time from V_2 to V_1 and reproducing the same time on the dynamometer by the following relationship:

$$T_{\text{corrected}} = \frac{T_{\text{measured}}}{K} \cdot \frac{I}{M}$$

k = value specified in paragraph 5.1.1.2.8. above.

5.1.2.2.7. The power P_a to be absorbed by the dynamometer shall be determined in order to enable the same power (paragraph 5.1.1.2.8.) to be reproduced for the same vehicle on different days.

5.2. Torque measurements method at constant speed

5.2.1. On the road

5.2.1.1. Measurement equipment and error

Torque measurement shall be carried out with an appropriate measuring device accurate to within ± 2 per cent.

Speed measurement shall be accurate to within ± 2 per cent.

5.2.1.2. Test procedure

5.2.1.2.1. Bring the vehicle to the chosen stabilised speed V.

5.2.1.2.2. Record the torque C_t and speed over a period of at least 20 seconds. The accuracy of the data recording system shall be at least ± 1 Nm for the torque and ± 0.2 km/h for the speed.

5.2.1.2.3. Differences in torque C_t and speed relative to time shall not exceed 5 per cent for each second of the measurement period.

5.2.1.2.4. The torque C_{t1} is the average torque derived from the following formula:

$$C_{t1} = \frac{1}{\Delta t} \int_t^{t+\Delta t} C(t) dt$$

5.2.1.2.5. The test shall be carried out three times in each direction. Determine the average torque from these six measurements for the reference speed. If the average speed deviates by more than 1 km/h from the reference speed, a linear regression shall be used for calculating the average torque.

5.2.1.2.6. Determine the average of these two torques C_{t1} and C_{t2} , i.e. C_t .

5.2.1.2.7. The average torque C_T determined on the track shall be corrected to the reference ambient conditions as follows:

$$C_{Tcorrected} = K \cdot C_{Tmeasured}$$

where K has the value specified in paragraph 5.1.1.2.8. of this Appendix.

5.2.2. On the dynamometer

5.2.2.1. Measurement equipment and error

The equipment shall be identical to that used on the road.

5.2.2.2. Test procedure

5.2.2.2.1. Perform the operations specified in paragraphs 5.1.2.2.1. to 5.1.2.2.4. above.

5.2.2.2.2. Perform the operations specified in paragraphs 5.2.1.2.1. to 5.2.1.2.4. above.

5.2.2.2.3. Adjust the power absorption unit to reproduce the corrected total track torque indicated in paragraph 5.2.1.2.7. above.

5.2.2.2.4. Proceed with the same operations as in paragraph 5.1.2.2.7., for the same purpose.

Annex 4 - Appendix 4

VERIFICATION OF INERTIAS OTHER THAN MECHANICAL

1. OBJECT

The method described in this Appendix makes it possible to check that the simulated total inertia of the dynamometer is carried out satisfactorily in the running phase of the operating cycle. The manufacturer of the dynamometer shall specify a method for verifying the specifications according to paragraph 3. below.

2. PRINCIPLE

2.1. Drawing-up working equations

Since the dynamometer is subjected to variations in the rotating speed of the roller(s), the force at the surface of the roller(s) can be expressed by the formula:

$$F = I.\gamma = I_M .\gamma + F_1$$

where:

F = force at the surface of the roller(s),

I = total inertia of the dynamometer (equivalent inertia of the vehicle: see the table in paragraph 5.1.),

I_M = inertia of the mechanical masses of the dynamometer,

γ = tangential acceleration at roller surface,

F_1 = inertia force.

Note: An explanation of this formula with reference to dynamometers with mechanically simulated inertias is appended.

Thus, total inertia is expressed as follows:

$$I = I_m + F_1 / \gamma$$

where:

I_m can be calculated or measured by traditional methods,

F_1 can be measured on the dynamometer,

γ can be calculated from the peripheral speed of the rollers.

The total inertia (I) will be determined during an acceleration or deceleration test with values higher than or equal to those obtained on an operating cycle.

2.2. Specification for the calculation of total inertia

The test and calculation methods shall make it possible to determine the total inertia I with a relative error ($\Delta I/I$) of less than ± 2 per cent.

3. SPECIFICATION

3.1. The mass of the simulated total inertia I shall remain the same as the theoretical value of the equivalent inertia (see paragraph 5.1. of Annex 4) within the following limits:

3.1.1. ± 5 per cent of the theoretical value for each instantaneous value;

3.1.2. ± 2 per cent of the theoretical value for the average value calculated for each sequence of the cycle.

3.2. The limit given in paragraph 3.1.1. above is brought to ± 50 per cent for one second when starting and, for vehicles with manual transmission, for two seconds during gear changes.

4. VERIFICATION PROCEDURE

4.1. Verification is carried out during each test throughout the cycle defined in paragraph 2.1. of Annex 4.

4.2. However, if the requirements of paragraph 3. above are met, with instantaneous accelerations which are at least three times greater or smaller than the values obtained in the sequences of the theoretical cycle, the verification described above will not be necessary.

Annex 4 - Appendix 5

DEFINITION OF GAS-SAMPLING SYSTEMS

1. INTRODUCTION

- 1.1. There are several types of sampling devices capable of meeting the requirements set out in paragraph 4.2. of Annex 4.
The devices described in paragraphs 3.1. and 3.2. below shall be deemed acceptable if they satisfy the main criteria relating to the variable dilution principle.
- 1.2. In its communications, the laboratory shall mention the system of sampling used when performing the test.

2. CRITERIA RELATING TO THE VARIABLE-DILUTION SYSTEM FOR MEASURING EXHAUST-GAS EMISSIONS

2.1. Scope

This section shall specify the operating characteristics of an exhaust-gas sampling system intended to be used for measuring the true mass emissions of a vehicle exhaust in accordance with the provisions of this Regulation.

The principle of variable-dilution sampling for measuring mass emissions shall require three conditions to be satisfied:

- 2.1.1. The vehicle exhaust gases shall be continuously diluted with ambient air under specified conditions;
- 2.1.2. The total volume of the mixture of exhaust gases and dilution air shall be measured accurately;
- 2.1.3. A continuously proportional sample of the diluted exhaust gases and the dilution air shall be collected for analysis.

Mass gaseous emissions shall be determined from the proportional sample concentrations and the total volume measured during the test. The sample concentrations shall be corrected to take account of the pollutant content of the ambient air.

In addition, where vehicles are equipped with compression-ignition engines, their particulate emissions shall be plotted.

2.2. Technical summary

Figure 5/1 gives a schematic diagram of the sampling system.

- 2.2.1.1. The vehicle exhaust gases shall be diluted with a sufficient amount of ambient air to prevent any water condensation in the sampling and measuring system.
- 2.2.2. The exhaust-gas sampling system shall be so designed as to make it possible to measure the average volume concentrations of the CO₂, CO, HC and NO_x, and, in addition, in the case of vehicles equipped with compression-ignition engines, of the particulate emissions, contained in the exhaust gases emitted during the vehicle testing cycle.
- 2.2.3. The mixture of air and exhaust gases shall be homogeneous at the point where the sampling probe is located (see paragraph 2.3.1.2. below).
- 2.2.4. The probe shall extract a representative sample of the diluted gases.
- 2.2.5. The system shall enable the total volume of the diluted exhaust gases to be measured.
- 2.2.6. The sampling system shall be gas-tight. The design of the variable-dilution sampling system and the materials that go to make it up shall be such that they do not affect the pollutant concentration in the diluted exhaust gases. Should any component in the system (heat exchanger, cyclone separator, blower, etc.) change the concentration of any of the pollutants in the diluted exhaust gases and the fault cannot be corrected, then sampling for that pollutant shall be carried out upstream from that component.
- 2.2.7. If the vehicle tested is equipped with an exhaust system with several outlets, the connecting tubes shall be connected by a manifold installed as near as possible to the vehicle.
- 2.2.8. The gas samples shall be collected in sampling bags of adequate capacity so as not to hinder the gas flow during the sampling period. These bags shall be made of materials which will not affect the concentration of pollutant gases (see paragraph 2.3.4.4. below).
- 2.2.9. The variable-dilution system shall be so designed as to enable the exhaust gases to be sampled without appreciably changing the back-pressure at the exhaust pipe outlet (see paragraph 2.3.1.1. below).

Figure 5/1

Diagram of a variable-dilution system for measuring exhaust gas emissions

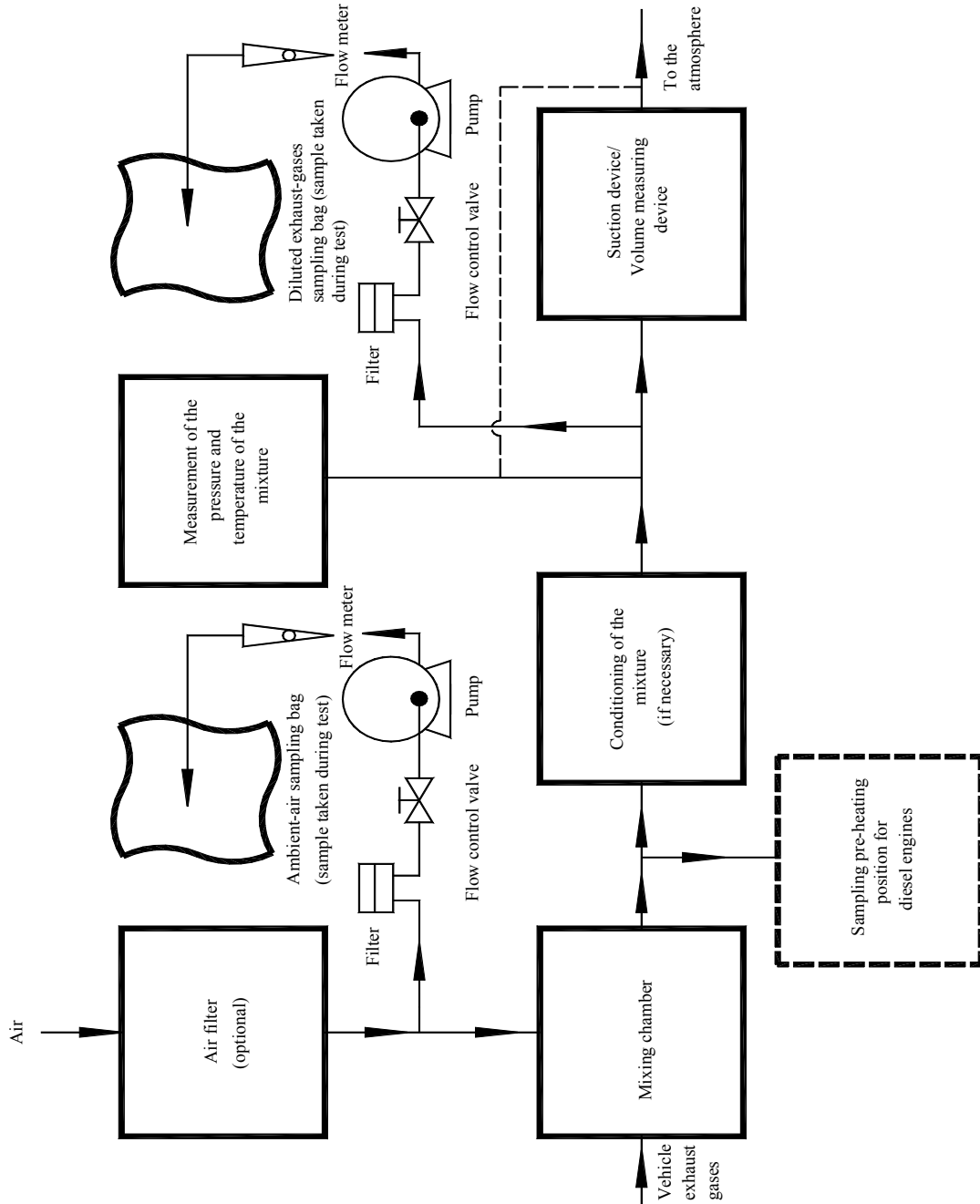

2.3. Specific requirements

2.3.1. Exhaust-gas collection and dilution device

2.3.1.1. The connecting tube between the vehicle exhaust outlets and the mixing chamber shall be as short as possible; it shall in no event:

- (i) cause the static pressure at the exhaust outlets on the vehicle being tested to differ by more than ± 0.75 kPa at 50 km/h or more than ± 1.25 kPa for the whole duration of the test from the static pressures recorded when nothing is connected to the vehicle exhaust outlets. The pressure shall be measured in the exhaust outlet or in an extension having the same diameter, as near as possible to the end of the pipe;
- (ii) change the nature of the exhaust gas.

2.3.1.2. Provision shall be made for a mixing chamber in which the vehicle exhaust gases and the dilution air are mixed so as to produce a homogeneous mixture at the chamber outlet.

The homogeneity of the mixture in any cross-section at the location of the sampling probe shall not vary by more than ± 2 per cent from the average of the values obtained for at least five points located at equal intervals on the diameter of the gas stream. In order to minimise the effects on the conditions at the exhaust outlet and to limit the drop in pressure inside the dilution-air conditioning device, if any, the pressure inside the mixing chamber shall not differ by more than ± 0.25 kPa from atmospheric pressure.

2.3.2. Suction device/volume measuring device

This device may have a range of fixed speeds as to ensure sufficient flow to prevent any water condensation. This result is generally obtained by keeping the concentration of CO₂ in the dilute exhaust gas sampling bag lower than 3 per cent by volume.

2.3.3. Volume measurement

2.3.3.1. The volume measuring device shall retain its calibration accuracy to within ± 2 per cent under all operating conditions. If the device cannot compensate for variations in the temperature of the mixture of exhaust gases and dilution air at the measuring point, a heat exchanger shall be used to maintain the temperature to within ± 6 K of the specified operating temperature.

If necessary, a cyclone separator may be used to protect the volume measuring device.

- 2.3.3.2. A temperature sensor shall be installed immediately before the volume measuring device. This temperature sensor shall have an accuracy and a precision of ± 1 K and a response time of 0.1 s at 62 per cent of a given temperature variation (value measured in silicone oil).
- 2.3.3.3. The pressure measurements shall have a precision and an accuracy of ± 0.4 kPa during the test.
- 2.3.3.4. The measurement of the pressure difference from atmospheric pressure shall be taken upstream from and, if necessary, downstream from the volume measuring device.
- 2.3.4. Gas sampling
 - 2.3.4.1. Dilute exhaust gases
 - 2.3.4.1.1. The sample of dilute exhaust gases shall be taken upstream from the suction device but downstream from the conditioning devices (if any).
 - 2.3.4.1.2. The flow rate shall not deviate from the average by more than ± 2 per cent.
 - 2.3.4.1.3. The sampling rate shall not fall below 5 litres per minute and shall not exceed 0.2 per cent of the flow rate of the dilute exhaust gases.
 - 2.3.4.2. Dilution air
 - 2.3.4.2.1. A sample of the dilution air shall be taken at a constant flow rate near the ambient air-inlet (after the filter if one is fitted).
 - 2.3.4.2.2. The air shall not be contaminated by exhaust gases from the mixing area.
 - 2.3.4.2.3. The sampling rate for the dilution air shall be comparable to that used in the case of the dilute exhaust gases.
 - 2.3.4.3. Sampling operations
 - 2.3.4.3.1. The materials used for the sampling operations shall be such as not to change the pollutant concentration.
 - 2.3.4.3.2. Filters may be used in order to extract the solid particles from the sample.
 - 2.3.4.3.3. Pumps are required in order to convey the sample to the sampling bag(s).
 - 2.3.4.3.4. Flow control valves and flow-meters are needed in order to obtain the flow-rates required for sampling.

2.3.4.3.5. Quick-fastening gas-tight connections may be used between the three-way valves and the sampling bags, the connections sealing themselves automatically on the bag side. Other systems may be used for conveying the samples to the analyser (three-way stop valves, for example).

2.3.4.3.6. The various valves used for directing the sampling gases shall be of the quick-adjusting and quick-acting type.

2.3.4.4. Storage of the sample

The gas samples shall be collected in sampling bags of adequate capacity so as not to reduce the sampling rate. The bags shall be made of a material such as will not change the concentration of synthetic pollutant gases by more than ± 2 per cent after 20 minutes.

2.4. Additional sampling unit for the testing of vehicles equipped with a compression-ignition engine

2.4.1. Unlike the taking of gas samples from vehicles equipped with spark-ignition engines, the hydrocarbon and particulate sampling points are located in a dilution tunnel.

2.4.2. In order to reduce heat losses in the exhaust gases between the exhaust outlet and the dilution tunnel inlet, the pipe may not be more than 3.6 m long, or 6.1 m long if heat insulated. Its internal diameter may not exceed 105 mm.

2.4.3. Predominantly turbulent flow conditions (Reynolds number ≥ 4000) shall apply in the dilution tunnel, which shall consist of a straight tube of electrically-conductive material, in order to guarantee that the diluted exhaust gas is homogeneous at the sampling points and that the samples consist of representative gases and particulates. The dilution tunnel shall be at least 200 mm in diameter and the system shall be earthed.

2.4.4. The particulate sampling system shall consist of a sampling probe in the dilution tunnel and two series-mounted filters. Quick-acting valves shall be located both up and downstream of the two filters in the direction of flow.

The configuration of the sample probe shall be as indicated in Figure 5/2.

2.4.5. The particulate sampling probe shall meet the following conditions:

It shall be installed near the tunnel centreline, roughly ten tunnel diameters downstream of the gas inlet, and have an internal diameter of at least 12 mm.

The distance from the sampling tip to the filter mount shall be at least five probe diameters, but shall not exceed 1,020 mm.

- 2.4.6. The sample gas flow measuring unit shall consist of pumps, gas flow regulators and flow measuring units.
- 2.4.7. The hydrocarbon sampling system shall consist of a heated sampling probe, line, filter and pump. The sampling probe shall be installed at the same distance from the exhaust gas inlet as the particulate sampling probe, in such a way that neither interferes with samples taken by the other. It shall have a minimum internal diameter of 4 mm.
- 2.4.8. All heated parts shall be maintained at a temperature of 463 K (190 °C) \pm 10 K by the heating system.
- 2.4.9. If it is not possible to compensate for variations in the flow rate provision shall be made for a heat exchanger and a temperature control device as specified in paragraph 2.3.3.1. so as to ensure that the flow rate in the system is constant and the sampling rate accordingly proportional.

Figure 5/2

Particulate sampling probe configuration

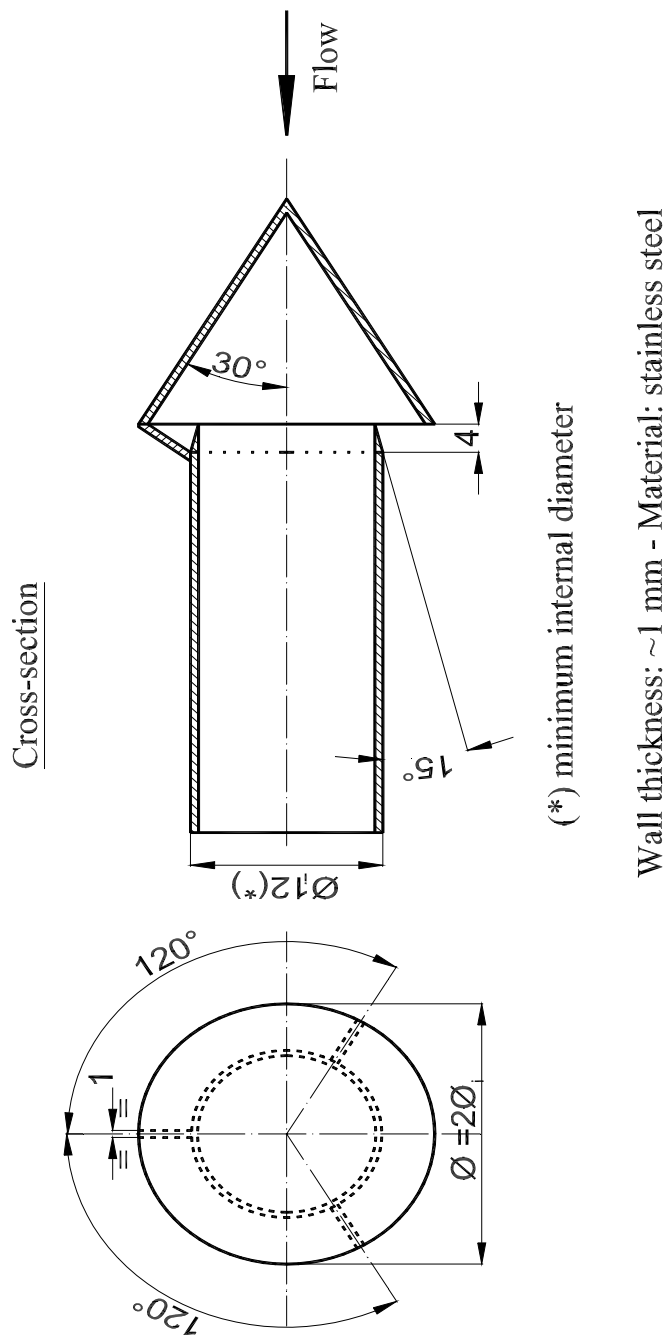

3. DESCRIPTION OF THE DEVICES

3.1. Variable dilution device with positive displacement pump (PDP-CVS) (Figure 5/3)

3.1.1. The positive displacement pump - constant volume sampler (PDP-CVS) satisfies the requirements of this annex by metering the flow of gas through the pump at constant temperature and pressure. The total volume is measured by counting the revolutions made by the calibrated positive displacement pump. The proportional sample is achieved by sampling with pump, flow-meter and flow control valve at a constant flow rate.

3.1.2. Figure 5/3 is a schematic drawing of such a sampling system. Since various configurations can produce accurate results, exact conformity with the drawing is not essential. Additional components such as instruments, valves, solenoids and switches may be used to provide additional information and co-ordinate the functions of the component system.

3.1.3. The sampling equipment consists of:

3.1.3.1. a filter (D) for the dilution air, which can be preheated if necessary. This filter shall consist of activated charcoal sandwiched between two layers of paper, and shall be used to reduce and stabilise the hydrocarbon concentrations of ambient emissions in the dilution air;

3.1.3.2. a mixing chamber (M) in which exhaust gas and air are mixed homogeneously;

3.1.3.3. a heat exchanger (H) of a capacity sufficient to ensure that throughout the test the temperature of the air/exhaust-gas mixture measured at a point immediately upstream of the positive displacement pump is within 6 K of the designed operating temperature. This device shall not affect the pollutant concentrations of diluted gases taken off after for analysis;

3.1.3.4. a temperature control system (TC), used to preheat the heat exchanger before the test and to control its temperature during the test, so that deviations from the designed operating temperature are limited to 6 K;

3.1.3.5. the positive displacement pump (PDP), producing a constant-volume flow of the air/exhaust-gas mixture; the flow capacity of the pump shall be large enough to eliminate water condensation in the system under all operating conditions which may occur during a test; this can be generally ensured by using a positive displacement pump with a flow capacity:

3.1.3.5.1. twice as high as the maximum flow of exhaust gas produced by accelerations of the driving cycle, or

- 3.1.3.5.2. sufficient to ensure that the CO₂ concentration in the dilute-exhaust sample bag is less than 3 per cent by volume for petrol and diesel, less than 2.2 per cent by volume for LPG and less than 1.5 per cent by volume for NG.
- 3.1.3.6. A temperature sensor (T₁), (accuracy and precision ± 0.4 kPa), fitted immediately upstream of the volume meter and used to register the pressure difference between the gas mixture and the ambient air;
- 3.1.3.7. A pressure gauge (G₁), (accuracy and precision ± 0.4 kPa), fitted immediately upstream of the positive displacement pump and used to register the pressure gradient between the gas mixture and the ambient air;
- 3.1.3.8. Another pressure gauge (G₂), accuracy and precision ± 0.4 kPa, fitted so that the differential pressure between pump inlet and pump outlet can be registered;
- 3.1.3.9. Two sampling probes (S₁ and S₂) for continuous sampling of the dilution air and of the diluted exhaust-gas/air mixture;
- 3.1.3.10. A filter (F), to extract solid particles from the flows of gas collected for analysis;
- 3.1.3.11. Pumps (P), to collect a constant flow of the dilution air as well as of the diluted exhaust-gas/air mixture during the test;
- 3.1.3.12. Flow controllers (N), to ensure a constant uniform flow of the gas samples taken during the course of the test from sampling probes S₁ and S₂ and flow of the gas samples shall be such that, at the end of each test, the quantity of the samples is sufficient for analysis (approx. 10 litres per minute);
- 3.1.3.13. Flow meters (FL), for adjusting and monitoring the constant flow of gas samples during the test;
- 3.1.3.14. Quick-acting valves (V), to divert a constant flow of gas samples into the sampling bags or to the outside vent;
- 3.1.3.15. Gas-tight, quick-lock coupling elements (Q) between the quick-acting valves and the sampling bags; the coupling shall close automatically on the sampling-bag side; as an alternative, other ways of transporting the samples to the analyser may be used (three-way stopcocks, for instance);
- 3.1.3.16. Bags (B), for collecting samples of the diluted exhaust gas and of the dilution air during the test; they shall be of sufficient capacity not to impede the sample flow; the bag material shall be such as to affect neither the measurements themselves nor the chemical composition of the gas samples (for instance: laminated polyethylene/polyamide films, or fluorinated polyhydrocarbons);

3.1.3.17. A digital counter (C), to register the number of revolutions performed by the positive displacement pump during the test.

3.1.4. Additional equipment required when testing compression-ignition-engined vehicles

To comply with the requirements of paragraphs 4.3.1.1. and 4.3.2. of Annex 4, the additional components within the dotted lines in Figure 5/3 shall be used when testing compression-ignition-engined vehicles:

F_h is a heated filter,

S₃ is a hydrocarbon sampling point,

V_h is a heated multi-way valve,

Q is a quick connector to allow the ambient air sample BA to be analysed on the HFID,

HFID is a heated flame ionisation analyser,

R and I are a means of integrating and recording the instantaneous hydrocarbon concentrations,

L_h is a heated sample line.

All heated components shall be maintained at 463 K (190 °C) ± 10 K.

Particulate sampling system:

S₄ Sampling probe in the dilution tunnel,

F_p Filter unit consisting of two series-mounted filters; switching arrangement for further parallel-mounted pairs of filters,

Sampling line,

Pumps, flow regulators, flow measuring units.

3.2. Critical-flow venturi dilution device (CFV-CVS) (Figure 5/4)

3.2.1. The use of a critical-flow venturi in connection with the CVS sampling procedure is based on the principles of flow mechanics for critical flow. The variable mixture flow rate of dilution and exhaust gas is maintained at sonic velocity which is directly proportional to the square root of the gas temperature. Flow is continually monitored, computed and integrated throughout the test.

The use of an additional critical-flow sampling venturi ensures the proportionality of the gas samples taken. As both pressure and temperature are equal at the two venturi inlets the volume of the gas flow diverted for sampling is proportional to the total volume of diluted exhaust-gas mixture produced, and thus the requirements of this Annex are met.

Figure 5/3

Constant volume sampler with positive displacement pump (PDP-CVS)

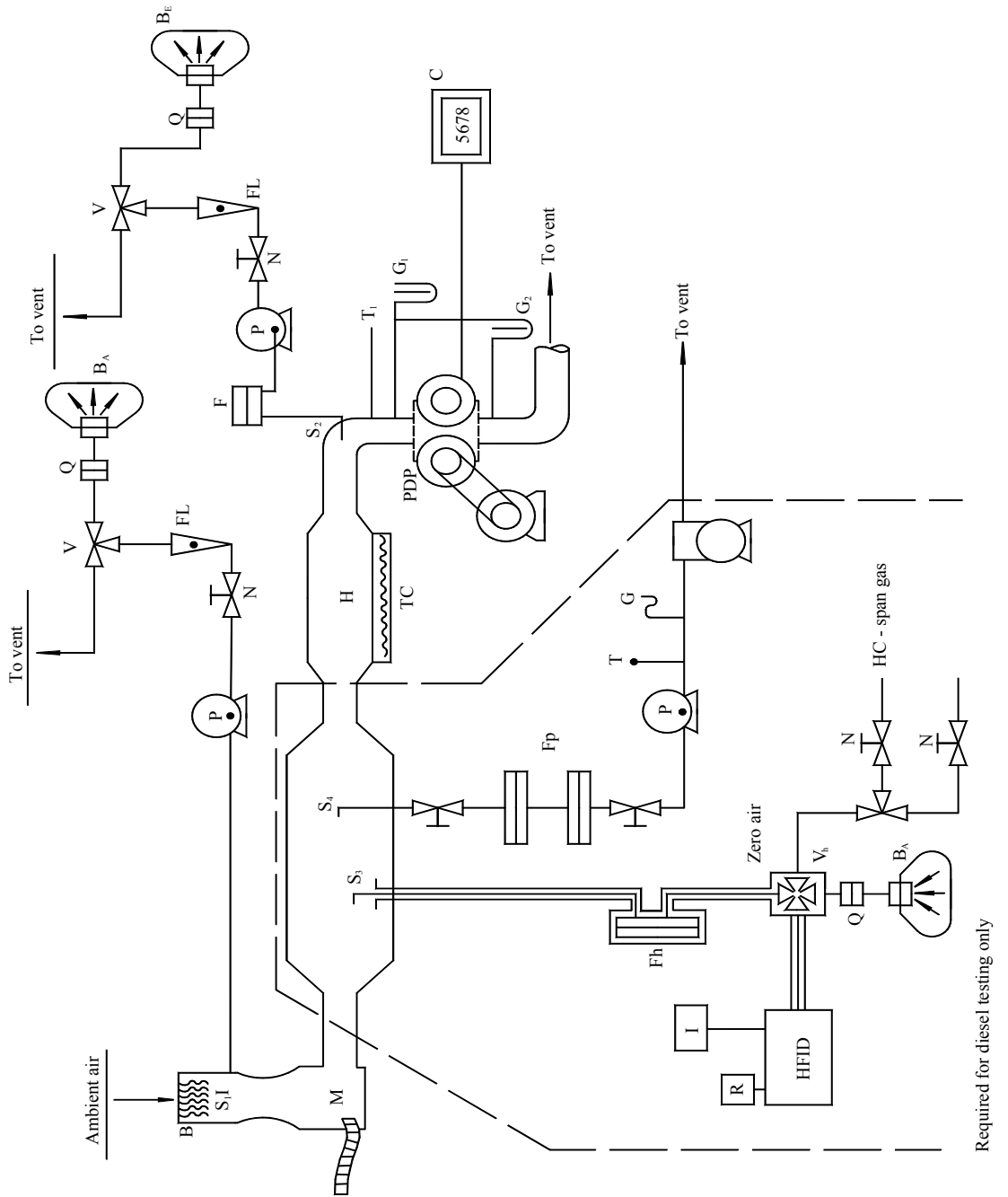
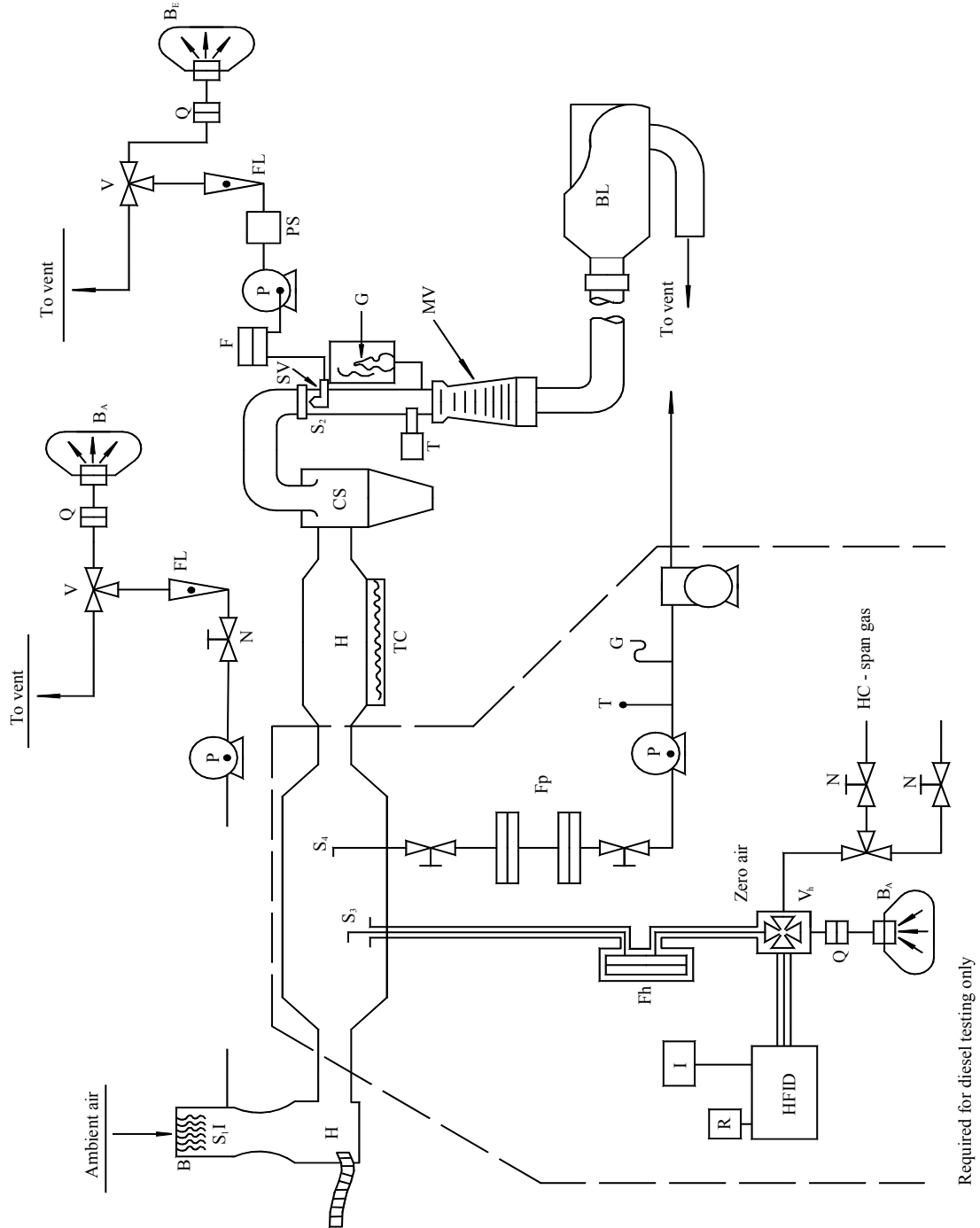

Figure 5/4

Constant volume sampler with critical-flow venturi (CFV-CVS System)



- 3.2.2. Figure 5/4 is a schematic drawing of such a sampling system. Since various configurations can produce accurate results, exact conformity with the drawing is not essential. Additional components such as instruments, valve, solenoids, and switches may be used to provide additional information and co-ordinate the functions of the component system.
- 3.2.3. The collecting equipment consists of:
- 3.2.3.1. a filter (D) for the dilution air, which can be preheated if necessary: the filter shall consist of activated charcoal sandwiched between layers of paper, and shall be used to reduce and stabilise the hydrocarbon background emission of the dilution air;
 - 3.2.3.2. a mixing chamber (M), in which exhaust gas and air are mixed homogeneously;
 - 3.2.3.3. a cyclone separator (CS), to extract particles;
 - 3.2.3.4. two sampling probes (S_1 and S_2) for taking samples of the dilution air, as well as of the diluted exhaust gas;
 - 3.2.3.5. a sampling critical-flow venturi (SV), to take proportional samples of the diluted exhaust gas at sampling probe S_2 ;
 - 3.2.3.6. a filter (F), to extract solid particles from the gas flows diverted for analysis;
 - 3.2.3.7. pumps (P), to collect part of the flow of air and diluted exhaust gas in bags during the test;
 - 3.2.3.8. a flow controller (N), to ensure a constant flow of the gas samples taken in the course of the test from sampling probe S_1 ; the flow of the gas samples shall be such that, at the end of the test, the quantity of the samples is sufficient for analysis (approx. 10 litres per minute);
 - 3.2.3.9. a snubber (PS), in the sampling line;
 - 3.2.3.10. flow meters (FL), for adjusting and monitoring the flow of gas samples during tests;
 - 3.2.3.11. quick-acting solenoid valves (V), to divert a constant flow of gas samples into the sampling bags or the vent;
 - 3.2.3.12. gas-tight, quick-lock coupling elements (Q), between the quick-acting valves and the sampling bags; the couplings shall close automatically on the sampling-bag side. As an alternative, other ways of transporting the samples to the analyser may be used (three-way stop-cocks, for instance);

- 3.2.3.13. bags (B) for collecting samples of the diluted exhaust gas and the dilution air during the tests; they shall be of sufficient capacity not to impede the sample flow; the bag material shall be such as to affect neither the measurements themselves nor the chemical composition of the gas samples (for instance: laminated polyethylene/polyamide films, or fluorinated poly-hydrocarbons);
- 3.2.3.14. a pressure gauge (G), which shall be precise and accurate to within ± 0.4 kPa;
- 3.2.3.15. a temperature sensor (T), which is precise and accurate to within ± 1 K and has a response time of 0.1 seconds to 62 per cent of a temperature change (as measured in silicon oil);
- 3.2.3.16. a measuring critical-flow venturi tube (MV), to measure the flow volume of the diluted exhaust gas;
- 3.2.3.17. a blower (BL), of sufficient capacity to handle the total volume of diluted exhaust gas.
- 3.2.3.18. The capacity of the CFV-CVS system shall be such that, under all operating conditions which may possibly occur during a test, there will be no condensation of water. This is generally ensured by using a blower whose capacity is:
- 3.2.3.18.1. twice as high as the maximum flow of exhaust gas produced by accelerations of the driving cycle; or
- 3.2.3.18.2. sufficient to ensure that the CO₂ concentration in the dilute exhaust sample bag is less than 3 per cent by volume.
- 3.2.4. Additional equipment required when testing compression-ignition-engined vehicles

To comply with the requirements of paragraphs 4.3.1.1. and 4.3.2. of Annex 4, the additional components shown within the dotted lines of Figure 5/4 shall be used when testing compression-ignition-engined vehicles.

F _h	is a heated filter,
S ₃	is a hydrocarbon sampling point,
V _h	is a heated multi-way valve,
Q	is a quick connector to allow the ambient air sample BA to be analysed on the HFID,
HFID	is a heated flame ionisation analyser,

R and I are a means of integrating and recording the instantaneous hydrocarbon concentrations,

L_h is a heated sample line.

All heated components shall be maintained at 463 K (190 °C) ± 10 K.

If compensation for varying flow is not possible, then a heat exchanger (H) and temperature control system (Tc) as described in paragraph 3.1.3. of this Appendix will be required to ensure constant flow through the venturi (Mv) and thus proportional flow through S₃ particulate sampling system.

S₄ Sampling probe in dilution tunnel,

Fp Filter unit, consisting of two series-mounted filters; switching unit for further parallel-mounted pairs of filters,

Sampling line,

Pumps, flow regulators, flow measuring units.

Annex 4 - Appendix 6

METHOD OF CALIBRATING THE EQUIPMENT

1. ESTABLISHMENT OF THE CALIBRATION CURVE

- 1.1. Each normally used operating range is calibrated in accordance with the requirements of paragraph 4.3.3. of Annex 4 by the following procedure:
- 1.2. The analyser calibration curve is established by at least five calibration points spaced as uniformly as possible. The nominal concentration of the calibration gas of the highest concentration shall be not less than 80 per cent of the full scale.
- 1.3. The calibration curve is calculated by the least squares method. If the resulting polynomial degree is greater than 3, the number of calibration points shall be at least equal to this polynomial degree plus 2.
- 1.4. The calibration curve shall not differ by more than ± 2 per cent from the nominal value of each calibration gas.
- 1.5. Trace of the calibration curve

From the trace of the calibration curve and the calibration points, it is possible to verify that the calibration has been carried out correctly. The different characteristic parameters of the analyser shall be indicated, particularly:

the scale,
the sensitivity,
the zero point,
the date of carrying out the calibration.

- 1.6. If it can be shown to the satisfaction of the technical service that alternative technology (e.g. computer, electronically controlled range switch, etc.) can give equivalent accuracy, then these alternatives may be used.
- 1.7. Verification of the calibration
 - 1.7.1. Each normally used operating range shall be checked prior to each analysis in accordance with the following:
 - 1.7.2. The calibration shall be checked by using a zero gas and a span gas whose nominal value is within 80-95 per cent of the supposed value to be analysed.

1.7.3. If, for the two points considered, the value found does not differ by more than ± 5 per cent of the full scale from the theoretical value, the adjustment parameters may be modified. Should this not be the case, a new calibration curve shall be established in accordance with paragraph 1 of this Appendix.

1.7.4. After testing, zero gas and the same span gas are used for re-checking. The analysis is considered acceptable if the difference between the two measuring results is less than 2 per cent.

2. CHECKING FOR FID HYDROCARBON RESPONSE

2.1. Detector response optimisation

The FID shall be adjusted, as specified by the instrument manufacturer. Propane in air should be used, to optimise the response, on the most common operating range.

2.2. Calibration of the HC analyser

The analyser should be calibrated using propane in air and purified synthetic air. See paragraph 4.5.2. of Annex 4 (calibration and span gases).

Establish a calibration curve as described in paragraphs 1.1. to 1.5. of this Appendix.

2.3. Response factors of different hydrocarbons and recommended limits

The response factor (Rf), for a particular hydrocarbon species is the ratio of the FID C_1 reading to the gas cylinder concentration, expressed as ppm C_1 .

The concentration of the test gas shall be at a level to give a response of approximately 80 per cent of full-scale deflection, for the operating range. The concentration shall be known, to an accuracy of ± 2 per cent in reference to a gravimetric standard expressed in volume. In addition, the gas cylinder shall be pre-conditioned for 24 hours at a temperature between 293 K and 303 K (20 and 30 °C).

Response factors should be determined when introducing an analyser into service and thereafter at major service intervals. The test gases to be used and the recommended response factors are:

Methane and purified air: $1.00 < Rf < 1.15$

or $1.00 < Rf < 1.05$ for NG fuelled vehicles

Propylene and purified air: $0.90 < R_f < 1.00$

Toluene and purified air: $0.90 < R_f < 1.00$

Relative to a response factor (R_f) of 1.00 for propane and purified air.

2.4. Oxygen interference check and recommended limits

The response factor shall be determined as described in paragraph 2.3. above. The test gas to be used and recommended response factor range is:

Propane and nitrogen: $0.95 < R_f < 1.05$

3. EFFICIENCY TEST OF THE NO_x CONVERTER

The efficiency of the converter used for the conversion of NO₂ into NO is tested as follows:

Using the test set up as shown in Figure 6/1 and the procedure described below, the efficiency of converters can be tested by means of an ozonator.

- 3.1. Calibrate the analyzer in the most common operating range following the manufacturer's specifications using zero and span gas (the NO content of which shall amount to about 80 per cent of the operating range and the NO₂ concentration of the gas mixture shall be less than 5 per cent of the NO concentration). The NO_x analyser shall be in the NO mode so that the span gas does not pass through the converter. Record the indicated concentration.
- 3.2. Via a T-fitting, oxygen or synthetic air is added continuously to the span gas flow until the concentration indicated is about 10 per cent less than the indicated calibration concentration given in paragraph 3.1. above. Record the indicated concentration (C). The ozonator is kept deactivated throughout this process.
- 3.3. The ozonator is now activated to generate enough ozone to bring the NO concentration down to 20 per cent (minimum 10 per cent) of the calibration concentration given in paragraph 3.1. above. Record the indicated concentration (d).
- 3.4. The NO_x analyser is then switched to the NO_x mode, which means that the gas mixture (consisting of NO, NO₂, O₂ and N₂) now passes through the converter. Record the indicated concentration (a).
- 3.5. The ozonator is now deactivated. The mixture of gases described in paragraph 3.2. above passes through the converter into the detector. Record the indicated concentration (b).

Figure 6/1

Diagram of NO_x converter efficiency devices

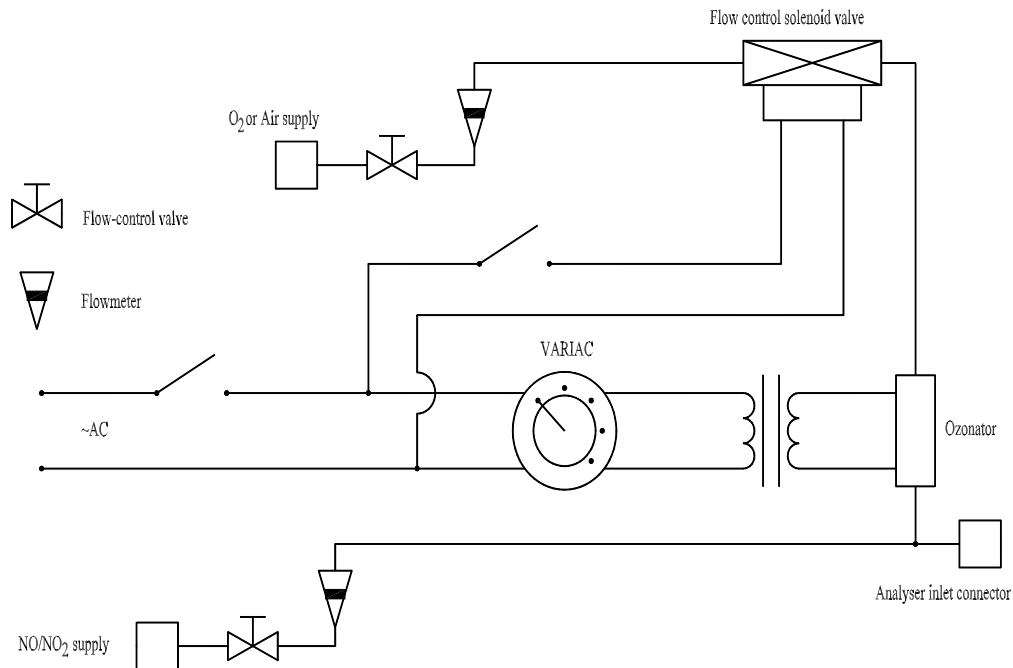

3.6. With the ozonator deactivated, the flow of oxygen or synthetic air is also shut off. The NO₂ reading of the analyser shall then be no more than 5 per cent above the figure given in paragraph 3.1. above.

3.7. The efficiency of the NO_x converter is calculated as follows:

$$\text{Efficiency (per cent)} = \left(1 + \frac{a-b}{c-d}\right) \cdot 100$$

3.8. The efficiency of the converter shall not be less than 95 per cent.

3.9. The efficiency of the converter shall be tested at least once a week.

4. CALIBRATION OF THE CVS SYSTEM

4.1. The CVS system shall be calibrated by using an accurate flowmeter and a restricting device. The flow through the system shall be measured at various pressure readings and the control parameters of the system measured and related to the flows.

4.1.1. Various types of flowmeter may be used, e.g. calibrated venturi, laminar flowmeter, calibrated turbine-meter, provided that they are dynamic measurement systems and can meet the requirements of paragraphs 4.4.1. and 4.4.2. of Annex 4.

4.1.2. The following paragraphs give details of methods of calibrating PDP and CFV units, using a laminar flowmeter, which gives the required accuracy, together with a statistical check on the calibration validity.

4.2. Calibration of the positive displacement pump (PDP)

4.2.1. The following calibration procedure outlines the equipment, the test configuration and the various parameters which are measured to establish the flow-rate of the CVS pump. All the parameters related to the pump are simultaneously measured with the parameters related to the flowmeter which is connected in series with the pump. The calculated flow-rate (given in m^3/min . at pump inlet, absolute pressure and temperature) can then be plotted versus a correlation function which is the value of a specific combination of pump parameters. The linear equation which relates the pump flow and the correlation function is then determined. In the event that a CVS has a multiple speed drive, a calibration for each range used shall be performed.

4.2.2. This calibration procedure is based on the measurement of the absolute values of the pump and flowmeter parameters that relate the flow rate at each point. Three conditions shall be maintained to ensure the accuracy and integrity of the calibration curve:

4.2.2.1. the pump pressures shall be measured at tappings on the pump rather than at the external piping on the pump inlet and outlet. Pressure taps that are mounted at the top centre and bottom centre of the pump drive headplate are exposed to the actual pump cavity pressures, and therefore reflect the absolute pressure differentials;

4.2.2.2. temperature stability shall be maintained during the calibration. The laminar flowmeter is sensitive to inlet temperature oscillations which cause the data points to be scattered. Gradual changes of ± 1 K in temperature are acceptable as long as they occur over a period of several minutes;

4.2.2.3. all connections between the flowmeter and the CVS pump shall be free of any leakage.

4.2.3. During an exhaust emission test, the measurement of these same pump parameters enables the user to calculate the flow rate from the calibration equation.

4.2.3.1. Figure 6/2 of this Appendix shows one possible test set-up. Variations are permissible, provided that they are approved by the administration granting the approval as being of comparable accuracy. If the set-up shown in Appendix 5, Figure 5/3, is used, the following data shall be found within the limits of precision given:

barometric pressure (corrected)(P_b)	± 0.03 kPa
ambient temperature (T)	± 0.2 K
air temperature at LFE (ETI)	± 0.15 K
pressure depression upstream of LFE (EPI)	± 0.01 kPa
pressure drop across the LFE matrix (EDP)	± 0.0015 kPa
air temperature at CVS pump inlet (PTI)	± 0.2 K
air temperature at CVS pump outlet (PTO)	± 0.2 K
pressure depression at CVS pump inlet (PPI)	± 0.22 kPa
pressure head at CVS pump outlet (PPO)	± 0.22 kPa
pump revolutions during test period (n)	± 1 1/min
elapsed time for period (minimum 250 s) (t)	± 0.1 s

4.2.3.2. After the system has been connected as shown in Figure 6/2 of this Appendix, set the variable restrictor in the wide-open position and run the CVS pump for 20 minutes before starting the calibration.

4.2.3.3. Reset the restrictor valve to a more restricted condition in an increment of pump inlet depression (about 1 kPa) that will yield a minimum of six data points for the total calibration. Allow the system to stabilise for three minutes and repeat the data acquisition.

Figure 6/2

PDP-CVS calibration configuration

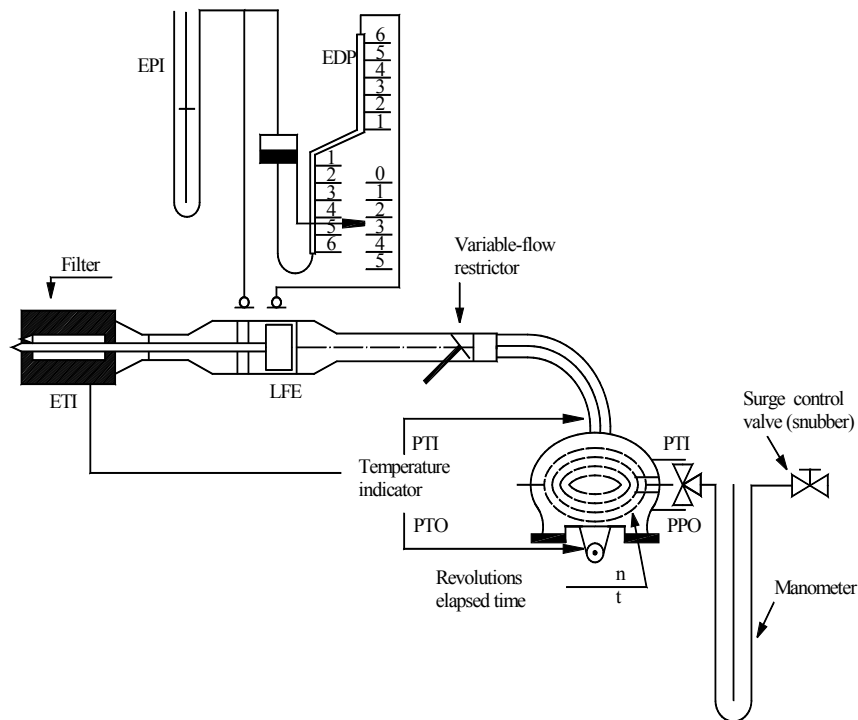

4.2.4. Data analysis

4.2.4.1. The air flow rate (Q_s) at each test point is calculated in standard $m^3/min.$ from the flowmeter data using the manufacturer's prescribed method.

4.2.4.2. The air flow-rate is then converted to pump flow (V_0) in m^3/rev at absolute pump inlet temperature and pressure.

$$V_0 = \frac{Q_s}{n} \cdot \frac{T_p}{273.2} \cdot \frac{101.33}{P_p}$$

where:

V_0 = pump flow rate at T_p and P_p given in $m^3/rev.$,

Q_s = air flow at 101.33 kPa and 273.2 K given in m^3 in $m^3/min.$,

T_p = pump inlet temperature (K),

P_p = absolute pump inlet pressure (kPa),

n = pump speed in min^{-1} .

To compensate for the interaction of pump speed pressure variations at the pump and the pump slip rate, the correlation function (x_0) between the pump speed (n), the pressure differential from pump inlet to pump outlet and the absolute pump outlet pressure is then calculated as follows:

$$x_0 = \frac{1}{n} \sqrt{\frac{\Delta P_p}{P_e}}$$

where:

x_0 = correlation function,

ΔP_p = pressure differential from pump inlet to pump outlet (kPa),

P_e = absolute outlet pressure ($PPO + P_b$)(kPa).

A linear least-square fit is performed to generate the calibration equations which have the formulae:

$$V_0 = D_0 - M (x_0)$$

$$n = A - B (\Delta P_p)$$

D_0 , M , A and B are the slope-intercept constants describing the lines.

Figure 6/3

CFV-CVS calibration configuration

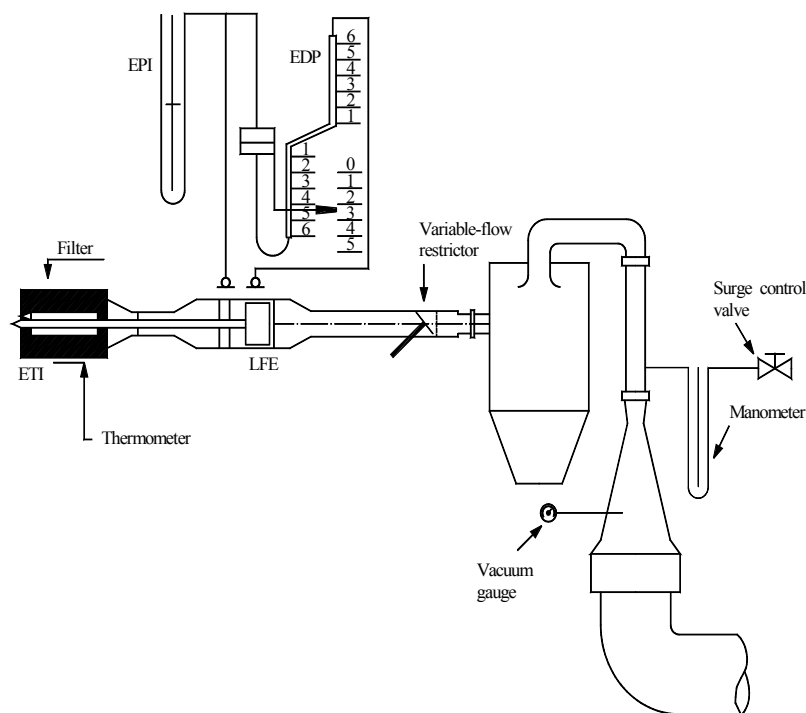

4.2.4.3. A CVS system that has multiple speeds shall be calibrated on each speed used. The calibration curves generated for the ranges shall be approximately parallel and the intercept values (D_0) shall increase as the pump flow range decreases.

If the calibration has been performed carefully, the calculated values from the equation will be within 0.5 per cent of the measured value of V_0 . Values of M will vary from one pump to another. Calibration is performed at pump start-up and after major maintenance.

4.3. Calibration of the critical-flow venturi (CFV)

4.3.1. Calibration of the CFV is based upon the flow equation for a critical venturi:

$$Q_s = \frac{K_v \cdot P}{\sqrt{T}}$$

where:

Q_s = flow,

K_v = calibration coefficient,

P = absolute pressure (kPa),

T = absolute temperature (K).

Gas flow is a function of inlet pressure and temperature.

The calibration procedure described below establishes the value of the calibration coefficient at measured values of pressure, temperature and air flow.

- 4.3.2. The manufacturer's recommended procedure shall be followed for calibrating electronic portions of the CFV.
- 4.3.3. Measurements for flow calibration of the critical flow venturi are required and the following data shall be found within the limits of precision given:
- | | |
|---|---------------------|
| barometric pressure (corrected) (P_b) | ± 0.03 kPa, |
| LFE air temperature, flowmeter (ETI) | ± 0.15 K, |
| pressure depression upstream of LFE (EPI) | ± 0.01 kPa, |
| pressure drop across (EDP) LFE matrix | ± 0.0015 kPa, |
| air flow (Q_s) | ± 0.5 per cent, |
| CFV inlet depression (PPI) | ± 0.02 kPa, |
| temperature at venturi inlet (T_v) | ± 0.2 K. |
- 4.3.4. The equipment shall be set up as shown in Figure 3 of this Appendix and checked for leaks. Any leaks between the flow-measuring device and the critical-flow venturi will seriously affect the accuracy of the calibration.
- 4.3.5. The variable-flow restrictor shall be set to the open position, the blower shall be started and the system stabilised. Data from all instruments shall be recorded.
- 4.3.6. The flow restrictor shall be varied and at least eight readings across the critical flow range of the venturi shall be made.
- 4.3.7. The data recorded during the calibration shall be used in the following calculations. The air flow-rate (Q_s) at each test point is calculated from the flowmeter data using the manufacturer's prescribed method.

Calculate values of the calibration coefficient for each test point:

$$K_v = \frac{Q_s \cdot \sqrt{T_v}}{P_v}$$

where:

Q_s = flow-rate in m³/min. at 273.2 K and 101.33 kPa,

T_v = temperature at the venturi inlet (K),

P_v = absolute pressure at the venturi inlet (kPa).

Plot K_v as a function of venturi inlet pressure. For sonic flow, K_v will have a relatively constant value. As pressure decreases (vacuum increases) the venturi becomes unchoked and K_v decreases. The resultant K_v changes are not permissible.

For a minimum of eight points in the critical region, calculate an average K_v and the standard deviation.

If the standard deviation exceeds 0.3 per cent of the average K_v , take corrective action.

Annex 4 - Appendix 7

TOTAL SYSTEM VERIFICATION

1. To comply with the requirements of paragraph 4.7. of Annex 4, the total accuracy of the CVS sampling system and analytical system shall be determined by introducing a known mass of a pollutant gas into the system whilst it is being operated as if during a normal test and then analysing and calculating the pollutant mass according to the formulae in Appendix 8 to Annex 4 except that the density of propane shall be taken as 1.967 grams per litre at standard conditions. The following two techniques are known to give sufficient accuracy.
2. Metering a constant flow of pure gas (CO or C₃H₈) using a critical flow orifice device
 - 2.1. A known quantity of pure gas (CO OR C₃H₈) is fed into the CVS system through the calibrated critical orifice. If the inlet pressure is high enough, the flow-rate (q), which is adjusted by means of the critical flow orifice, is independent of orifice outlet pressure (critical flow). If deviations exceeding 5 per cent occur, the cause of the malfunction shall be determined and corrected. The CVS system is operated as in an exhaust emission test for about 5 to 10 minutes. The gas collected in the sampling bag is analysed by the usual equipment and the results compared to the concentration of the gas samples which was known beforehand.
3. Metering a limited quantity of pure gas (CO or C₃H₈) by means of a gravimetric technique
 - 3.1. The following gravimetric procedure may be used to verify the CVS system.

The weight of a small cylinder filled with either carbon monoxide or propane is determined with a precision of ± 0.01 g. For about 5 to 10 minutes, the CVS system is operated as in a normal exhaust emission test, while CO or propane is injected into the system. The quantity of pure gas involved is determined by means of differential weighing. The gas accumulated in the bag is then analysed by means of the equipment normally used for exhaust-gas analysis. The results are then compared to the concentration figures computed previously.

Annex 4 - Appendix 8

CALCULATION OF THE MASS EMISSIONS OF POLLUTANTS

1. GENERAL PROVISIONS

- 1.1. Mass emissions of gaseous pollutants shall be calculated by means of the following equation:

$$M_i = \frac{V_{\text{mix}} \cdot Q_i \cdot k_h \cdot C_i \cdot 10^{-6}}{d} \quad (1)$$

where:

- M_i = mass emission of the pollutant i in grams per kilometre,
- V_{mix} = volume of the diluted exhaust gas expressed in litres per test and corrected to standard conditions (273.2 K and 101.33 kPa),
- Q_i = density of the pollutant i in grams per litre at normal temperature and pressure (273.2 K and 101.33 kPa),
- k_h = humidity correction factor used for the calculation of the mass emissions of oxides of nitrogen. There is no humidity correction for HC and CO,
- C_i = concentration of the pollutant i in the diluted exhaust gas expressed in ppm and corrected by the amount of the pollutant i contained in the dilution air,
- d = distance corresponding to the operating cycle in kilometres.

1.2. VOLUME DETERMINATION

- 1.2.1. Calculation of the volume when a variable dilution device with constant flow control by orifice or venturi is used

Record continuously the parameters showing the volumetric flow, and calculate the total volume for the duration of the test.

1.2.2. Calculation of volume when a positive displacement pump is used

The volume of diluted exhaust gas measured in systems comprising a positive displacement pump is calculated with the following formula:

$$V = V_o \cdot N$$

where:

V = volume of the diluted gas expressed in litres per test (prior to correction),

V_o = volume of gas delivered by the positive displacement pump in testing conditions in litres per revolution,

N = number of revolutions per test.

1.2.3. Correction of the diluted exhaust-gas volume to standard conditions

The diluted exhaust-gas volume is corrected by means of the following formula:

$$V_{\text{mix}} = V \cdot K_1 \cdot \left(\frac{P_B - P_1}{T_p} \right) \quad (2)$$

in which:

$$K_1 = \frac{273.2 \text{ (K)}}{101.33 \text{ (kPa)}} = 2.6961 \quad (\text{K} / \text{kPa}) \quad (3)$$

where:

P_B = barometric pressure in the test room in kPa,

P₁ = vacuum at the inlet to the positive displacement pump in kPa relative to the ambient barometric pressure,

T_p = average temperature of the diluted exhaust gas entering the positive displacement pump during the test (K).

1.3. CALCULATION OF THE CORRECTED CONCENTRATION OF POLLUTANTS IN THE SAMPLING BAG

$$C_i = C_e - C_d \left(1 - \frac{1}{DF} \right) \quad (4)$$

where:

C_i = concentration of the pollutant i in the diluted exhaust gas, expressed in ppm and corrected by the amount of i contained in the dilution air,

C_e = measured concentration of pollutant i in the diluted exhaust gas, expressed in ppm,

C_d = concentration of pollutant i in the air used for dilution, expressed in ppm,

DF = dilution factor.

The dilution factor is calculated as follows:

For petrol and diesel

$$DF = \frac{13.4}{C_{CO_2} + (C_{HC} = C_{CO}) \cdot 10^{-4}} \quad \text{for petrol and diesel} \quad (5a)$$

$$DF = \frac{11.9}{C_{CO_2} + (C_{HC} = C_{CO}) \cdot 10^{-4}} \quad \text{for LPG} \quad (5b)$$

$$DF = \frac{9.5}{C_{CO_2} + (C_{HC} = C_{CO}) \cdot 10^{-4}} \quad \text{for NG} \quad (5c)$$

In these equations:

C_{CO_2} = concentration of CO_2 in the diluted exhaust gas contained in the sampling bag, expressed in per cent volume,

C_{HC} = concentration of HC in the diluted exhaust gas contained in the sampling bag, expressed in ppm carbon equivalent,

C_{CO} = concentration of CO in the diluted exhaust gas contained in the sampling bag, expressed in ppm.

1.4. DETERMINATION OF THE NO HUMIDITY CORRECTION FACTOR

In order to correct the influence of humidity on the results of oxides of nitrogen, the following calculations are applied:

$$k_h = \frac{1}{1 - 0.0329 (H - 10.71)} \quad (6)$$

in which:

$$H = \frac{6.211 \cdot R_a \cdot P_d}{P_B - P_d \cdot R_a \cdot 10^{-2}}$$

where:

H = absolute humidity expressed in grams of water per kilogram of dry air,

R_a = relative humidity of the ambient air expressed as a percentage,

P_d = saturation vapour pressure at ambient temperature expressed in kPa,

P_B = atmospheric pressure in the room, expressed in kPa.

1.5. EXAMPLE

1.5.1. Data

1.5.1.1. Ambient conditions:

ambient temperature: 23 °C = 297.2 K,

barometric pressure: P_B = 101.33 kPa,

relative humidity: R_a = 60 per cent,

saturation vapour pressure: P_d = 2.81 kPa of H₂O at 23 °C.

1.5.1.2. Volume measured and reduced to standard conditions (para. 1.)

$$V = 51.961 \text{ m}^3$$

1.5.1.3. Analyser readings:

	Diluted exhaust sample	Dilution-air sample
HC (1)	92 ppm	3.0 ppm
CO	470 ppm	0 ppm
NO _x	70 ppm	0 ppm
CO ₂	1.6 per cent by volume	0.03 per cent by volume

(1) in ppm carbon equivalent

1.5.2. Calculations

1.5.2.1. Humidity correction factor (k_H) (see formula 6):

$$H = \frac{6.211 \cdot R_a \cdot P_d}{P_B - P_d \cdot R_a \cdot 10^{-2}}$$

$$H = \frac{6.211 \cdot 60}{101.33 - (2.81 \cdot 60 \cdot 10^{-2})}$$

$$H = 10.5092$$

$$k_h = \frac{1}{1 - 0.0329 \cdot (H - 10.71)}$$

$$k_h = \frac{1}{1 - 0.0329 \cdot (10.5092 - 10.71)}$$

$$k_h = 0.9934$$

1.5.2.2. Dilution factor (DF) (see formula (5))

$$DF = \frac{13.4}{C_{CO_2} + (C_{HC} + C_{CO}) \cdot 10^{-4}}$$

$$DF = \frac{13.4}{1.6 + (92 + 4.70) \cdot 10^{-4}}$$

$$DF = 8.091$$

1.5.2.3. Calculation of the corrected concentration of pollutants in the sampling bag:

HC, mass emissions (see formulae (4) and (1))

$$C_i = C_e - C_d \left(1 - \frac{1}{DF}\right)$$

$$C_i = 92 - 3 \left(1 - \frac{1}{8.091}\right)$$

$$C_i = 89.371$$

$$M_{HC} = C_{HC} \cdot V_{mix} \cdot Q_{HC} \cdot \frac{1}{d}$$

$$Q_{HC} = 0.619 \quad \text{in the case of petrol or diesel}$$

$$Q_{HC} = 0.649 \quad \text{in the case of LPG}$$

$$Q_{HC} = 0.714 \quad \text{in the case of NG}$$

$$M_{HC} = 89.371 \cdot 51.961 \cdot 0.619 \cdot 10^{-6} \cdot \frac{1}{d}$$

$$M_{HC} = \frac{2.88}{d} \quad \text{g/km}$$

CO, mass emissions (see formula (1))

$$M_{CO} = C_{CO} \cdot V_{mix} \cdot Q_{CO} \cdot \frac{1}{d}$$

$$Q_{CO} = 1.25$$

$$M_{CO} = 470 \cdot 51.961 \cdot 1.25 \cdot 10^{-6} \cdot \frac{1}{d}$$

$$M_{CO} = \frac{30.5}{d} \quad \text{g/km}$$

NO_x mass emissions (see formula (1))

$$M_{NOx} = C_{NOx} \cdot V_{mix} \cdot Q_{NOx} \cdot k_H \cdot \frac{1}{d}$$

$$Q_{NOx} = 2.05$$

$$M_{NOx} = 70 \cdot 51.961 \cdot 2.05 \cdot 0.9934 \cdot 10^{-6} \cdot \frac{1}{d}$$

$$M_{NOx} = \frac{7.41}{d} \quad \text{g/km}$$

2. SPECIAL PROVISIONS FOR VEHICLES EQUIPPED WITH COMPRESSION-IGNITION ENGINES

2.1. Determination of HC for compression-ignition engines

To calculate HC-mass emission for compression-ignition engines, the average HC concentration is calculated as follows:

$$C_e = \frac{\int_{t_1}^{t_2} C_{HC} \cdot dt}{t_2 - t_1} \quad (7)$$

where:

$$\int_{t_1}^{t_2} C_{HC} \cdot dt = \text{integral of the recording of the heated FID over the test (t}_2\text{-t}_1\text{)}$$

C_e = concentration of HC measured in the diluted exhaust in ppm of C_1 is substituted for C_{HC} in all relevant equations.

2.2. Determination of particulates

Particulate emission M_p (g/km) is calculated by means of the following equation:

$$M_p = \frac{(V_{mix} + V_{ep}) \cdot P_e}{V_{ep} \cdot d}$$

where exhaust gases are vented outside tunnel;

$$M_p = \frac{V_{mix} \cdot P_e}{V_{ep} \cdot d}$$

where exhaust gases are returned to the tunnel.

where:

V_{mix} = Volume of diluted exhaust gases (see para. 1.1.), under standard conditions,

V_{ep} = Volume of exhaust gas flowing through particulate filter under standard conditions,

P_e = Particulate mass collected by filters,

d = Distance corresponding to the operating cycle in km,

M_p = Particulate emission in g/km.

Annex 5

TYPE II TEST

(Carbon monoxide emission test at idling speed)

1. INTRODUCTION

This Annex describes the procedure for the Type II test defined in paragraph 5.3.2. of this Regulation.

2. CONDITIONS OF MEASUREMENT

2.1. The fuel shall be the reference fuel, specifications for which are given in Annexes 10 and 10a to this Regulation.

2.2. During the test, the environmental temperature shall be between 293 and 303 K (20 and 30 °C). The engine shall be warmed up until all temperatures of cooling and lubrication means and the pressure of lubrication means have reached equilibrium.

2.2.1. Vehicles that are fuelled either with petrol or with LPG or NG shall be tested with the reference fuel(s) used for the Type I test.

2.3. In the case of vehicles with manually-operated or semi-automatic-shift gearboxes, the test shall be carried out with the gear lever in the "neutral" position and with the clutch engaged.

2.4. In the case of vehicles with automatic-shift gearboxes, the test shall be carried out with the gear selector in either the "neutral" or the "parking" position.

2.5. Components for adjusting the idling speed

2.5.1. Definition

For the purposes of this Regulation, "components for adjusting the idling speed" means controls for changing the idling conditions of the engine which may be easily operated by a mechanic using only the tools described in paragraph 2.5.1.1. below. In particular, devices for calibrating fuel and air flows are not considered as adjustment components if their setting requires the removal of the set-stops, an operation which cannot normally be performed except by a professional mechanic.

2.5.1.1. Tools which may be used to control components for adjusting the idling speed: screwdrivers (ordinary or cross-headed), spanners (ring, open-end or adjustable), pliers, Allen keys.

- 2.5.2. Determination of measurement points
- 2.5.2.1. A measurement at the setting in accordance with the conditions fixed by the manufacturer is performed first;
- 2.5.2.2. For each adjustment component with a continuous variation, a sufficient number of characteristic positions shall be determined.
- 2.5.2.3. The measurement of the carbon-monoxide content of exhaust gases shall be carried out for all the possible positions of the adjustment components, but for components with a continuous variation only the positions defined in paragraph 2.5.2.2. above shall be adopted.
- 2.5.2.4. The Type II test shall be considered satisfactory if one or both of the two following conditions is met:
- 2.5.2.4.1. none of the values measured in accordance with paragraph 2.5.2.3. above exceeds the limit values;
- 2.5.2.4.2. the maximum content obtained by continuously varying one of the adjustment components while the other components are kept stable does not exceed the limit value, this condition being met for the various combinations of adjustment components other than the one which was varied continuously.
- 2.5.2.5. The possible positions of the adjustment components shall be limited:
- 2.5.2.5.1. on the one hand, by the larger of the following two values: the lowest idling speed which the engine can reach; the speed recommended by the manufacturer, minus 100 revolutions per minute;
- 2.5.2.5.2. on the other hand, by the smallest of the following three values:
the highest speed the engine can attain by activation of the idling speed components;
the speed recommended by the manufacturer, plus 250 revolutions per minute;
the cut-in speed of automatic clutches.
- 2.5.2.6. In addition, settings incompatible with correct running of the engine shall not be adopted as measurement settings. In particular, when the engine is equipped with several carburettors all the carburettors shall have the same setting.
3. SAMPLING OF GASES
- 3.1. The sampling probe shall be inserted into the exhaust pipe to a depth of at least 300 mm into the pipe connecting the exhaust with the sampling bag and as close as possible to the exhaust.

3.2. The concentration in CO (C_{CO}) and CO₂ (C_{CO_2}) shall be determined from the measuring instrument readings or recordings, by use of appropriate calibration curves.

3.3. The corrected concentration for carbon monoxide regarding four-stroke engines is:

$$C_{CO\text{ corr}} = C_{CO} \frac{15}{C_{CO} + C_{CO_2}} \quad (\text{per cent vol.})$$

3.4. The concentration in C_{CO} (see paragraph 3.2.) measured according to the formulae contained in 3.3. need not be corrected if the total of the concentrations measured ($C_{CO} + C_{CO_2}$) is for four-stroke engines at least:

- for petrol 15 per cent
- for LPG 13.5 per cent
- for NG 11.5 per cent



Annex 6

TYPE III TEST

(Verifying emissions of crankcase gases)

1. INTRODUCTION

This Annex describes the procedure for the Type III test defined in paragraph 5.3.3. of this Regulation.

2. GENERAL PROVISIONS

2.1. The Type III test shall be carried out on a vehicle with a positive-ignition engine, which has been, subjected to the Type I and the Type II test, as applicable.

2.2. The engines tested shall include leak-proof engines other than those so designed that even a slight leak may cause unacceptable operating faults (such as flat-twin engines).

3. TEST CONDITIONS

3.1. Idling shall be regulated in conformity with the manufacturer's recommendations.

3.2. The measurement shall be performed in the following three sets of conditions of engine operation:

Condition Number	Vehicle speed (km/h)
1	Idling
2	50 ± 2 (in 3rd gear or 'drive')
3	50 ± 2 (in 3rd gear or 'drive')

Condition Number	Power absorbed by the brake
1	Nil
2	That corresponding to the setting for Type I test at 50 km/h
3	That for conditions No.2, multiplied by a factor of 1.7

4. TEST METHOD

4.1. For the operation conditions as listed in paragraph 3.2. above, reliable function of the crankcase ventilation system shall be checked.

5. METHOD OF VERIFICATION OF THE CRANKCASE VENTILATION SYSTEM

- 5.1. The engine's apertures shall be left as found.
- 5.2. The pressure in the crankcase shall be measured at an appropriate location. It shall be measured at the dip stick hole with an inclined-tube manometer.
- 5.3. The vehicle shall be deemed satisfactory if, in every condition of measurement defined in paragraph 3.2. above, the pressure measured in the crankcase does not exceed the atmospheric pressure prevailing at the time of measurement.
- 5.4. For the test by the method described above, the pressure in the intake manifold shall be measured to within ± 1 kPa.
- 5.5. The vehicle speed as indicated at the dynamometer shall be measured to within ± 2 km/h.
- 5.6. The pressure measured in the crankcase shall be measured to within ± 0.01 kPa.
- 5.7. If in one of the conditions of measurement defined in paragraph 3.2. above, the pressure measured in the crankcase exceeds the atmospheric pressure, an additional test as defined in paragraph 6. below shall be performed if so requested by the manufacturer.

6. ADDITIONAL TEST METHOD

- 6.1. The engine's apertures shall be left as found.
- 6.2. A flexible bag impervious to crankcase gases and having a capacity of approximately five litres, shall be connected to the dip stick hole. The bag shall be empty before each measurement.
- 6.3. The bag shall be closed before each measurement. It shall be opened to the crankcase for five minutes for each condition of measurement prescribed in paragraph 3.2. above.
- 6.4. The vehicle shall be deemed satisfactory if, in every condition of measurement defined in paragraph 3.2. above, no visible inflation of the bag occurs.
- 6.5. Remark
 - 6.5.1. If the structural layout of the engine is such that the test cannot be performed by the methods described in paragraphs 6.1. to 6.4. above, the measurements shall be effected by that method modified as follows:

- 6.5.2. before the test, all apertures other than that required for the recovery of the gases shall be closed;
- 6.5.3. the bag shall be placed on a suitable take-off which does not introduce any additional loss of pressure and is installed on the recycling circuit of the device directly at the engine-connection aperture.

TYPE III TEST

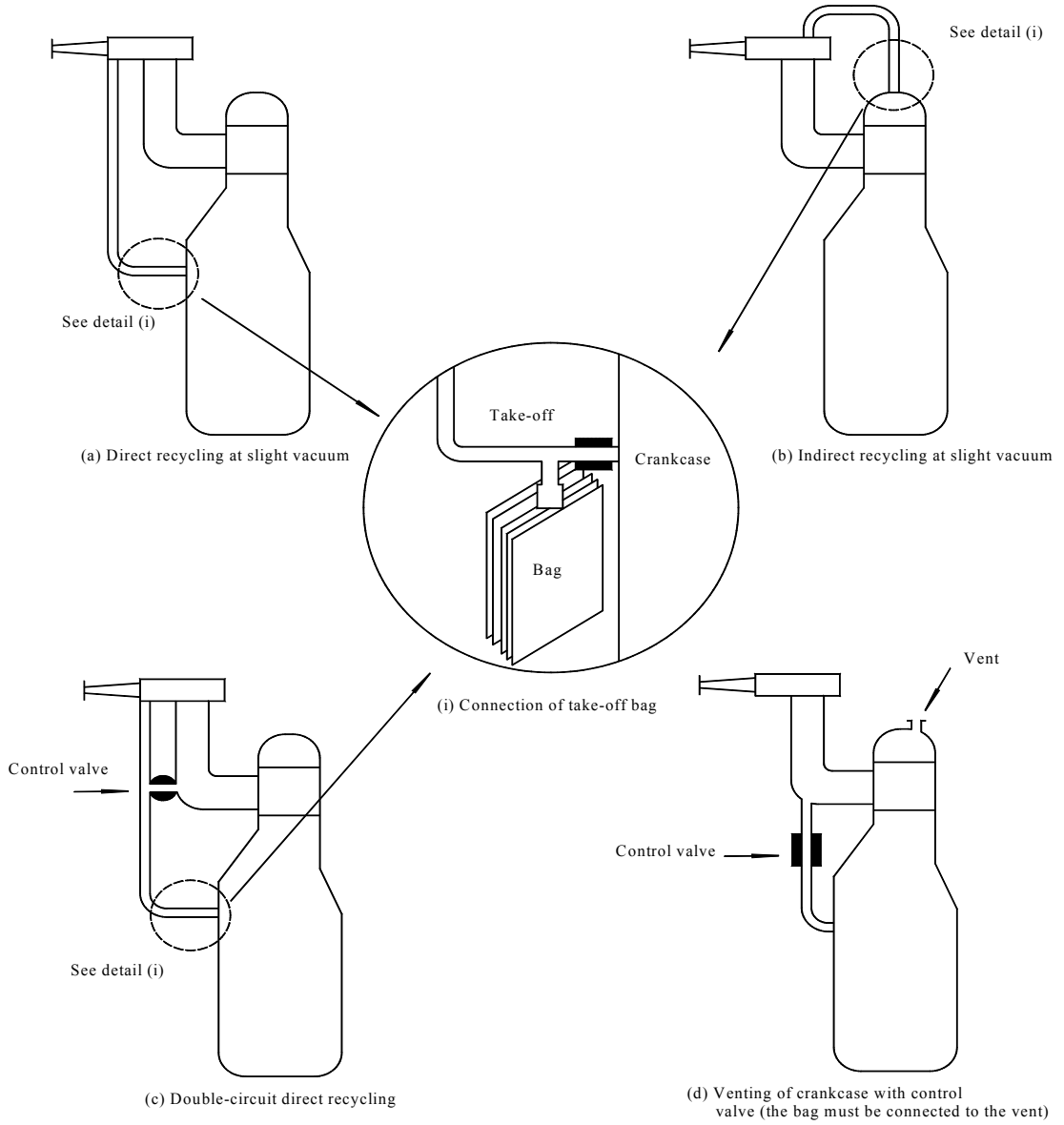

Annex 7

TYPE IV TEST

(Determination of evaporative emissions from vehicles with positive-ignition engines)

1. INTRODUCTION

This Annex describes the procedure of the Type IV test according to paragraph 5.3.4. of this Regulation.

This procedure describes a method for the determination of the loss of hydrocarbons by evaporation from the fuel systems of vehicles with positive-ignition engines.

2. DESCRIPTION OF TEST

The evaporative emissions test (Figure 7/1 below) is designed to determine hydrocarbon evaporative emissions as a consequence of diurnal temperatures fluctuation, hot soaks during parking, and urban driving. The test consists of these phases:

- 2.1. test preparation including an urban (Part One) and extra-urban (Part Two) driving cycle,
- 2.2. hot soak loss determination,
- 2.3. diurnal loss determination.

Mass emissions of hydrocarbons from the hot soak and the diurnal loss phases are added up to provide an overall result for the test.

3. VEHICLE AND FUEL

3.1. Vehicle

- 3.1.1. The vehicle shall be in good mechanical condition and have been run in and driven at least 3,000 km before the test. The evaporative emission control system shall be connected and have been functioning correctly over this period and the carbon canister(s) shall have been subject to normal use, neither undergoing abnormal purging nor abnormal loading.

3.2. Fuel

- 3.2.1. The appropriate reference fuel shall be used, as defined in Annex 10 to this Regulation.

4. TEST EQUIPMENT FOR EVAPORATIVE TEST

4.1. Chassis dynamometer

The chassis dynamometer shall meet the requirements of Annex 4.

4.2. Evaporative emission measurement enclosure

The evaporative emission measurement enclosure shall be a gas-tight rectangular measuring chamber able to contain the vehicle under test. The vehicle shall be accessible from all sides and the enclosure when sealed shall be gas-tight in accordance with Appendix 1 to this Annex. The inner surface of the enclosure shall be impermeable and non-reactive to hydrocarbons. The temperature conditioning system shall be capable of controlling the internal enclosure air temperature to follow the prescribed temperature versus time profile throughout the test, and an average tolerance of ± 1 K over the duration of the test.

The control system shall be tuned to provide a smooth temperature pattern that has a minimum of overshoot, hunting, and instability about the desired long-term ambient temperature profile. Interior surface temperatures shall not be less than 278 K (5 °C) nor more than 328 K (55 °C) at any time during the diurnal emission test.

Wall design shall be such as to promote good dissipation of heat. Interior surface temperatures shall not be below 293 K (20 °C), nor above 325 K (52 °C) for the duration of the hot soak rest.

To accommodate the volume changes due to enclosure temperature changes, either a variable-volume or fixed-volume enclosure may be used.

4.2.1. Variable-volume enclosure

The variable-volume enclosure expands and contracts in response to the temperature change of the air mass in the enclosure. Two potential means of accommodating the internal volume changes are movable panel(s), or a bellows design, in which an impermeable bag or bags inside the enclosure expand(s) and contract(s) in response to internal pressure changes by exchanging air from outside the enclosure. Any design for volume accommodation shall maintain the integrity of the enclosure as specified in Appendix 1 to this annex over the specified temperature range.

Any method of volume accommodation shall limit the differential between the enclosure internal pressure and the barometric pressure to a maximum value of + 5 kPa.

The enclosure shall be capable of latching to a fixed volume. A variable volume enclosure shall be capable of accommodating a +7 per cent change from its 'nominal volume' (see Appendix 1 to this Annex, paragraph 2.1.1.), taking into account temperature and barometric pressure variation during testing.

4.2.2. Fixed-volume enclosure

The fixed-volume enclosure shall be constructed with rigid panels that maintain a fixed enclosure volume, and meet the requirements below.

4.2.2.1. The enclosure shall be equipped with an outlet flow stream that withdraws air at a low, constant rate from the enclosure throughout the test. An inlet flow stream may provide make-up air to balance the outgoing flow with incoming ambient air. Inlet air shall be filtered with activated carbon to provide a relatively constant hydrocarbon level. Any method of volume accommodation shall maintain the differential between the enclosure internal pressure and the barometric pressure between 0 and -5 kPa.

4.2.2.2. The equipment shall be capable of measuring the mass of hydrocarbon in the inlet and outlet flow streams with a resolution of 0.01 gram. A bag sampling system may be used to collect a proportional sample of the air withdrawn from and admitted to the enclosure. Alternatively, the inlet and outlet flow streams may be continuously analysed using an on-line FID analyser and integrated with the flow measurements to provide a continuous record of the mass hydrocarbon removal.

Figure 7/1
DETERMINATION OF EVAPORATIVE EMISSIONS
 3000 km run-in period (no excessive purge/load)
 Ageing of canister(s) verified
 Steam-clean of vehicle (if necessary)

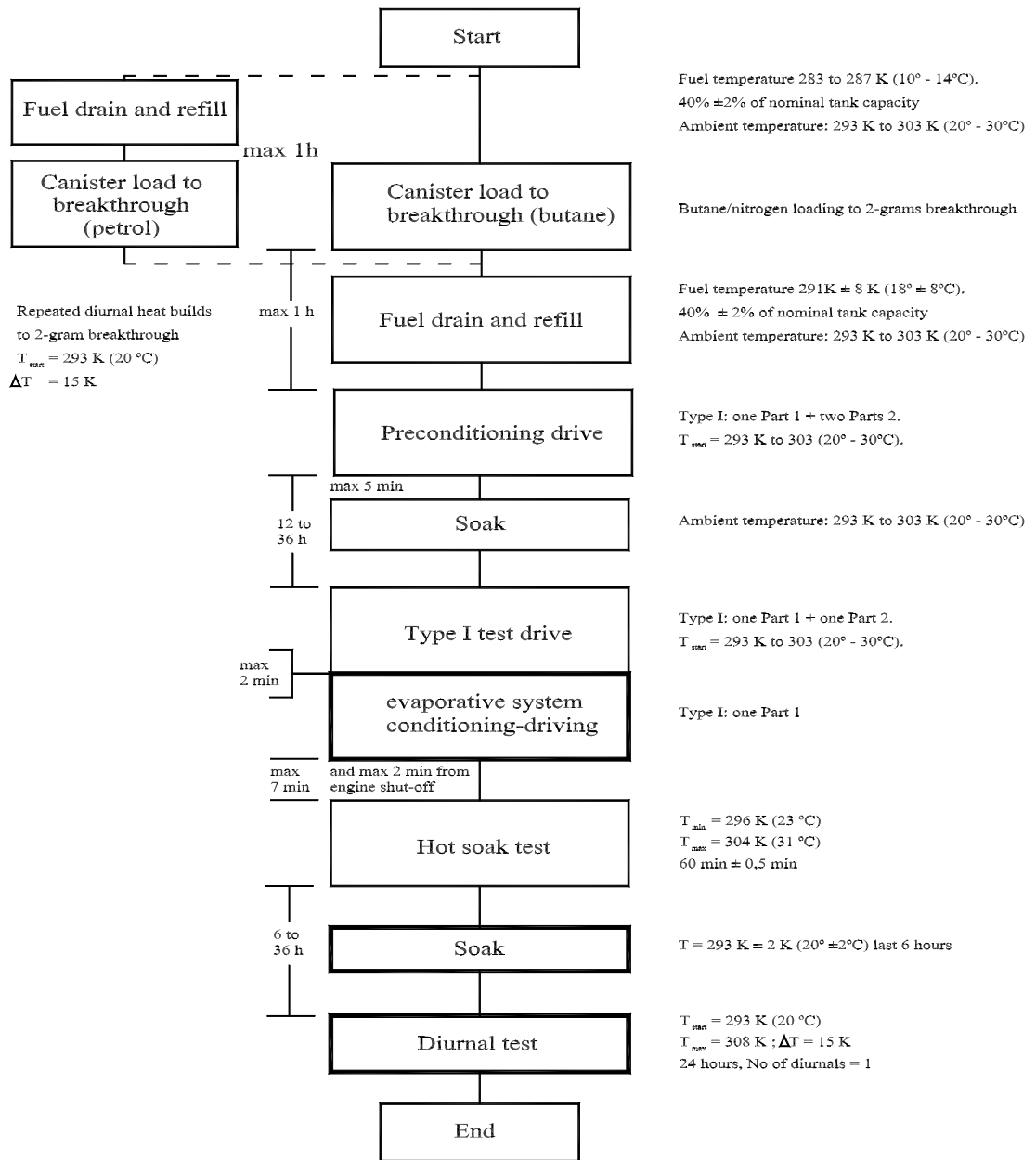

Notes:

1. Evaporative emission control families - details clarified.
2. Exhaust emissions may be measured during Type I test drive but these are not used for legislative purposes. Exhaust emission legislative test remains separate.

- 4.3. Analytical systems
- 4.3.1. Hydrocarbon analyser
- 4.3.1.1. The atmosphere within the chamber is monitored using a hydrocarbon detector of the flame ionisation detector (FID) type. Sample gas shall be drawn from the mid-point of one side wall or roof of the chamber and any bypass flow shall be returned to the enclosure, preferably to a point immediately downstream of the mixing fan.
- 4.3.1.2. The hydrocarbon analyser shall have a response time to 90 per cent of final reading of less than 1.5 seconds. Its stability shall be better than 2 per cent of full scale at zero and at 80 ± 20 per cent of full scale over a 15-minute period for all operational ranges.
- 4.3.1.3. The repeatability of the analyser expressed as one standard deviation shall be better than ± 1 per cent of full scale deflection at zero and at 80 ± 20 per cent of full scale on all ranges used.
- 4.3.1.4. The operational ranges of the analyser shall be chosen to give best resolution over the measurement, calibration and leak checking procedures.
- 4.3.2. Hydrocarbon analyser data recording system
- 4.3.2.1. The hydrocarbon analyser shall be fitted with a device to record electrical signal output either by strip chart recorder or other data processing system at a frequency of at least once per minute. The recording system shall have operating characteristics at least equivalent to the signal being recorded and shall provide a permanent record of results. The record shall show a positive indication of the beginning and end of the hot soak or diurnal emission test (including beginning and end of sampling periods along with the time elapsed between start and completion of each test).
- 4.4. Fuel tank heating (only applicable for gasoline canister load option)
- 4.4.1. The fuel in the vehicle tank(s) shall be heated by a controllable source of heat; for example a heating pad of 2,000 W capacity is suitable. The heating system shall apply heat evenly to the tank walls beneath the level of the fuel so as not to cause local overheating of the fuel. Heat shall not be applied to the vapour in the tank above the fuel.
- 4.4.2. The tank heating device shall make it possible to heat the fuel in the tank evenly by 14 K from 289 K (16 °C) within 60 minutes, with the temperature sensor position as in paragraph 5.1.1. below. The heating system shall be capable of controlling the fuel temperature to ± 1.5 K of the required temperature during the tank heating process.

4.5. Temperature recording

- 4.5.1. The temperature in the chamber is recorded at two points by temperature sensors which are connected so as to show a mean value. The measuring points are extended approximately 0.1 m into the enclosure from the vertical centre line of each side wall at a height of 0.9 ± 0.2 m.
- 4.5.2. The temperatures of the fuel tank(s) are recorded by means of the sensor positioned in the fuel tank as in paragraph 5.1.1. below in the case of use of the gasoline canister load option (paragraph 5.1.5. below).
- 4.5.3. Temperatures shall, throughout the evaporative emission measurements, be recorded or entered into a data processing system at a frequency of at least once per minute.
- 4.5.4. The accuracy of the temperature recording system shall be within ± 1.0 K and the temperature shall be capable of being resolved to ± 0.4 K.
- 4.5.5. The recording or data processing system shall be capable of resolving time to ± 15 seconds.

4.6. Pressure recording

- 4.6.1. The difference Δp between barometric pressure within the test area and the enclosure internal pressure shall, throughout the evaporative emission measurements, be recorded or entered into a data processing system at a frequency of at least once per minute.
- 4.6.2. The accuracy of the pressure recording system shall be within ± 2 kPa and the pressure shall be capable of being resolved to ± 0.2 kPa.
- 4.6.3. The recording or data processing system shall be capable of resolving time to ± 15 seconds.

4.7. Fans

- 4.7.1. By the use of one or more fans or blowers with the SHED door(s) open it shall be possible to reduce the hydrocarbons concentration in the chamber to the ambient hydrocarbon level.
- 4.7.2. The chamber shall have one or more fans or blowers of like capacity 0.1 to 0.5 m³/min. with which to thoroughly mix the atmosphere in the enclosure. It shall be possible to attain an even temperature and hydrocarbon concentration in the chamber during measurements. The vehicle in the enclosure shall not be subjected to a direct stream of air from the fans or blowers.

4.8. Gases

4.8.1. The following pure gases shall be available for calibration and operation:

Purified synthetic air: (purity: < 1 ppm C₁ equivalent, ≤ 1 ppm CO, ≤ 400 ppm CO₂, $\leq 0,1$ ppm NO); oxygen content between 18 and 21 per cent by volume,

Hydrocarbon analyser fuel gas: (40 ± 2 per cent hydrogen, and balance helium with less than 1 ppm C₁ equivalent hydrocarbon, less than 400 ppm CO₂),

Propane (C₃H₈): 99.5 per cent minimum purity,

Butane (C₄H₁₀): 98 per cent minimum purity,

Nitrogen (N₂): 98 per cent minimum purity.

4.8.2. Calibration and span gases shall be available containing mixtures of propane (C₃H₈) and purified synthetic air. The true concentrations of a calibration gas shall be within ± 2 per cent of the stated figures. The accuracy of the diluted gases obtained when using a gas divider shall be to within ± 2 per cent of the true value. The concentrations specified in Appendix 1 may also be obtained by the use of a gas divider using synthetic air as the dilutant gas.

4.9. Additional equipment

4.9.1. The absolute humidity in the test area shall be measurable to within ± 5 per cent.

5. TEST PROCEDURE

5.1. Test preparation

5.1.1. The vehicle is mechanically prepared before the test as follows:

- a) the exhaust system of the vehicle shall not exhibit any leaks,
- b) the vehicle may be steam-cleaned before the test,
- c) in the case of use of the gasoline canister load option (paragraph 5.1.5. below) the fuel tank of the vehicle shall be equipped with a temperature sensor to enable the temperature to be measured at the mid-point of the fuel in the fuel tank when filled to 40 per cent of its capacity,
- d) additional fittings, adapters or devices may be fitted to the fuel system in order to allow a complete draining of the fuel tank. For this purpose it is not necessary to modify the shell of the tank.

- e) The manufacturer may propose a test method in order to take into account the loss of hydrocarbons by evaporation coming only from the fuel system of the vehicle.

- 5.1.2. The vehicle is taken into the test area where the ambient temperature is between 293 and 303 K (20 and 30 °C).
- 5.1.3. The ageing of the canister(s) has to be verified. This may be done by demonstrating that it has accumulated a minimum of 3,000 km. If this demonstration is not given, the following procedure is used. In the case of a multiple canister system each canister shall undergo the procedure separately.
- 5.1.3.1. The canister is removed from the vehicle. Special care shall be taken during this step to avoid damage to components and the integrity of the fuel system.
- 5.1.3.2. The weight of the canister shall be checked.
- 5.1.3.3. The canister is connected to a fuel tank, possibly an external one, filled with reference fuel, to 40 per cent volume of the fuel tank(s).
- 5.1.3.4. The fuel temperature in the fuel tank shall be between 183 K and 287 K (10 and 14 °C).
- 5.1.3.5. The (external) fuel tank is heated from 288 K to 318 K (15 to 45 °C) (1 °C increase every 9 minutes).
- 5.1.3.6. If the canister reaches breakthrough before the temperature reaches 318 K (45°C), the heat source shall be turned off. Then the canister is weighed. If the canister did not reach breakthrough during the heating to 318 K (45 °C), the procedure from paragraph 5.1.3.3. above shall be repeated until breakthrough occurs.
- 5.1.3.7. Breakthrough may be checked as described in paragraphs 5.1.5. and 5.1.6. of this Annex, or with the use of another sampling and analytical arrangement capable of detecting the emission of hydrocarbons from the canister at breakthrough.
- 5.1.3.8. The canister shall be purged with 25 ± 5 litres per minute with the emission laboratory air until 300 bed volume exchanges are reached.
- 5.1.3.9. The weight of the canister shall be checked.
- 5.1.3.10. The steps of the procedure in paragraphs 5.1.3.4. to 5.1.3.9. shall be repeated nine times. The test may be terminated prior to that, after not less than three ageing cycles, if the weight of the canister after the last cycles has stabilised.
- 5.1.3.11. The evaporative emission canister is reconnected and the vehicle restored to its normal operating condition.

- 5.1.4. One of the methods specified in paragraphs 5.1.5. and 5.1.6. shall be used to precondition the evaporative canister. For vehicles with multiple canisters, each canister shall be preconditioned separately.
- 5.1.4.1. Canister emissions are measured to determine breakthrough.
- Breakthrough is here defined as the point at which the cumulative quantity of hydrocarbons emitted is equal to 2 grams.
- 5.1.4.2. Breakthrough may be verified using the evaporative emission enclosure as described in paragraphs 5.1.5. and 5.1.6. respectively. Alternatively, breakthrough may be determined using an auxiliary evaporative canister connected downstream of the vehicle's canister. The auxiliary canister shall be well purged with dry air prior to loading.
- 5.1.4.3. The measuring chamber shall be purged for several minutes immediately before the test until a stable background is obtained. The chamber air mixing fan(s) shall be switched on at this time.
- The hydrocarbon analyser shall be zeroed and spanned immediately before the test.
- 5.1.5. Canister loading with repeated heat builds to breakthrough
- 5.1.5.1. The fuel tank(s) of the vehicle(s) is (are) emptied using the fuel tank drain(s). This shall be done so as not to abnormally purge or abnormally load the evaporative control devices fitted to the vehicle. Removal of the fuel cap is normally sufficient to achieve this.
- 5.1.5.2. The fuel tank(s) is (are) refilled with test fuel at a temperature of between 283 K to 287 K (10 to 14 °C) to 40 + 2 per cent of the tank's normal volumetric capacity. The fuel cap(s) of the vehicle shall be fitted at this point.
- 5.1.5.3. Within one hour of being refuelled the vehicle shall be placed, with the engine shut off, in the evaporative emission enclosure. The fuel tank temperature sensor is connected to the temperature recording system. A heat source shall be properly positioned with respect to the fuel tank(s) and connected to the temperature controller. The heat source is specified in paragraph 4.4. above. In the case of vehicles fitted with more than one fuel tank, all the tanks shall be heated in the same way as described below. The temperatures of the tanks shall be identical to within ± 1.5 K.
- 5.1.5.4. The fuel may be artificially heated to the starting diurnal temperature of 293 K (20°C) ± 1 K.
- 5.1.5.5. When the fuel temperature reaches at least 292 K (19 °C), the following steps shall be taken immediately: the purge blower shall be turned off; enclosure doors closed and sealed; and measurement initiated of the hydrocarbon level in the enclosure.

- 5.1.5.6. When the fuel temperature of the fuel tank reaches 293 K (20 °C) a linear heat build of 15 K (15 °C) begins. The fuel shall be heated in such a way that the temperature of the fuel during the heating conforms to the function below to within ± 1.5 K. The elapsed time of the heat build and temperature rise is recorded.

$$T_r = T_o + 0.2333 \cdot t$$

where:

T_r = required temperature (K);

T_o = initial temperature (K);

t = time from start of the tank heat build in minutes.

- 5.1.5.7. As soon as break-through occurs or when the fuel temperature reaches 308 K (35°C), whichever occurs first, the heat source is turned off, the enclosure doors unsealed and opened, and the vehicle fuel tank cap(s) removed. If break-through has not occurred by the time the fuel temperature 308 K (35 °C), the heat source is removed from the vehicle, the vehicle removed from the evaporative emission enclosure and the entire procedure outlined in paragraph 5.1.7. below repeated until break-through occurs.

- 5.1.6. Butane loading to breakthrough

- 5.1.6.1. If the enclosure is used for the determination of the break-through (see paragraph 5.1.4.2. above) the vehicle shall be placed, with the engine shut off, in the evaporative emission enclosure.

- 5.1.6.2. The evaporative emission canister shall be prepared for the canister loading operation. The canister shall not be removed from the vehicle, unless access to it in its normal location is so restricted that loading can only reasonably be accomplished by removing the canister from the vehicle. Special care shall be taken during this step to avoid damage to the components and the integrity of the fuel system.

- 5.1.6.3. The canister is loaded with a mixture composed of 50 per cent butane and 50 per cent nitrogen by volume at a rate of 40 grams butane per hour.

- 5.1.6.4. As soon as the canister reaches breakthrough, the vapour source shall be shut off.

- 5.1.6.5. The evaporative emission canister shall then be reconnected and the vehicle restored to its normal operating condition.

- 5.1.7. Fuel drain and refill
- 5.1.7.1. The fuel tank(s) of the vehicle(s) is (are) emptied using the fuel tank drain(s). This shall be done so as not to abnormally purge or abnormally load the evaporative control devices fitted to the vehicle. Removal of the fuel cap is normally sufficient to achieve this.
- 5.1.7.2. The fuel tank(s) is (are) refilled with test fuel at a temperature of between $291 \pm 8 \text{ K}$ ($18 \pm 8 \text{ }^\circ\text{C}$) to $40 + 2$ per cent of the tank's normal volumetric capacity. The fuel cap(s) of the vehicle shall be fitted at this point.
- 5.2. Preconditioning drive
- 5.2.1. Within one hour from the completing of canister loading in accordance with paragraphs 5.1.5. or 5.1.6. the vehicle is placed on the chassis dynamometer and driven through one Part One and two Part Two driving cycles of Type I test as specified in Annex 4. Exhaust emissions are not sampled during this operation.
- 5.3. Soak
- 5.3.1. Within five minutes of completing the preconditioning operation specified in paragraph 5.2.1. above the engine bonnet shall be completely closed and the vehicle driven off the chassis dynamometer and parked in the soak area. The vehicle is parked for a minimum of 12 hours and a maximum of 36 hours. The engine oil and coolant temperatures shall have reached the temperature of the area or within $\pm 3 \text{ K}$ of it at the end of the period.
- 5.4. Dynamometer test
- 5.4.1. After conclusion of the soak period the vehicle is driven through a complete Type I test drive as described in Annex 4 (cold start urban and extra urban test). Then the engine is shut off. Exhaust emissions may be sampled during this operation but the results shall not be used for the purpose of exhaust emission type approval.
- 5.4.2. Within two minutes of completing the Type I test drive specified in paragraph 5.4.1. above the vehicle is driven a further conditioning drive consisting of one urban test cycle (hot start) of a Type I test. Then the engine is shut off again. Exhaust emissions need not be sampled during this operation.
- 5.5. Hot soak evaporative emissions test
- 5.5.1. Before the completion of the test run the measuring chamber shall be purged for several minutes until a stable hydrocarbon background is obtained. The enclosure mixing fan(s) shall also be turned on at this time.
- 5.5.2. The hydrocarbon analyser shall be zeroed and spanned immediately prior to the test.

- 5.5.3. At the end of the driving cycle the engine bonnet shall be completely closed and all connections between the vehicle and the test stand disconnected. The vehicle is then driven to the measuring chamber with a minimum use of the accelerator pedal. The engine shall be turned off before any part of the vehicle enters the measuring chamber. The time at which the engine is switched off is recorded on the evaporative emission measurement data recording system and temperature recording begins. The vehicle's windows and luggage compartments shall be opened at this stage, if not already opened.
- 5.5.4. The vehicle shall be pushed or otherwise moved into the measuring chamber with the engine switched off.
- 5.5.5. The enclosure doors are closed and sealed gas-tight within two minutes of the engine being switched off and within seven minutes of the end of the conditioning drive.
- 5.5.6. The start of a 60 ± 0.5 minute hot soak period begins when the chamber is sealed. The hydrocarbon concentration, temperature and barometric pressure are measured to give the initial readings $C_{H_{C_i}}$, P_i and T_i for the hot soak test. These figures are used in the evaporative emission calculation, paragraph 6. below. The ambient temperature T of the enclosure shall not be less than 296 K and no more than 304 K during the 60-minute hot soak period.
- 5.5.7. The hydrocarbon analyser shall be zeroed and spanned immediately before the end of the 60 ± 0.5 minute test period.
- 5.5.8. At the end of the 60 ± 0.5 minute test period, the hydrocarbon concentration in the chamber shall be measured. The temperature and the barometric pressure are also measured. These are the final readings $C_{H_{C_f}}$, P_f and T_f for the hot soak test used for the calculation in paragraph 6. below.
- 5.6. Soak
- 5.6.1. The test vehicle shall be pushed or otherwise moved to the soak area without use of the engine and soaked for not less than 6 hours and not more than 36 hours between the end of the hot soak test and the start of the diurnal emission test. For at least 6 hours of this period the vehicle shall be soaked at 293 ± 2 K ($20 \pm 2^\circ\text{C}$).
- 5.7. Diurnal test
- 5.7.1. The test vehicle shall be exposed to one cycle of ambient temperature according to the profile specified in Appendix 2 to this annex with a maximum deviation of ± 2 K at any time. The average temperature deviation from the profile, calculated using the absolute value of each measured deviation, shall not exceed ± 1 K. Ambient temperature shall be measured at least every minute. Temperature cycling begins when time $T_{\text{start}} = 0$, as specified in paragraph 5.7.6. below.

- 5.7.2. The measuring chamber shall be purged for several minutes immediately before the test until a stable background is obtainable. The chamber mixing fan(s) shall also be switched on at this time.
- 5.7.3. The test vehicle, with the engine shut off and the test vehicle windows and luggage compartment(s) opened shall be moved into the measuring chamber. The mixing fan(s) shall be adjusted in such a way as to maintain a minimum air circulation speed of 8 km/h under the fuel tank of the test vehicle.
- 5.7.4. The hydrocarbon analyser shall be zeroed and spanned immediately before the test.
- 5.7.5. The enclosure doors shall be closed and gas-tight sealed.
- 5.7.6. Within 10 minutes of closing and sealing the doors, the hydrocarbon concentration, temperature and barometric pressure are measured to give the initial readings $C_{HC,i}$, P_i and T_i for the diurnal test. This is the point where time $T_{start} = 0$.
- 5.7.7. The hydrocarbon analyser shall be zeroed and spanned immediately before the end of the test.
- 5.7.8. The end of the emission sampling period occurs 24 hours \pm 6 minutes after the beginning of the initial sampling, as specified in paragraph 5.7.6. above. The time elapsed is recorded. The hydrocarbon concentration, temperature and barometric pressure are measured to give the final readings $C_{HC,f}$, P_f and T_f for the diurnal test used for the calculation in paragraph 6. This completes the evaporative emission test procedure.

6. CALCULATION

- 6.1. The evaporative emission tests described in paragraph 5 allow the hydrocarbon emissions from the diurnal and hot soak phases to be calculated. Evaporative losses from each of these phases is calculated using the initial and final hydrocarbon concentrations, temperatures and pressures in the enclosure, together with the net enclosure volume. The formula below is used:

$$M_{HC} = k.V.10^{-4} \left(\frac{C_{HC,f}.P_f}{T_f} - \frac{C_{HC,i}.P_i}{T_i} \right) + M_{HC,out} - M_{HC,i}$$

where:

M_{HC} = hydrocarbon mass in grams

$M_{HC,out}$ = mass of hydrocarbon exiting the enclosure, in the case of fixed-volume enclosures for diurnal emission testing (grams).

$M_{HC,i}$ = mass of hydrocarbon entering the enclosure, in the case of fixed-volume enclosures for diurnal emission testing (grams).

- C_{HC} = measured hydrocarbon concentration in the enclosure (ppm volume in C_1 equivalent),
- V = net enclosure volume in cubic metres corrected for the volume of the vehicle, with the windows and the luggage compartment open. If the volume of the vehicle is not determined a volume of 1.42 m^3 is subtracted.
- T = ambient chamber temperature, in K,
- P = barometric pressure in kPa,
- H/C = hydrogen to carbon ratio,
- k = $1.2 \cdot (12 + H/C)$;

where:

- i = is the initial reading,
- f = is the final reading,
- H/C = is taken to be 2.33 for diurnal test losses,
- H/C = is taken to be 2.20 for hot soak losses.

6.2. Overall results of test

The overall hydrocarbon mass emission for the vehicle is taken to be:

$$M_{\text{total}} = M_{\text{DI}} + M_{\text{HS}}$$

where:

- M_{total} = overall mass emissions of the vehicle (grams),
- M_{DI} = hydrocarbon mass emission for diurnal test (grams),
- M_{HS} = hydrocarbon mass emission for the hot soak (grams).

7. CONFORMITY OF PRODUCTION

- 7.1. For routine end-of-production-line testing, the holder of the approval may demonstrate compliance by sampling vehicles which shall meet the following requirements.
- 7.2. Test for leakage
- 7.2.1. Vents to the atmosphere from the emission control system shall be isolated.
- 7.2.2. A pressure of 370 ± 10 mm of H₂O shall be applied to the fuel system.
- 7.2.3. The pressure shall be allowed to stabilise prior to isolating the fuel system from the pressure source.
- 7.2.4. Following isolation of the fuel system, the pressure shall not drop by more than 50 mm of H₂O in five minutes.
- 7.3. Test for venting
- 7.3.1. Vents to the atmosphere from the emission control shall be isolated.
- 7.3.2. A pressure of 370 ± 10 mm of H₂O shall be applied to the fuel system.
- 7.3.3. The pressure shall be allowed to stabilise prior to isolating the fuel system from the pressure source.
- 7.3.4. The venting outlets from the emission control systems to the atmosphere shall be reinstated to the production condition.
- 7.3.5. The pressure of the fuel system shall drop to below 100 mm of H₂O in not less than 30 seconds but within two minutes.
- 7.3.6. At the request of the manufacturer the functional capacity for venting can be demonstrated by equivalent alternative procedure. The specific procedure should be demonstrated by the manufacturer to the technical service during the type approval procedure.
- 7.4. Purge test
- 7.4.1. Equipment capable of detecting an airflow rate of 1.0 litres in one minute shall be attached to the purge inlet and a pressure vessel of sufficient size to have negligible effect on the purge system shall be connected via a switching valve to the purge inlet, or alternatively.
- 7.4.2. The manufacturer may use a flowmeter of his own choosing, if acceptable to the competent authority.

- 7.4.3. The vehicle shall be operated in such a manner that any design feature of the purge system that could restrict purge operation is detected and the circumstances noted.
- 7.4.4. Whilst the engine is operating within the bounds noted in paragraph 7.4.3. above, the air flow shall be determined by either:
- 7.4.4.1. the device indicated in paragraph 7.4.1. above being switched in. A pressure drop from atmospheric to a level indicating that a volume of 1.0 litres of air has flowed into the evaporative emission control system within one minute shall be observed; or
- 7.4.4.2. if an alternative flow measuring device is used, a reading of no less than 1.0 litre per minute shall be detectable.
- 7.4.4.3. At the request of the manufacturer an alternative purge test procedure can be used, if the procedure has been presented to and has been accepted by the technical service during the type approval procedure.
- 7.5. The competent authority which has granted type approval may at any time verify the conformity control methods applicable to each production unit.
- 7.5.1. The inspector shall take a sufficiently large sample from the series.
- 7.5.2. The inspector may test these vehicles by application of paragraph 8.2.5. of this Regulation.
- 7.6. If the requirements of paragraph 7.5. above are not met, the competent authority shall ensure that all necessary steps are taken to re-establish conformity of production as rapidly as possible.
-

Annex 7 - Appendix 1

CALIBRATION OF EQUIPMENT FOR EVAPORATIVE EMISSION TESTING

1. CALIBRATION FREQUENCY AND METHODS

1.1. All equipment shall be calibrated before its initial use and then calibrated as often as necessary and in any case in the month before type approval testing. The calibration methods to be used are described in this Appendix.

1.2. Normally the series of temperatures which are mentioned first shall be used. The series of temperatures within square brackets may alternatively be used.

2. CALIBRATION OF THE ENCLOSURE

2.1. Initial determination of internal volume of the enclosure

2.1.1. Before its initial use, the internal volume of the chamber shall be determined as follows:

The internal dimensions of the chamber are carefully measured, allowing for any irregularities such as bracing struts. The internal volume of the chamber is determined from these measurements.

For variable-volume enclosures, the enclosure shall be latched to a fixed volume when the enclosure is held at an ambient temperature of 303 K (30 °C) [(302 K (29 °C)]. This nominal volume shall be repeatable within ± 0.5 per cent of the reported value.

2.1.2. The net internal volume is determined by subtracting 1.42 m³ from the internal volume of the chamber. Alternatively the volume of the test vehicle with the luggage compartment and windows open may be used instead of the 1.42 m³.

2.1.3. The chamber shall be checked as in paragraph 2.3. below. If the propane mass does not correspond to the injected mass to within ± 2 per cent, then corrective action is required.

2.2. Determination of chamber background emissions

This operation determines that the chamber does not contain any materials that emit significant amounts of hydrocarbons. The check shall be carried out at the enclosure's introduction to service, after any operations in the enclosure which may affect background emissions and at a frequency of at least once per year.

- 2.2.1. Variable-volume enclosures may be operated in either latched or unlatched volume configuration, as described in paragraph 2.1.1. above, ambient temperatures shall be maintained at $308\text{ K} \pm 2\text{ K}$ ($35 \pm 2\text{ }^\circ\text{C}$) [$309\text{ K} \pm 2\text{ K}$ ($36 \pm 2\text{ }^\circ\text{C}$)], throughout the 4-hour period mentioned below.
- 2.2.2. Fixed volume enclosures shall be operated with the inlet and outlet flow streams closed. Ambient temperatures shall be maintained at $308\text{ K} \pm 2\text{ K}$ ($35 \pm 2\text{ }^\circ\text{C}$) [$309\text{ K} \pm 2\text{ K}$ ($36 \pm 2\text{ }^\circ\text{C}$)] throughout the 4-hour period mentioned below.
- 2.2.3. The enclosure may be sealed and the mixing fan operated for a period of up to 12 hours before the 4-hour background sampling period begins.
- 2.2.4. The analyser (if required) shall be calibrated, then zeroed and spanned.
- 2.2.5. The enclosure shall be purged until a stable hydrocarbon reading is obtained, and the mixing fan turned on if not already on.
- 2.2.6. The chamber is then sealed and the background hydrocarbon concentration, temperature and barometric pressure are measured. These are the initial readings C_{HCi} , P_i , T_i used in the enclosure background calculation.
- 2.2.7. The enclosure is allowed to stand undisturbed with the mixing fan on for a period of four hours.
- 2.2.8. At the end of this time the same analyser is used to measure the hydrocarbon concentration in the chamber. The temperature and the barometric pressure are also measured. These are the final readings C_{HCF} , P_f , T_f .
- 2.2.9. The change in mass of hydrocarbons in the enclosure shall be calculated over the time of the test in accordance with paragraph 2.4. below and shall not exceed 0.05g.

2.3. Calibration and hydrocarbon retention test of the chamber

The calibration and hydrocarbon retention test in the chamber provides a check on the calculated volume in paragraph 2.1. above and also measures any leak rate. The enclosure leak rate shall be determined at the enclosure's introduction to service, after any operations in the enclosure which may affect the integrity of the enclosure, and at least monthly thereafter. If six consecutive monthly retention checks are successfully completed without corrective action, the enclosure leak rate may be determined quarterly thereafter as long as no corrective action is required.

- 2.3.1. The enclosure shall be purged until a stable hydrocarbon concentration is reached. The mixing fan is turned on, if not already switched on. The hydrocarbon analyser is zeroed, calibrated if required, and spanned.
- 2.3.2. On variable-volume enclosures, the enclosure shall be latched to the nominal volume position. On fixed-volume enclosures the outlet and inlet flow streams shall be closed.
- 2.3.3. The ambient temperature control system is then turned on (if not already on) and adjusted for an initial temperature of 308 K (35 °C) [309 K (36 °C)].
- 2.3.4. When the enclosure stabilises at 308 K \pm 2 K (35 \pm 2 °C) [309 K \pm 2 K (36 \pm 2 °C)], the enclosure is sealed and the background concentration, temperature and barometric pressure measured. These are the initial readings C_{HCi} , P_i , T_i used in the enclosure calibration.
- 2.3.5. A quantity of approximately 4 grams of propane is injected into the enclosure. The mass of propane shall be measured to an accuracy and precision of \pm 2 per cent of the measured value.
- 2.3.6. The contents of the chamber shall be allowed to mix for five minutes and then the hydrocarbon concentration, temperature and barometric pressure are measured. These are the readings C_{HCf} , P_f , T_f for the calibration of the enclosure as well as the initial readings C_{HCi} , P_i , T_i for the retention check.
- 2.3.7. Based on the readings taken according to paragraphs 2.3.4. and 2.3.6. above and the formula in paragraph 2.4. below, the mass of propane in the enclosure is calculated. This shall be within \pm 2 per cent of the mass of propane measured in paragraph 2.3.5. above.
- 2.3.8. For variable-volume enclosures the enclosure shall be unlatched from the nominal volume configuration. For fixed-volume enclosures, the outlet and inlet flow streams shall be opened.
- 2.3.9. The process is then begun of cycling the ambient temperature from 308 K (35 °C) to 293 K (20 °C) and back to 308 K (35 °C) [308.6 K (35.6 °C) to 295.2 K (22.2 °C) and back to 308.6 K (35.6 °C)] over a 24-hour period according to the profile [alternative profile] specified in Appendix 2 to this annex within 15 minutes of sealing the enclosure. (Tolerances as specified in paragraph 5.7.1. of Annex 7).
- 2.3.10. At the completion of the 24-hour cycling period, the final hydrocarbon concentration, temperature and barometric pressure are measured and recorded. These are the final readings C_{HCf} , P_f , T_f for the hydrocarbon retention check.

2.3.11. Using the formula in paragraph 2.4. below, the hydrocarbon mass is then calculated from the readings taken in paragraphs 2.3.10. and 2.3.6. above. The mass may not differ by more than 3 per cent from the hydrocarbon mass given in paragraph 2.3.7. above.

2.4. Calculations

The calculation of net hydrocarbon mass change within the enclosure is used to determine the chamber's hydrocarbon background and leak rate. Initial and final readings of hydrocarbon concentration, temperature and barometric pressure are used in the following formula to calculate the mass change.

$$M_{HC} = k.V.10^{-4} \left(\frac{C_{HC,f} \cdot P_f}{T_f} - \frac{C_{HC,i} \cdot P_i}{T_i} \right) + M_{HC,out} - M_{HC,i}$$

where:

M_{HC} = hydrocarbon mass in grams,

$M_{HC,out}$ = mass of hydrocarbons exiting the enclosure, in the case of fixed-volume enclosures for diurnal emission testing (grams)

$M_{HC,i}$ = mass of hydrocarbons entering the enclosure when a fixed-volume enclosure is used for testing diurnal emissions (grams)

C_{HC} = hydrocarbon concentration in the enclosure (ppm carbon (Note: ppm carbon = ppm propane x 3),

V = enclosure volume in cubic metres,

T = ambient temperature in the enclosure, (K),

P = barometric pressure, (kPa),

K = 17.6;

where:

i is the initial reading,

f is the final reading.

3. CHECKING OF FID HYDROCARBON ANALYZER

3.1. Detector response optimisation

The FID shall be adjusted as specified by the instrument manufacturer. Propane in air should be used to optimise the response on the most common operating range.

3.2. Calibration of the HC Analyser

The analyser should be calibrated using propane in air and purified synthetic air. See paragraph 4.5.2. of Annex 4 (Calibration and span gases).

Establish a calibration curve as described in paragraphs 4.1. to 4.5. of this Appendix.

3.3. Oxygen interference check and recommended limits

The response factor (Rf) for a particular hydrocarbon species is the ratio of the FID C₁ reading to the gas cylinder concentration, expressed as ppm C₁. The concentration of the test gas shall be at a level to give a response of approximately 80 per cent of full-scale deflection, for the operating range. The concentration shall be known, to an accuracy of ± 2 per cent in reference to a gravimetric standard expressed in volume. In addition the gas cylinder shall be preconditioned for 24 hours at a temperature between 293 K and 303 K (20 and 30 °C).

Response factors should be determined when introducing an analyser into service and thereafter at major service intervals. The reference gas to be used is propane with balance purified air which is taken to give a response factor of 1.00.

The test gas to be used for oxygen interference and the recommended response factor range are given below:

Propane and nitrogen: $0.95 \leq Rf \leq 1.05$.

4. CALIBRATION OF THE HYDROCARBON ANALYZER

Each of the normally used operating ranges are calibrated by the following procedure:

4.1. establish the calibration curve by at least five calibration points spaced as evenly as possible over the operating range. The nominal concentration of the calibration gas with the highest concentrations to be at least 80 per cent of the full scale.

- 4.2. calculate the calibration curve by the method of least squares. If the resulting polynomial degree is greater than 3, then the number of calibration points shall be at least the number of the polynomial degree plus 2.
- 4.3. the calibration curve shall not differ by more than 2 per cent from the nominal value of each calibration gas.
- 4.4. Using the coefficients of the polynomial derived from paragraph 3.2. above, a table of indicated reading against true concentration shall be drawn up in steps of no greater than 1 per cent of full scale. This is to be carried out for each analyser range calibrated. The table shall also contain other relevant data such as:
- a) date of calibration, span and zero potentiometer readings (where applicable),
 - b) nominal scale,
 - c) reference data of each calibration gas used,
 - d) the actual and indicated value of each calibration gas used together with the percentage differences,
 - e) FID fuel and type,
 - f) FID air pressure.
- 4.5. If it can be shown to the satisfaction of the technical service that alternative technology (e.g. computer, electronically controlled range switch) can give equivalent accuracy, then those alternatives may be used.
-

Annex 7 - Appendix 2

Diurnal ambient temperature profile for the calibration of the enclosure and the diurnal emission test			Alternative diurnal ambient temperature profile for the calibration of the enclosure in accordance with Annex 7, Appendix 1, paragraphs 1.2. and 2.3.9.	
Time (hours)		Temperature (°C _i)	Time (hours)	Temperature (°C _i)
Calibration	Test			
13	0/24	20.0	0	35.6
14	1	20.2	1	35.3
15	2	20.5	2	34.5
16	3	21.2	3	33.2
17	4	23.1	4	31.4
18	5	25.1	5	29.7
19	6	27.2	6	28.2
20	7	29.8	7	27.2
21	8	31.8	8	26.1
22	9	33.3	9	25.1
23	10	34.4	10	24.3
24/0	11	35.0	11	23.7
1	12	34.7	12	23.3
2	13	33.8	13	22.9
3	14	32.0	14	22.6
4	15	30.0	15	22.2
5	16	28.4	16	22.5
6	17	26.9	17	24.2
7	18	25.2	18	26.8
8	19	24.0	19	29.6
9	20	23.0	20	31.9
10	21	22.0	21	33.9
11	22	20.8	22	35.1
12	23	20.2	23	35.4
			24	35.6

Annex 8

TYPE VI TEST

(Verifying the average exhaust emissions of carbon monoxide and hydrocarbons after a cold start at low ambient temperature)

1. INTRODUCTION

This Annex applies only to vehicles with positive-ignition engines. It describes the equipment required and the procedure for the Type VI test defined in paragraph 5.3.5 of this Regulation in order to verify the emissions of carbon monoxide and hydrocarbons at low ambient temperatures. Topics addressed in this Regulation include:

- i. equipment requirements;
- ii. test conditions;
- iii. test procedures and data requirements.

2. TEST EQUIPMENT

2.1. Summary

2.1.1. This chapter deals with the equipment needed for low ambient temperature exhaust emission tests of positive-ignition engined vehicles. Equipment required and specifications are equivalent to the requirements for the Type I test as specified in Annex 4, with appendices, if specific requirements for the Type VI test are not prescribed. Paragraphs 2.2. to 2.6. describe deviations applicable to Type VI low ambient temperature testing.

2.2. Chassis dynamometer

2.2.1. The requirements of paragraph 4.1. of Annex 4 apply. The dynamometer shall be adjusted to simulate the operation of a vehicle on the road at 266 K (−7 °C). Such adjustment may be based on a determination of the road load force profile at 266 K (−7 °C). Alternatively the driving resistance determined according to Appendix 3 of Annex 4 may be adjusted for a 10 per cent decrease of the coast-down time. The technical service may approve the use of other methods of determining the driving resistance.

2.2.2. For calibration of the dynamometer the provisions of Appendix 2 to Annex 4 apply.

2.3. Sampling system

2.3.1. The provisions of paragraph 4.2. of Annex 4 and Appendix 5 to Annex 4 apply. Paragraph 2.3.2. of Appendix 5 is modified to read:

"The piping configuration, flow capacity of the CVS, and the temperature and specific humidity of the dilution air (which may be different from the vehicle combustion air source) shall be controlled so as to virtually eliminate water condensation in the system (a flow of 0.142 to 0.165 m³/s is sufficient for most vehicles)."

2.4. Analytical equipment

2.4.1. The provisions of paragraph 4.3. of Annex 4 apply, but only for carbon monoxide, carbon dioxide, and hydrocarbon testing.

2.4.2. For calibrations of the analytical equipment the provisions of Appendix 6 to Annex 4 apply.

2.5. Gases

2.5.1. The provisions of paragraph 4.5. of Annex 4 apply, where they are relevant.

2.6. Additional equipment

2.6.1. For equipment used for the measurement of volume, temperature, pressure and humidity the provisions in paragraphs 4.4. and 4.6. of Annex 4 apply.

3. TEST SEQUENCE AND FUEL

3.1. General requirements

3.1.1. The test sequence in Figure 8/1 shows the steps encountered as the test vehicle undergoes the procedures for the Type VI test. Ambient temperature levels encountered by the test vehicle shall average: 266 K (−7 °C) ± 3 K and shall not be less than 260 K (−13 °C), or more than 272 K (−1 °C).

The temperature may not fall below 263 K (−10 °C), or exceed 269 K (−4 °C) for more than three consecutive minutes.

3.1.2. The test cell temperature monitored during testing shall be measured at the output of the cooling fan (paragraph 5.2.1. of this Annex). The ambient temperature reported shall be an arithmetic average of the test cell temperatures measured at constant intervals no more than one minute apart.

3.2. Test procedure

The Part One urban driving cycle according to Figure 1/1 in Annex 4, Appendix 1, consists of four elementary urban cycles which together make a complete Part One cycle.

3.2.1. Start of engine, start of the sampling and the operation of the first cycle shall be in accordance with Table 1.2 and Figure 1/1 in Annex 4.

3.3. Preparation for the test

3.3.1. For the test vehicle the provisions of paragraph 3.1. of Annex 4 apply. For setting the equivalent inertia mass on the dynamometer the provisions of paragraph 5.1. of Annex 4 apply.

Figure 8/1

Procedure for low ambient temperature test

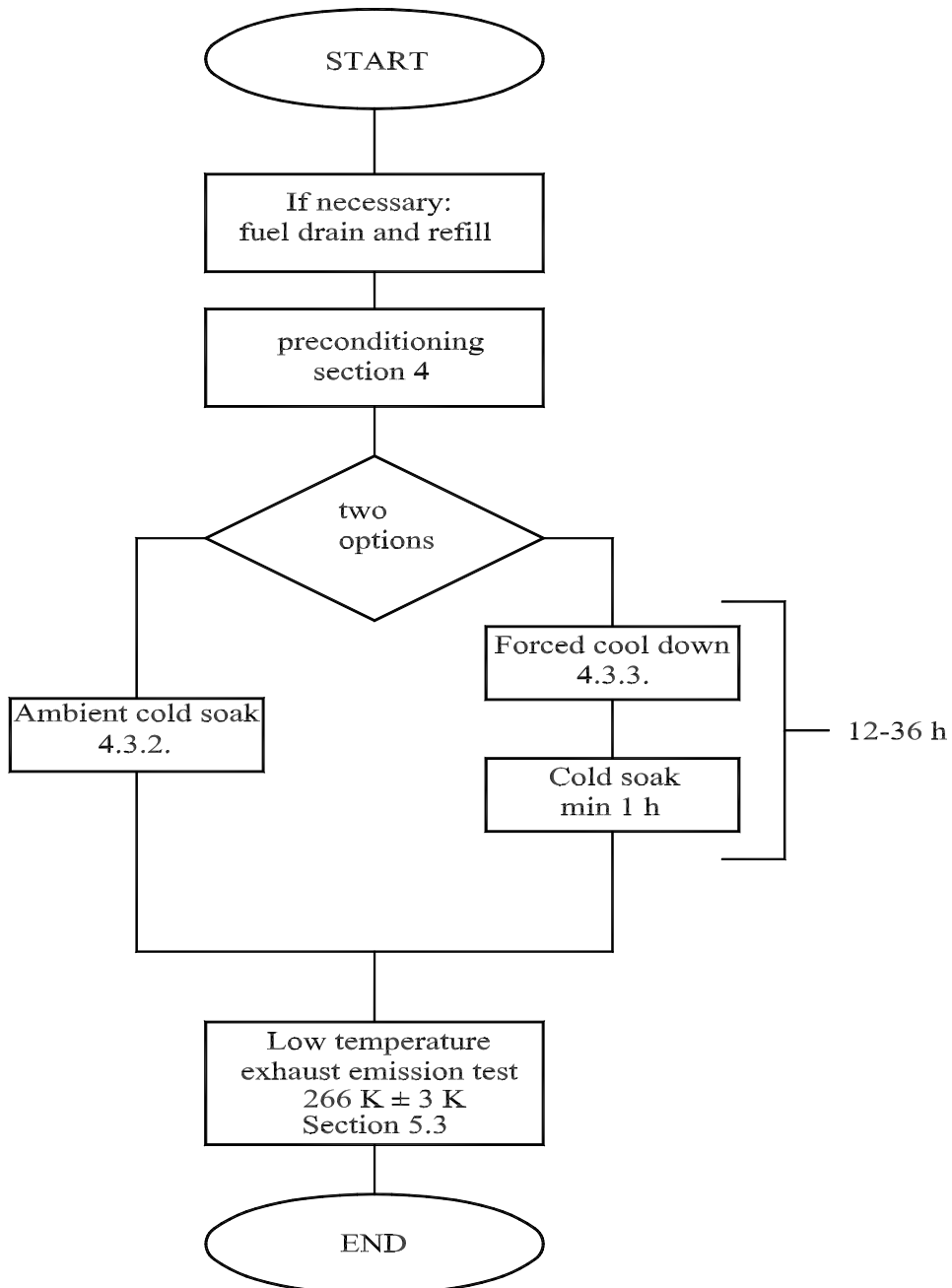

3.4. Test fuel

3.4.1. The test fuel must comply with the specifications given in paragraph 3. of Annex 10.

4. VEHICLE PRECONDITIONING

4.1. Summary

4.1.1. To ensure reproducible emission tests, the test vehicles shall be conditioned in a uniform manner. The conditioning consists of a preparatory drive on a chassis dynamometer followed by a soak period before the emission test according to paragraph 4.3.

4.2. Preconditioning

4.2.1. The fuel tank(s) shall be filled with the specified test fuel. If the existing fuel in the fuel tank(s) does not meet the specifications contained in paragraph 3.4.1. above, the existing fuel shall be drained prior to the fuel fill. The test fuel shall be at a temperature less than or equal to 289 K (+ 16 °C). For the above operations the evaporative emission control system shall neither be abnormally purged nor abnormally loaded.

4.2.2. The vehicle is moved to the test cell and placed on the chassis dynamometer.

4.2.3. The preconditioning consists of the driving cycle according to Annex 4, Appendix 1, Figure 1/1, Parts One and Two. At the request of the manufacturer, vehicles with a positive-ignition engine may be preconditioned with one Part One and two Part Two driving cycles.

4.2.4. During the preconditioning the test cell temperature shall remain relatively constant and not be higher than 303 K (30 °C).

4.2.5. The drive-wheel tyre pressure shall be set in accordance with the provisions of paragraph 5.3.2 of Annex 4.

4.2.6. Within ten minutes of completion of the preconditioning, the engine shall be switched off.

4.2.7. If requested by the manufacturer and approved by the technical service, additional preconditioning may in exceptional cases be allowed. The technical service may also choose to conduct additional preconditioning. The additional preconditioning consists of one or more driving schedules of the Part One cycle as described in Annex 4, Appendix 1. The extent of such additional preconditioning shall be recorded in the test report.

4.3. Soak methods

4.3.1. One of the following two methods, to be selected by the manufacturer, shall be utilised to stabilise the vehicle before the emission test.

4.3.2. Standard method

The vehicle is stored for not less than 12 hours nor for more than 36 hours prior to the low ambient temperature exhaust emission test. The ambient temperature (dry bulb) during this period shall be maintained at an average temperature of:

266 K ($-7\text{ }^{\circ}\text{C}$) \pm 3 K during each hour of this period and shall not be less than 260 K ($-13\text{ }^{\circ}\text{C}$) nor more than 272 K ($-1\text{ }^{\circ}\text{C}$). In addition, the temperature may not fall below 263 K ($-10\text{ }^{\circ}\text{C}$) nor more than 269 K ($-4\text{ }^{\circ}\text{C}$) for more than three consecutive minutes.

4.3.3. Forced method

The vehicle shall be stored for not more than 36 hours prior to the low ambient temperature exhaust emission test.

4.3.3.1. The vehicle shall not be stored at ambient temperatures which exceed 303 K ($30\text{ }^{\circ}\text{C}$) during this period.

4.3.3.2. Vehicle cooling may be accomplished by force-cooling the vehicle to the test temperature. If cooling is augmented by fans, the fans shall be placed in a vertical position so that the maximum cooling of the drive train and engine is achieved and not primarily the sump. Fans shall not be placed under the vehicle.

4.3.3.3. The ambient temperature need only be stringently controlled after the vehicle has been cooled to 266 K ($-7\text{ }^{\circ}\text{C}$) \pm 2 K, as determined by a representative bulk oil temperature.

A representative bulk oil temperature is the temperature of the oil measured near the middle of the oil sump, not at the surface or at the bottom of the oil sump. If two or more diverse locations in the oil are monitored, they shall all meet the temperature requirements.

4.3.3.4. The vehicle shall be stored for at least one hour after it has been cooled to 266 K ($-7\text{ }^{\circ}\text{C}$) \pm 2 K, prior to the low ambient temperature exhaust emission test. The ambient temperature (dry bulb) during this period shall average 266 K ($-7\text{ }^{\circ}\text{C}$) \pm 3 K, and shall not be less than 260 K ($-13\text{ }^{\circ}\text{C}$) or more than 272 K ($-1\text{ }^{\circ}\text{C}$),

In addition, the temperature may not fall below 263 K (−10 °C) or exceed 269 K (−4 °C), for more than three consecutive minutes.

- 4.3.4. If the vehicle is stabilised at 266 K (−7 °C), in a separate area and is moved through a warm area to the test cell, the vehicle shall be destabilised in the test cell for at least six times the period the vehicle is exposed to warmer temperatures. The ambient temperature (dry bulb) during this period shall average 266 K (−7 °C) ± 3 K and shall not be less than 260 K (−13 °C) nor more than 272 K (−1 °C).

In addition, the temperature may not fall below 263 K (−10 °C) or exceed 269 K (−4 °C), for more than three consecutive minutes.

5. DYNAMOMETER PROCEDURE

5.1. Summary

- 5.1.1. The emission sampling is performed over a test procedure consisting of the Part One cycle (Annex 4, Appendix 1, Figure 1/1). Engine start-up, immediate sampling, operation over the Part One cycle and engine shut-down make a complete low ambient temperature test, with a total test time of 780 seconds. The exhaust emissions are diluted with ambient air and a continuously proportional sample is collected for analysis. The exhaust gases collected in the bag are analysed for hydrocarbons, carbon monoxide, and carbon dioxide. A parallel sample of the dilution air is similarly analysed for carbon monoxide, hydrocarbons and carbon dioxide.

5.2. Dynamometer operation

5.2.1. Cooling fan

- 5.2.1.1. A cooling fan is positioned so that cooling air is appropriately directed to the radiator (water cooling) or to the air intake (air-cooling) and to the vehicle.
- 5.2.1.2. For front-engined vehicles, the fan shall be positioned in front of the vehicle, within 300 mm of it. In the case of rear-engined vehicles or if the above arrangement is impractical, the cooling fan shall be positioned so that sufficient air is supplied to cool the vehicle.

- 5.2.1.3. The fan speed shall be such that, within the operating range of 10 km/h to at least 50 km/h, the linear velocity of the air at the blower outlet is within ± 5 km/h of the corresponding roller speed. The final selection of the blower shall have the following characteristics:
- i. area: at least 0.2 m^2 ,
 - ii. height of the lower edge above ground: approximately 20 cm.

As an alternative the blower linear air speed shall be at least 6 m/s (21.6 km/h). At the request of the manufacturer, for special vehicles (e.g. vans, off-road) the height of the cooling fan may be modified.

- 5.2.1.4. The vehicle speed as measured from the dynamometer roll(s) shall be used (paragraph 4.1.4.4. of Annex 4).
- 5.2.3. Preliminary testing cycles may be carried out if necessary, to determine how best to actuate the accelerator and brake controls so as to achieve a cycle approximating to the theoretical cycle within the prescribed limits, or to permit sampling system adjustment. Such driving shall be carried out before "START" according to Figure 8/1.
- 5.2.4. Humidity in the air shall be kept low enough to prevent condensation on the dynamometer roll(s).
- 5.2.5. The dynamometer shall be thoroughly warmed as recommended by the dynamometer manufacturer, and using procedures or control methods that assure stability of the residual frictional power.
- 5.2.6. The time between dynamometer warming and the start of the emission test shall be no longer than 10 minutes if the dynamometer bearings are not independently heated. If the dynamometer bearings are independently heated, the emission test shall begin no longer than 20 minutes after dynamometer warming.
- 5.2.7. If the dynamometer power is to be adjusted manually, it shall be set within one hour prior to the exhaust emission test phase. The test vehicle may not be used to make the adjustment. The dynamometer, using automatic control of pre-selectable power settings, may be set at any time prior to the beginning of the emission test.
- 5.2.8. Before the emission test driving schedule may begin, the test cell temperature shall be $266 \text{ K } (-7 \text{ }^\circ\text{C}) \pm 2 \text{ K}$, as measured in the air stream of the cooling fan with a maximum distance of 1.5 m from the vehicle.
- 5.2.9. During operation of the vehicle the heating and defrosting devices shall be shut off.

- 5.2.10. The total driving distance or roller revolutions measured are recorded.
- 5.2.11. A four-wheel drive vehicle shall be tested in a two-wheel drive mode of operation. The determination of the total road force for dynamometer setting is performed while operating the vehicle in its primary designed driving mode.

5.3. Performing the test

- 5.3.1. The provisions of paragraphs 6.2. to 6.6., excluding 6.2.2., of Annex 4 apply in respect of starting the engine, carrying out the test and taking the emission samples. The sampling begins before or at the initiation of the engine start-up procedure and ends on conclusion of the final idling period of the last elementary cycle of the Part One (urban driving cycle), after 780 seconds.

The first driving cycle starts with a period of 11 seconds idling as soon as the engine has started.

- 5.3.2. For the analysis of the sampled emissions the provisions of paragraph 7.2. of Annex 4 apply. In performing the exhaust sample analysis the technical service shall exercise care to prevent condensation of water vapour in the exhaust gas sampling bags.
- 5.3.3. For the calculations of the mass emissions the provisions of paragraph 8 of Annex 4 apply.

6. OTHER REQUIREMENTS

6.1. Irrational emission control strategy

- 6.1.1. Any irrational emission control strategy which results in a reduction in effectiveness of the emission control system under normal operating conditions at low temperature driving, so far as not covered by the standardised emission tests, may be considered a defeat device.

Annex 9

TYPE V TEST

(Description of the endurance test for verifying the durability of pollution control devices)

1. INTRODUCTION

This Annex describes the test for verifying the durability of anti-pollution devices equipping vehicles with positive-ignition or compression-ignition engines during an ageing test of 80,000 km.

2. TEST VEHICLE

- 2.1. The vehicle shall be in good mechanical order; the engine and the anti-pollution devices shall be new. The vehicle may be the same as that presented for the Type I test; this Type I test has to be done after the vehicle has run at least 3,000 km of the ageing cycle of paragraph 5.1. below.

3. FUEL

The durability test is conducted with a suitable commercially available fuel.

4. VEHICLE MAINTENANCE AND ADJUSTMENTS

Maintenance, adjustments as well as the use of the test vehicle's controls shall be those recommended by the manufacturer.

5. VEHICLE OPERATION ON TRACK, ROAD OR ON CHASSIS DYNAMOMETER

5.1. Operating cycle

During operation on track, road or on roller test bench, the distance shall be covered according to the driving schedule (Figure 9/1) described below:

- 5.1.1. the durability test schedule is composed of 11 cycles covering 6 kilometres each,
- 5.1.2. during the first nine cycles, the vehicle is stopped four times in the middle of the cycle, with the engine idling each time for 15 seconds,
- 5.1.3. normal acceleration and deceleration,

- 5.1.4. five decelerations in the middle of each cycle, dropping from cycle speed to 32 km/h, and the vehicle is gradually accelerated again until cycle speed is attained,
- 5.1.5. the 10th cycle is carried out at a steady speed of 89 km/h,
- 5.1.6. the 11th cycle begins with maximum acceleration from stop point up to 113 km/h. At half-way, braking is employed normally until the vehicle comes to a stop. This is followed by an idle period of 15 seconds and a second maximum acceleration.

The schedule is then restarted from the beginning.

The maximum speed of each cycle is given in the following table.

Table 9.1.
Maximum speed of each cycle

Cycle	Cycle speed in km/h
1	64
2	48
3	64
4	64
5	56
6	48
7	56
8	72
9	56
10	89
11	113

Figure 9/1

Driving schedule

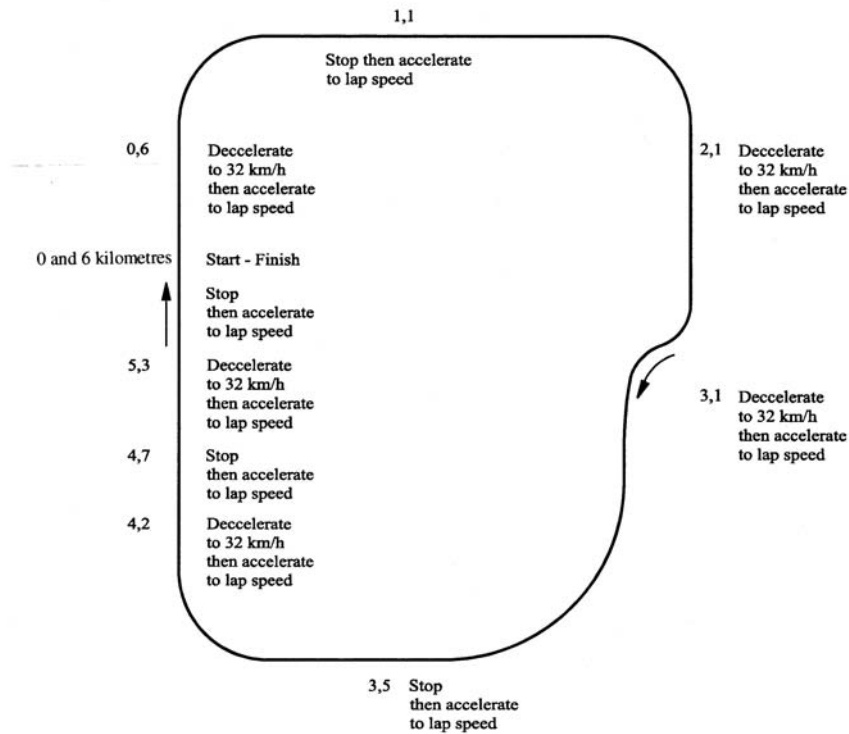

- 5.2 At the request of the manufacturer, an alternative road test schedule may be used. Such alternative test schedules shall be approved by the technical service in advance of the test and shall have substantially the same average speed, distribution of speeds, number of stops per kilometres and number of accelerations per kilometres as the driving schedule used on track or roller test bench, as detailed in paragraph 5.1. and Figure 9/1.
- 5.3. The durability test, or if the manufacturer has chosen, the modified durability test shall be conducted until the vehicle has covered a minimum of 80,000 km.
- 5.4. Test equipment
- 5.4.1. Chassis dynamometer

- 5.4.1.1. When the durability test is performed on a chassis dynamometer, the dynamometer shall enable the cycle described in paragraph 5.1. to be carried out. In particular, it shall be equipped with systems simulating inertia and resistance to progress.
- 5.4.1.2. The brake shall be adjusted in order to absorb the power exerted on the driving wheels at a steady speed of 80 km/h. Methods to be applied to determine this power and to adjust the brake are the same as those described in Appendix 3 to Annex 4.
- 5.4.1.3. The vehicle cooling system should enable the vehicle to operate at temperatures similar to those obtained on road (oil, water, exhaust system, etc.).
- 5.4.1.4. Certain other test bench adjustments and features are deemed to be identical, where necessary, to those described in Annex 4 of this Regulation (inertia, for example, which may be mechanical or electronic).
- 5.4.1.5. The vehicle may be moved, where necessary, to a different bench in order to conduct emission measurement tests.
- 5.4.2. Operation on track or road

When the durability test is completed on track or road, the vehicle's reference mass will be at least equal to that retained for tests conducted on a chassis dynamometer.

6. MEASURING EMISSIONS OF POLLUTANTS

At the start of the test (0 km), and every 10,000 km (\pm 400 km) or more frequently, at regular intervals until having covered 80,000 km, exhaust emissions are measured in accordance with the Type I test as defined in paragraph 5.3.1. of this Regulation. The limit values to be complied with are those laid down in paragraph 5.3.1.4. of this Regulation.

In the case of vehicles equipped with periodically regenerating systems as defined in paragraph 2.20. of this Regulation, it shall be checked that the vehicle is not approaching a regeneration period. If this is the case, the vehicle must be driven until the end of the regeneration. If a regeneration occurs during the emissions measurement, a new test (including preconditioning) shall be performed, and the first result not taken into account.

All exhaust emissions results shall be plotted as a function of the running distance on the system rounded to the nearest kilometre and the best fit straight line fitted by the method of least squares shall be drawn through all these data points. This calculation shall not take into account the test results at 0 km.

The data will be acceptable for use in the calculation of the deterioration factor only if the interpolated 6,400 km and 80,000 km points on this line are within the above mentioned limits.

The data are still acceptable when a best fit straight line crosses an applicable limit with a negative slope (the 6,400 km interpolated point is higher than the 80,000 km interpolated point) but the 80,000 km actual data point is below the limit.

A multiplicative exhaust emission deterioration factor shall be calculated for each pollutant as follows:

$$\text{D.E.F.} = \frac{M_{i2}}{M_{i1}}$$

where:

M_{i1} = mass emission of the pollutant i in g/km interpolated to 6,400 km,

M_{i2} = mass emission of the pollutant i in g/km interpolated to 80,000 km.

These interpolated values shall be carried out to a minimum of four places to the right of the decimal point before dividing one by the other to determine the deterioration factor. The result shall be rounded to three places to the right of the decimal point.

If a deterioration factor is less than one, it is deemed to be equal to one.

Annex 10

1. SPECIFICATIONS OF REFERENCE FUELS
FOR TESTING VEHICLES TO THE EMISSION LIMITS GIVEN IN ROW
A OF THE TABLE IN PARAGRAPH 5.3.1.4. – TYPE I TEST

1.1. TECHNICAL DATA ON THE REFERENCE FUEL TO BE USED FOR
TESTING VEHICLES EQUIPPED WITH POSITIVE-IGNITION ENGINES

Type: Unleaded petrol

Parameter	Unit	Limits ^{1/}		Test Method
		minimum	maximum	
Research octane number, RON		95.0	-	EN 25164
Motor octane number, MON		85.0	-	EN 25163
Density at 15 °C	kg/m ³	748	762	ISO 3675
Reid vapour pressure	kPa	56.0	60.0	EN 12
Distillation:				
- initial boiling point	°C	24	40	EN-ISO 3405
- evaporated at 100 °C	per cent v/v	49.0	57.0	EN-ISO 3405
- evaporated at 150 °C	per cent v/v	81.0	87.0	EN-ISO 3405
- final boiling point	°C	190	215	EN-ISO 3405
Residue	per cent v/v	-	2	EN-ISO 3405
Hydrocarbon analysis:				
- olefins	per cent v/v	-	10	ASTM D 1319
- aromatics	per cent v/v	28.0	40.0	ASTM D 1319
- benzene	per cent v/v	-	1.0	pr. EN 12177
- saturates	per cent v/v	-	balance	ASTM D 1319
Carbon/hydrogen ratio		report	report	
Induction period ^{2/}	min.	480	-	EN-ISO 7536
Oxygen content	per cent m/m	-	2.3	EN 1601
Existent gum	mg/ml	-	0.04	EN-ISO 6246
Sulphur content ^{3/}	mg/kg	-	100	pr. EN ISO/DIS 14596
Class I copper corrosion		-	1	EN-ISO 2160
Lead content	mg/l	-	5	EN 237
Phosphorus content	mg/l	-	1.3	ASTM D 3231

^{1/} The values quoted in the specifications are “true values”. In establishment of their limit values the terms of ISO 4259 “Petroleum products – Determination and application of precision data in relation to methods of test” have been applied and in fixing a minimum value, a minimum difference of 2R above zero has been taken into account; in fixing a maximum and minimum value, the minimum difference is 4R (R = reproducibility).

Notwithstanding this measure, which is necessary for technical reasons, the manufacturer of fuels should nevertheless aim at a zero value where the stipulated maximum value is 2R and at the mean value in the case of quotations of maximum and minimum limits. Should it be necessary to clarify the questions as to whether a fuel meets the requirements of the specifications, the terms of ISO 4259 should be applied.

^{2/} The fuel may contain oxidation inhibitors and metal deactivators normally used to stabilise refinery gasoline streams, but detergent/dispersive additives and solvent oils must not be added.

^{3/} The actual sulphur content of the fuel used for the Type I test shall be reported.

1.2. TECHNICAL DATA ON THE REFERENCE FUEL TO BE USED FOR TESTING VEHICLES EQUIPPED WITH DIESEL ENGINES

Type: Diesel fuel

Parameter	Unit	Limits ^{1/}		Test Method
		minimum	maximum	
Cetane number ^{2/}		52.0	54.0	EN-ISO 5165
Density at 15 °C	kg/m ³	833	837	EN-ISO 3675
Distillation:				
50 per cent point	°C	245	-	EN-ISO 3405
95 per cent point	°C	345	350	EN-ISO 3405
- final boiling point	°C	-	370	EN-ISO 3405
Flash point	°C	55	-	EN 22719
CFPP	°C	-	-5	EN 116
Viscosity at 40 °C	mm ² /s	2.5	3.5	EN-ISO 3104
Polycyclic aromatic hydrocarbons	per cent m/m	3	6.0	IP 391
Sulphur content ^{3/}	mg/kg	-	300	Pr. EN-ISO/DIS 14596
Copper corrosion		-	1	EN-ISO 2160
Conradson carbon residue (10 per cent DR)	per cent m/m	-	0.2	EN-ISO 10370
Ash content	per cent m/m	-	0.01	EN-ISO 6245
Water content	per cent m/m	-	0.02	EN-ISO 12937
Neutralisation (strong acid) number	mg KOH/g	-	0.02	ASTM D 974-95
Oxidation stability ^{4/}	mg/ml	-	0.025	EN-ISO 12205
New and better method for poly-cyclic aromatics under development	per cent m/m	-	-	EN 12916

^{1/} The values quoted in the specifications are “true values”. In establishment of their limit values the terms of ISO 4259 “Petroleum products – Determination and application of precision data in relation to methods of test” have been applied and in fixing a minimum value, a minimum difference of 2R above zero has been taken into account; in fixing a maximum and minimum value, the minimum difference is 4R (R = reproducibility).

Notwithstanding this measure, which is necessary for technical reasons, the manufacturer of fuels should nevertheless aim at a zero value where the stipulated maximum value is 2R and at the mean value in the case of quotations of maximum and minimum limits. Should it be necessary to clarify the questions as to whether a fuel meets the requirements of the specifications, the terms of ISO 4259 should be applied.

^{2/} The range for cetane number is not in accordance with the requirements of a minimum range of 4R. However, in the case of a dispute between fuel supplier and fuel user, the terms of ISO 4259 may be used to resolve such disputes provided replicate measurements, of sufficient number to achieve the necessary precision, are made in preference to single determinations.

^{3/} The actual sulphur content of the fuel used for the Type I test shall be reported.

^{4/} Even though oxidation stability is controlled, it is likely that shelf life will be limited. Advice should be sought from the supplier as to storage conditions and life.

2. SPECIFICATIONS OF REFERENCE FUELS
FOR TESTING VEHICLES TO THE EMISSION LIMITS GIVEN IN ROW
B OF THE TABLE IN PARAGRAPH 5.3.1.4. – TYPE I TEST

2.1. TECHNICAL DATA ON THE REFERENCE FUEL TO BE USED FOR
TESTING VEHICLES EQUIPPED WITH POSITIVE-IGNITION ENGINES

Type: Unleaded petrol

Parameter	Unit	Limits ^{1/}		Test Method
		minimum	maximum	
Research octane number, RON		95.0	-	EN 25164
Motor octane number, MON		85.0	-	EN 25163
Density at 15 °C	kg/m ³	740	754	ISO 3675
Reid vapour pressure	kPa	56.0	60.0	PrEN ISO 13016-1 (DVPE)
Distillation:				
- Evaporated at 70 °C	per cent v/v	24.0	40.0	EN-ISO 3405
- Evaporated at 100 °C	per cent v/v	50.0	58.0	EN-ISO 3405
- Evaporated at 150 °C	per cent v/v	83.0	89.0	EN-ISO 3405
- final boiling point	°C	190	210	EN-ISO 3405
Residue	per cent v/v	-	2.0	EN-ISO 3405
Hydrocarbon analysis:				
Olefins	per cent v/v	-	10.0	ASTM D 1319
Aromatics	per cent v/v	29.0	35.0	ASTM D 1319
Saturates	per cent v/v	Report		ASTM D 1319
Benzene	per cent v/v	-	1.0	pr. EN 12177
Carbon/hydrogen ratio		Report		
Induction period ^{2/}	minutes	480	-	EN-ISO 7536
Oxygen content	per cent m/m	-	1.0	EN 1601
Existent gum	mg/ml	-	0.04	EN-ISO 6246
Sulphur content ^{3/}	mg/kg	-	10	ASTM D 5453
Copper corrosion		-	class 1	EN-ISO 2160
Lead content	mg/l	-	5	EN 237
Phosphorus content	mg/l	-	1.3	ASTM D 3231

^{1/} The values quoted in the specifications are “true values”. In establishment of their limit values the terms of ISO 4259 “Petroleum products – Determination and application of precision data in relation to methods of test” have been applied and in fixing a minimum value, a minimum difference of 2R above zero has been taken into account; in fixing a maximum and minimum value, the minimum difference is 4R (R = reproducibility).

Notwithstanding this measure, which is necessary for technical reasons, the manufacturer of fuels should nevertheless aim at a zero value where the stipulated maximum value is 2R and at the mean value in the case of quotations of maximum and minimum limits. Should it be necessary to clarify the questions as to whether a fuel meets the requirements of the specifications, the terms of ISO 4259 should be applied.

^{2/} The fuel may contain oxidation inhibitors and metal deactivators normally used to stabilise refinery gasoline streams, but detergent/dispersive additives and solvent oils must not be added.

^{3/} The actual sulphur content of the fuel used for the Type I test shall be reported.

2.2. TECHNICAL DATA ON THE REFERENCE FUEL TO BE USED FOR TESTING VEHICLES EQUIPPED WITH DIESEL ENGINES

Type: Diesel fuel

Parameter	Unit	Limits ^{1/}		Test Method
		minimum	maximum	
Cetane number ^{2/}		52.0	54.0	EN-ISO 5165
Density at 15°C	kg/m ³	833	837	EN-ISO 3675
Distillation:				
50 per cent point	°C	245	-	EN-ISO 3405
95 per cent point	°C	345	350	EN-ISO 3405
- Final boiling point	°C	-	370	EN-ISO 3405
Flash point	°C	55	-	EN 22719
CFPP	°C	-	-5	EN 116
Viscosity at 40 °C	mm ² /s	2.3	3.3	EN-ISO 3104
Polycyclic aromatic hydrocarbons	per cent m/m	3.0	6.0	IP 391
Sulphur content ^{3/}	mg/kg	-	10	ASTM D 5453
Copper corrosion		-	Class 1	EN-ISO 2160
Conradson carbon residue (10 per cent DR)	per cent m/m	-	0.2	EN-ISO 10370
Ash content	per cent m/m	-	0.01	EN-ISO 6245
Water content	per cent m/m	-	0.02	EN-ISO 12937
Neutralisation (strong acid) number	mg KOH/g	-	0.02	ASTM D 974
Oxidation stability ^{4/}	mg/ml	-	0.025	EN-ISO 12205
Lubricity (HFRR wear scan diameter at 60 °C)	µm	-	400	CEC F-06-A-96
FAME	Prohibited			

^{1/} The values quoted in the specifications are “true values”. In establishment of their limit values the terms of ISO 4259 “Petroleum products – Determination and application of precision data in relation to methods of test” have been applied and in fixing a minimum value, a minimum difference of 2R above zero has been taken into account; in fixing a maximum and minimum value, the minimum difference is 4R (R = reproducibility).

Notwithstanding this measure, which is necessary for technical reasons, the manufacturer of fuels should nevertheless aim at a zero value where the stipulated maximum value is 2R and at the mean value in the case of quotations of maximum and minimum limits. Should it be necessary to clarify the questions as to whether a fuel meets the requirements of the specifications, the terms of ISO 4259 should be applied.

^{2/} The range for cetane number is not in accordance with the requirements of a minimum range of 4R. However, in the case of a dispute between fuel supplier and fuel user, the terms of ISO 4259 may be used to resolve such disputes provided replicate measurements, of sufficient number to achieve the necessary precision, are made in preference to single determinations.

^{3/} The actual sulphur content of the fuel used for the Type I test shall be reported.

^{4/} Even though oxidation stability is controlled, it is likely that shelf life will be limited. Advice should be sought from the supplier as to storage conditions and life.

3. SPECIFICATIONS OF REFERENCE FUEL
TO BE USED FOR TESTING VEHICLES EQUIPPED WITH POSITIVE-
IGNITION ENGINES AT LOW AMBIENT TEMPERATURE - TYPE VI
TEST

Type: Unleaded petrol

Parameter	Unit	Limits ^{1/}		Test Method
		minimum	maximum	
Research octane number, RON		95.0	-	EN 25164
Motor octane number, MON		85.0	-	EN 25163
Density at 15 °C	kg/m ³	740	754	ISO 3675
Reid vapour pressure	kPa	56.0	95.0	prEN ISO 13016-1 (DVPE)
Distillation:				
- Evaporated at 70 °C	per cent v/v	24.0	40.0	EN-ISO 3405
- Evaporated at 100 °C	per cent v/v	50.0	58.0	EN-ISO 3405
- Evaporated at 150 °C	per cent v/v	83.0	89.0	EN-ISO 3405
- final boiling point	°C	190	210	EN-ISO 3405
Residue	per cent v/v	-	2.0	EN-ISO 3405
Hydrocarbon analysis:				
Olefins	per cent v/v	-	10.0	ASTM D 1319
Aromatics	per cent v/v	29.0	35.0	ASTM D 1319
Saturates	per cent v/v	Report		ASTM D 1319
Benzene	per cent v/v	-	1.0	pr. EN 12177
Carbon/hydrogen ratio		Report		
Induction period ^{2/}	minutes	480	-	EN-ISO 7536
Oxygen content	per cent m/m	-	1.0	EN 1601
Existent gum	mg/ml	-	0.04	EN-ISO 6246
Sulphur content ^{3/}	mg/kg	-	10	ASTM D 5453
Copper corrosion		-	Class 1	EN-ISO 2160
Lead content	mg/l	-	5	EN 237
Phosphorus content	mg/l	-	1.3	ASTM D 3231

^{1/} The values quoted in the specifications are “true values”. In establishment of their limit values the terms of ISO 4259 “Petroleum products – Determination and application of precision data in relation to methods of test” have been applied and in fixing a minimum value, a minimum difference of 2R above zero has been taken into account; in fixing a maximum and minimum value, the minimum difference is 4R (R = reproducibility).

Notwithstanding this measure, which is necessary for technical reasons, the manufacturer of fuels should nevertheless aim at a zero value where the stipulated maximum value is 2R and at the mean value in the case of quotations of maximum and minimum limits. Should it be necessary to clarify the questions as to whether a fuel meets the requirements of the specifications, the terms of ISO 4259 should be applied.

^{2/} The fuel may contain oxidation inhibitors and metal deactivators normally used to stabilise refinery gasoline streams, but detergent/dispersive additives and solvent oils must not be added.

^{3/} The actual sulphur content of the fuel used for the Type VI test shall be reported.

Annex 10a

1. SPECIFICATIONS OF GASEOUS REFERENCE FUELS

1.1. TECHNICAL DATA OF THE LPG REFERENCE FUELS

1.1.1. TECHNICAL DATA OF THE LPG REFERENCE FUELS USED FOR TESTING VEHICLES TO THE EMISSION LIMITS GIVEN IN ROW A OF THE TABLE IN PARAGRAPH 5.3.1.4. – TYPE I TEST

Parameter	Unit	Fuel A	Fuel B	Test method
<i>Composition:</i>				ISO 7941
C ₃ -content	per cent vol	30 ± 2	85 ± 2	
C ₄ -content	per cent vol	balance	balance	
< C ₃ , >C ₄	per cent vol	max. 2	max. 2	
Olefins	per cent vol	max. 12	max. 15	
Evaporation residue	mg/kg	max. 50	max. 50	ISO 13757
Water at 0°C		free	free	visual inspection
Total sulphur content	mg/kg	max. 50	max. 50	EN 24260
Hydrogen sulphide		none	none	ISO 8819
Copper strip corrosion	rating	Class 1	class 1	ISO 6251 <u>1/</u>
Odour		characteristic	characteristic	
Motor octane number		min. 89	min. 89	EN 589 Annex B

1/ This method may not accurately determine the presence of corrosive materials if the sample contains corrosion inhibitors or other chemicals which diminish the corrosivity of the sample to the copper strip. Therefore, the addition of such compounds for the sole purpose of biasing the test method is prohibited.

1.1.2. TECHNICAL DATA OF THE LPG REFERENCE FUELS USED FOR TESTING VEHICLES TO THE EMISSION LIMITS GIVEN IN ROW B OF THE TABLE IN PARAGRAPH 5.3.1.4. OF ANNEX I - TYPE I TEST

Parameter	Unit	Fuel A	Fuel B	Test method
<i>Composition:</i>				ISO 7941
C ₃ -content	per cent vol	30 ± 2	85 ± 2	
C ₄ -content	per cent vol	balance	balance	
< C ₃ , >C ₄	per cent vol	max. 2	max. 2	
Olefins	per cent vol	max. 12	max. 15	
Evaporation residue	mg/kg	max. 50	max. 50	ISO 13757
Water at 0 °C		free	free	Visual inspection
Total sulphur content	mg/kg	max. 10	max. 10	EN 24260
Hydrogen sulphide		none	none	ISO 8819
Copper strip corrosion	Rating	class 1	class 1	ISO 6251 1/
Odour		characteristic	characteristic	
Motor octane number		min. 89	min. 89	EN 589 Annex B

1/ This method may not accurately determine the presence of corrosive materials if the sample contains corrosion inhibitors or other chemicals which diminish the corrosivity of the sample to the copper strip. Therefore, the addition of such compounds for the sole purpose of biasing the test method is prohibited.

1.2. TECHNICAL DATA OF THE NG REFERENCE FUELS

Characteristics	Units	Basis	Limits		Test Method
			minimum	maximum	
Reference fuel G₂₀					
<i>Composition:</i>					
Methane	per cent mole	100	99	100	ISO 6974
Balance <u>1/</u>	per cent mole	-	-	1	ISO 6974
N ₂	per cent mole				ISO 6974
Sulphur content	mg/m ³ <u>2/</u>	-	-	10	ISO 6326-5
Wobbe Index (net)	MJ/m ³ <u>3/</u>	48.2	47.2	49.2	
Reference fuel G₂₅					
<i>Composition:</i>					
Methane	per cent mole	86	84	88	ISO 6974
Balance <u>1/</u>	per cent mole	-	-	1	ISO 6974
N ₂	per cent mole	14	12	16	ISO 6974
Sulphur content	mg/m ³ <u>2/</u>	-	-	10	ISO 6326-5
Wobbe Index (net)	MJ/m ³ <u>3/</u>	39.4	38.2	40.6	

1/ Inerts (different from N₂) + C₂ + C₂₊

2/ Value to be determined at 293.2 K (20 °C) and 101.3 kPa

3/ Value to be determined at 273.2 K (0 °C) and 101.3 kPa"

Annex 11

ON-BOARD DIAGNOSTICS (OBD) FOR MOTOR VEHICLES

1. INTRODUCTION

This Annex applies to the functional aspects of on-board diagnostic (OBD) system for the emission control of motor vehicles.

2. DEFINITIONS

For the purposes of this Annex:

- 2.1. “OBD” means an on-board diagnostic system for emission control which shall have the capability of identifying the likely area of malfunction by means of fault codes stored in computer memory.
- 2.2. “Vehicle type” means a category of power-driven vehicles which do not differ in such essential engine and OBD system characteristics.
- 2.3. “Vehicle family” means a manufacturer's grouping of vehicles which, through their design, are expected to have similar exhaust emission and OBD system characteristics. Each vehicle of this family shall have complied with the requirements of this Regulation as defined in Appendix 2 to this Annex.
- 2.4. “Emission control system” means the electronic engine management controller and any emission-related component in the exhaust or evaporative system which supplies an input to or receives an output from this controller.
- 2.5. “Malfunction indicator (MI)” means a visible or audible indicator that clearly informs the driver of the vehicle in the event of a malfunction of any emission-related component connected to the OBD system, or the OBD system itself.
- 2.6. “Malfunction” means the failure of an emission-related component or system that would result in emissions exceeding the limits in paragraph 3.3.2. or if the OBD system is unable to fulfill the basic monitoring requirements of this Annex.
- 2.7. “Secondary air” refers to air introduced into the exhaust system by means of a pump or aspirator valve or other means that is intended to aid in the oxidation of HC and CO contained in the exhaust gas stream.

- 2.8. “Engine misfire” means lack of combustion in the cylinder of a positive-ignition engine due to absence of spark, poor fuel metering, poor compression or any other cause. In terms of OBD monitoring it is that percentage of misfires out of a total number of firing events (as declared by the manufacturer) that would result in emissions exceeding the limits given in paragraph 3.3.2. or that percentage that could lead to an exhaust catalyst, or catalysts, overheating causing irreversible damage.
- 2.9. “Type I test” means the driving cycle (Parts One and Two) used for emission approvals, as detailed in Annex 4, Appendix 1.
- 2.10. A “driving cycle” consists of engine start-up, driving mode where a malfunction would be detected if present, and engine shut-off.
- 2.11. A “warm-up cycle” means sufficient vehicle operation such that the coolant temperature has risen by a least 22 K from engine starting and reaches a minimum temperature of 343 K (70 °C).
- 2.12. “Fuel trim” refers to feedback adjustments to the base fuel schedule. Short-term fuel trim refers to dynamic or instantaneous adjustments. Long-term fuel trim refers to much more gradual adjustments to the fuel calibration schedule than short-term trim adjustments. These long-term adjustments compensate for vehicle differences and gradual changes that occur over time.
- 2.13. “Calculated load value” refers to an indication of the current airflow divided by peak airflow, where peak airflow is corrected for altitude, if available. This definition provides a dimensionless number that is not engine specific and provides the service technician with an indication of the proportion of engine capacity that is being used (with wide open throttle as 100 per cent);
- $$CLV = \frac{\text{Current airflow}}{\text{Peak airflow (at sea level)}} \cdot \frac{\text{Atmospheric pressure (at sea level)}}{\text{Barometric pressure}}$$
- 2.14. “Permanent emission default mode” refers to a case where the engine management controller permanently switches to a setting that does not require an input from a failed component or system where such a failed component or system would result in an increase in emissions from the vehicle to a level above the limits given in paragraph 3.3.2. of this Annex.
- 2.15. “Power take-off unit” means an engine-driven output provision for the purposes of powering auxiliary, vehicle mounted, equipment.

- 2.16. “Access” means the availability of all emission-related OBD data including all fault codes required for the inspection, diagnosis, servicing or repair of emissions-related parts of the vehicle, via the serial interface for the standard diagnostic connection (pursuant to Appendix 1 to this Annex, paragraph 6.5.3.5.).
- 2.17. “Unrestricted” means:
- 2.17.1 access not dependent on an access code obtainable only from the manufacturer, or a similar device, or
- 2.17.2 access allowing evaluation of the data produced without the need for any unique decoding information, unless that information itself is standardised.
- 2.18. “Standardised” means that all data stream information, including all fault codes used, shall be produced only in accordance with industry standards which, by virtue of the fact that their format and their permitted options are clearly defined, provide for a maximum level of harmonisation in the motor vehicle industry, and whose use is expressly permitted in this Regulation.
- 2.19. “Repair information” means all information required for diagnosis, servicing, inspection, periodic monitoring or repair of the vehicle and which the manufacturers provide for their authorised dealers/repair shops. Where necessary, such information shall include service handbooks, technical manuals, diagnosis information (e.g. minimum and maximum theoretical values for measurements), wiring diagrams, the software calibration identification number applicable to a vehicle type, instructions for individual and special cases, information provided concerning tools and equipment, data record information and two-directional monitoring and test data. The manufacturer shall not be obliged to make available that information which is covered by intellectual property rights or constitutes specific know-how of manufacturers and/or OEM suppliers; in this case the necessary technical information shall not be improperly withheld.
- 2.20. “Deficiency” means, in respect of vehicle OBD systems, that up to two separate components or systems that are monitored contain temporary or permanent operating characteristics that impair the otherwise efficient OBD monitoring of those components or systems or do not meet all of the other detailed requirements for OBD. Vehicles may be type-approved, registered and sold with such deficiencies according to the requirements of paragraph 4 of this Annex.

3. REQUIREMENTS AND TESTS

3.1. All vehicles shall be equipped with an OBD system so designed, constructed and installed in a vehicle as to enable it to identify types of deterioration or malfunction over the entire life of the vehicle. In achieving this objective the approval authority shall accept that vehicles which have travelled distances in excess of the Type V durability distance, referred to in paragraph 3.3.1., may show some deterioration in OBD system performance such that the emission limits given in paragraph 3.3.2. may be exceeded before the OBD system signals a failure to the driver of the vehicle.

3.1.1. Access to the OBD system required for the inspection, diagnosis, servicing or repair of the vehicle shall be unrestricted and standardised. All emission-related fault codes shall be consistent with paragraph 6.5.3.4. of Appendix 1 to this annex.

3.1.2. No later than three months after the manufacturer has provided any authorised dealer or repair shop with repair information, the manufacturer shall make that information (including all subsequent amendments and supplements) available upon reasonable and non-discriminatory payment and shall notify the approval authority accordingly.

In the event of failure to comply with these provisions the approval authority shall act to ensure that repair information is available, in accordance with the procedures laid down for type approval and in-service surveys.

3.2. The OBD system shall be so designed, constructed and installed in a vehicle as to enable it to comply with the requirements of this annex during conditions of normal use.

3.2.1. Temporary disablement of the OBD system

3.2.1.1. A manufacturer may disable the OBD system if its ability to monitor is affected by low fuel levels. Disablement shall not occur when the fuel tank level is above 20 per cent of the nominal capacity of the fuel tank.

3.2.1.2. A manufacturer may disable the OBD system at ambient engine starting temperatures below 266 K (-7°C) or at elevations over 2,500 metres above sea level provided the manufacturer submits data and/or an engineering evaluation which adequately demonstrate that monitoring would be unreliable when such conditions exist. A manufacturer may also request disablement of the OBD system at other ambient engine starting temperatures if he demonstrates to the authority with data and/or an engineering evaluation that misdiagnosis would occur under

such conditions. It is not necessary to illuminate the malfunction indicator (MI) if the OBD thresholds are exceeded during a regeneration provided no defect is present.

- 3.2.1.3. For vehicles designed to accommodate the installation of power take-off units, disablement of affected monitoring systems is permitted provided disablement occurs only when the power take-off unit is active.
- 3.2.2. Engine misfire in vehicles equipped with positive-ignition engines
 - 3.2.2.1. Manufacturers may adopt higher misfire percentage malfunction criteria than those declared to the authority, under specific engine speed and load conditions where it can be demonstrated to the authority that the detection of lower levels of misfire would be unreliable.
 - 3.2.2.2. When a manufacturer can demonstrate to the authority that the detection of higher levels of misfire percentages is still not feasible, or that misfire cannot be distinguished from other effects (e.g. rough roads, transmission shifts, after engine starting; etc.) the misfire monitoring system may be disabled when such conditions exist.
- 3.3. Description of tests
 - 3.3.1. The test are carried out on the vehicle used for the Type V durability test, given in Annex 9, and using the test procedure in Appendix 1 to this annex. Tests are carried out at the conclusion of the Type V durability testing.

When no Type V durability testing is carried out, or at the request of the manufacturer, a suitably aged and representative vehicle may be used for these OBD demonstration tests.
 - 3.3.2. The OBD system shall indicate the failure of an emission-related component or system when that failure results in emissions exceeding the threshold limits given below:

Category	Class	Reference mass (RM) (kg)	Mass of carbon monoxide (CO) L ₁ (g/km)		Mass of total hydrocarbons (THC) L ₂ (g/km)		Mass of oxides of nitrogen (NO _x) L ₃ (g/km)		Mass of particulates (1) (PM) L ₄ (g/km)
			Petrol	Diesel	Petrol	Diesel	Petrol	Diesel	Diesel
M(2)	-	all	3.20	3.20	0.40	0.40	0.60	1.20	0.18
N ₁ (3)	I	RM ≤ 1305	3.20	3.20	0.40	0.40	0.60	1.20	0.18
	II	1305 < RM ≤ 1760	5.80	4.00	0.50	0.50	0.70	1.60	0.23
	III	1760 < RM	7.30	4.80	0.60	0.60	0.80	1.90	0.28

(1) For compression-ignition engines.

(2) Except vehicles the maximum mass of which exceeds 2,500 kg.

(3) And those category M vehicles which are specified in note (2).

3.3.3. Monitoring requirements for vehicles equipped with positive-ignition engines.

In satisfying the requirements of paragraph 3.3.2. the OBD system shall, at a minimum, monitor for:

3.3.3.1. reduction in the efficiency of the catalytic converter with respect to the emissions of HC only. Manufacturers may monitor the front catalyst alone or in combination with the next catalyst(s) downstream. Each monitored catalyst or catalyst combination shall be considered malfunctioning when the emissions exceed the HC threshold given in table in paragraph 3.3.2.;

3.3.3.2. the presence of engine misfire in the engine operating region bounded by the following lines:

- (a) a maximum speed of 4,500 min⁻¹ or 1,000 min⁻¹ greater than the highest speed occurring during a Type I test cycle, whichever is the lower;
- (b) the positive torque line (i.e. engine load with the transmission in neutral);
- (c) a line joining the following engine operating points: the positive torque line at 3,000 min⁻¹ and a point on the maximum speed line defined in (a) above with the engine's manifold vacuum at 13.33 kPa lower than that at the positive torque line.

- 3.3.3.3. oxygen sensor deterioration;
- 3.3.3.4. if active on the selected fuel, other emission control system components or systems, or emission related powertrain components or systems which are connected to a computer, the failure of which may result in tailpipe emissions exceeding the limits given in paragraph 3.3.2;
- 3.3.3.5. unless otherwise monitored, any other emission-related power-train component connected to a computer, including any relevant sensors to enable monitoring functions to be carried out, shall be monitored for circuit continuity;
- 3.3.3.6. the electronic evaporative emission purge control shall, at a minimum, be monitored for circuit continuity.
- 3.3.4. Monitoring requirements for vehicles equipped with compression-ignition engines

In satisfying the requirements of paragraph 3.3.2. the OBD system shall monitor:
 - 3.3.4.1. where fitted, reduction in the efficiency of the catalytic converter;
 - 3.3.4.2. where fitted, the functionality and integrity of the particulate trap;
 - 3.3.4.3. the fuel-injection system electronic fuel quantity and timing actuator(s) is/are monitored for circuit continuity and total functional failure;
 - 3.3.4.4. other emission control system components or systems, or emission-related power-train components or systems, which are connected to a computer, the failure of which may result in exhaust emissions exceeding the limits given in paragraph 3.3.2. Examples of such systems or components are those for monitoring and control of air mass-flow, air volumetric flow (and temperature), boost pressure and inlet manifold pressure (and relevant sensors to enable these functions to be carried out).
 - 3.3.4.5. Unless otherwise monitored, any other emission-related power-train component connected to a computer shall be monitored for circuit continuity.
- 3.3.5. Manufacturers may demonstrate to the approval authority that certain components or systems need not be monitored if, in the event of their total failure or removal, emissions do not exceed the emission limits given in paragraph 3.3.2.
- 3.4. A sequence of diagnostic checks shall be initiated at each engine start and completed at least once provided that the correct test conditions are met. The test conditions shall be selected in such a way that they all occur under normal driving as represented by the Type I test.

3.5. Activation of malfunction indicator (MI)

3.5.1. The OBD system shall incorporate a malfunction indicator readily perceivable to the vehicle operator. The MI shall not be used for any other purpose except to indicate emergency start-up or limp-home routines to the driver. The MI shall be visible in all reasonable lighting conditions. When activated, it shall display a symbol in conformity with ISO 2575 ^{1/}. A vehicle shall not be equipped with more than one general purpose MI for emission-related problems. Separate specific purpose telltales (e. g. brake system, fasten seat belt, oil pressure, etc.) are permitted. The use of red colour for an MI is prohibited.

3.5.2. For strategies requiring more than two preconditioning cycles for MI activation, the manufacturer must provide data and/or an engineering evaluation which adequately demonstrates that the monitoring system is equally effective and timely in detecting component deterioration. Strategies requiring on average more than ten driving cycles for MI activation are not accepted. The MI must also activate whenever the engine control enters a permanent emission default mode of operation if the emission limits given in paragraph 3.3.2. are exceeded or if the OBD system is unable to fulfil the basic monitoring requirements specified in paragraph 3.3.3. or 3.3.4. of this Annex. The MI must operate in a distinct warning mode, e.g. a flashing light, under any period during which engine misfire occurs at a level likely to cause catalyst damage, as specified by the manufacturer. The MI must also activate when the vehicle's ignition is in the "key-on" position before engine starting or cranking and de-activate after engine starting if no malfunction has previously been detected.

3.6. Fault code storage

The OBD system must record fault code(s) indicating the status of the emission control system. Separate status codes must be used to identify correctly functioning emission control systems and those emission control systems which need further vehicle operation to be fully evaluated. If the MI is activated due to deterioration or malfunction or permanent emission default modes of operation, a fault code must be stored that identifies the type of malfunction. A fault code must also be stored in the cases referred to in paragraphs 3.3.3.5. and 3.3.4.5. of this Annex.

^{1/} International Standard ISO 2575-1982 (E), entitled "Road vehicles: Symbols for control indicators and tell-tales", Symbol Number 4.36.

- 3.6.1. The distance travelled by the vehicle while the MI is activated shall be available at any instant through the serial port on the standard link connector. ^{2/}
- 3.6.2. In the case of vehicles equipped with positive-ignition engines, misfiring cylinders need not be uniquely identified if a distinct single or multiple cylinder misfire fault code is stored.
- 3.7. Extinguishing the MI
- 3.7.1. If misfire at levels likely to cause catalyst damage (as specified by the manufacturer) is not present any more, or if the engine is operated after changes to speed and load conditions where the level of misfire will not cause catalyst damage, the MI may be switched back to the previous state of activation during the first driving cycle on which the misfire level was detected and may be switched to the normal activated mode on subsequent driving cycles. If the MI is switched back to the previous state of activation, the corresponding fault codes and stored freeze-frame conditions may be erased.
- 3.7.2. For all other malfunctions, the MI may be de-activated after three subsequent sequential driving cycles during which the monitoring system responsible for activating the MI ceases to detect the malfunction and if no other malfunction has been identified that would independently activate the MI.
- 3.8. Erasing a fault code
- 3.8.1. The OBD system may erase a fault code and the distance travelled and freeze-frame information if the same fault is not re-registered in at least 40 engine warm-up cycles.
- 3.9. Bi-fuelled gas vehicles
- 3.9.1. For bi-fuelled gas vehicles, the procedures:
- activation of malfunction indicator (MI) (see paragraph 3.5. of this Annex);
 - fault code storage (see paragraph 3.6. of this Annex);
 - extinguishing the MI (see paragraph 3.7. of this Annex);
 - erasing a fault code (see paragraph 3.8. of this Annex),
- shall be executed independently of each other when the vehicle is operated on petrol or on gas. When the vehicle is operated on petrol, the result of any of the procedures indicated above shall not be affected when the vehicle is operated on gas. When the vehicle is operated on gas, the result of any of the

^{2/} This requirement is only applicable from 1 January 2003 to new types of vehicles with an electronic speed input to the engine management. It applies to all vehicles entering into service from 1 January 2005.

procedures indicated above shall not be affected when the vehicle is operated on petrol.

Notwithstanding this requirement, the status code (described in paragraph 3.6. of this Annex) shall indicate fully evaluated control systems for both fuel types (petrol and gas) when the control systems are fully evaluated for one of the fuel types.

4. REQUIREMENTS RELATING TO THE TYPE-APPROVAL OF ON-BOARD DIAGNOSTIC SYSTEMS

4.1. A manufacturer may request to the authority that an OBD system be accepted for type-approval even though the system contains one or more deficiencies such that the specific requirements of this Annex are not fully met.

4.2. In considering the request, the authority shall determine whether compliance with the requirements of this Annex is infeasible or unreasonable.

The authority shall take into consideration data from the manufacturer that details such factors as, but not limited to, technical feasibility, lead time and production cycles including phase-in or phase-out of engines or vehicle designs and programmed upgrades of computers, the extent to which the resultant OBD system will be effective in complying with the requirements of this Regulation and that the manufacturer has demonstrated an acceptable level of effort towards compliance with the requirements of this Regulation.

4.2.1. The authority will not accept any deficiency request that includes the complete lack of a required diagnostic monitor.

4.2.2. The authority will not accept any deficiency request that does not respect the OBD threshold limits in paragraph 3.3.2.

4.3. In determining the identified order of deficiencies, deficiencies relating to paragraphs 3.3.3.1, 3.3.3.2 and 3.3.3.3. of this Annex for positive-ignition engines and paragraphs 3.3.4.1, 3.3.4.2. and 3.3.4.3. of this Annex for compression-ignition engines shall be identified first.

4.4. Prior to or at the time of type-approval, no deficiency shall be granted in respect of the requirements of paragraph 6.5., except paragraph 6.5.3.4. of Appendix 1 to this Annex. This paragraph does not apply to bi-fuelled gas vehicles.

4.5. Bi-fuelled gas vehicles

4.5.1. Notwithstanding the requirements of paragraph 3.9.1., and where requested by the manufacturer, the administrative department shall accept the following deficiencies as meeting the requirements of this Annex for the purpose of the type-approval of bi-fuelled gas vehicles:

- erasing of fault codes, distance travelled and freeze-frame information after 40 engine warm-up cycles, independent of the fuel currently in use;
- activation of the MI on both fuel types (petrol and gas) after the detection of a malfunction on one of the fuel types;
- de-activation of the MI after three subsequent sequential driving cycles without malfunction, independent of the fuel currently in use;
- use of two status codes, one for each fuel type.

Further options may be requested by the manufacturer and granted at the discretion of the administrative department.

4.5.2. Notwithstanding the requirements of paragraph 6.6. of Appendix 1 to this Annex, and where requested by the manufacturer, the type-approval shall accept the following deficiencies as meeting the requirements of this Annex for the evaluation and transmission of diagnostic signals:

- transmission of the diagnostic signals for the fuel currently in use on a single source address;
- evaluation of one set of diagnostic signals for both fuel types (corresponding to the evaluation on mono-fuelled gas vehicles, and independent of the fuel currently in use);
- selection of one set of diagnostic signals (associated to one of the two fuel types) by the position of a fuel switch;
- evaluation and transmission of one set of diagnostic signals for both fuels in the petrol computer independent of the fuel use. The gas supply system computer will evaluate and transmit the gaseous fuel system related diagnostic signals and store status history.

Further options may be requested by the manufacturer and granted at the discretion of the type-approval authority.

4.6. Deficiency period

4.6.1. A deficiency may be carried-over for a period of two years after the date of type-approval of the vehicle type unless it can be adequately demonstrated that substantial vehicle hardware modifications and additional lead-time beyond two years would be necessary to correct the deficiency. In such a case, the deficiency may be carried-over for a period not exceeding three years.

- 4.6.1.1. In the case of a bi-fuelled gas vehicle, a deficiency granted in accordance with paragraph 4.5. may be carried-over for a period of three years after the date of type-approval of the vehicle type unless it can be adequately demonstrated that substantial vehicle hardware modifications and additional lead-time beyond three years would be necessary to correct the deficiency. In such a case, the deficiency may be carried-over for a period not exceeding four years.
- 4.6.2. A manufacturer may request that the administrative department grant a deficiency retrospectively when such a deficiency is discovered after the original type-approval. In this case, the deficiency may be carried-over for a period of two years after the date of notification to the administrative department unless it can be adequately demonstrated that substantial vehicle hardware modifications and additional lead-time beyond two years would be necessary to correct the deficiency. In such a case, the deficiency may be carried-over for a period not exceeding three years.
- 4.7. The authority shall notify its decision in granting a deficiency request to all other Parties to the 1958 Agreement applying this Regulation.

5. ACCESS TO OBD INFORMATION

- 5.1. Applications for type-approval or amendment of a type-approval shall be accompanied by the relevant information concerning the vehicle OBD system. This relevant information shall enable manufacturers of replacement or retrofit components to make the parts they manufacture compatible with the vehicle OBD system with a view to fault-free operation assuring the vehicle user against malfunctions. Similarly, such relevant information shall enable the manufacturers of diagnostic tools and test equipment to make tools and equipment that provide for effective and accurate diagnosis of vehicle emission control systems.
- 5.2. Upon request, the administrative departments shall make Appendix 1 of Annex 2 containing the relevant information on the OBD system available to any interested components, diagnostic tools or test equipment manufacturer on a non-discriminatory basis.
- 5.2.1. If a administrative department receives a request from any interested components, diagnostic tools or test equipment manufacturer for information on the OBD system of a vehicle that has been type-approved to a previous version of this Regulation,
- the administrative department shall, within 30 days, request the manufacturer of the type vehicle in question to make available the information required in

paragraph 4.2.11.2.7.6. of Annex 1. The requirement of the second section of paragraph 4.2.11.2.7.6. is not applicable;

- the manufacturer shall submit this information to the administrative department within two months of the request;
- the administrative department shall transmit this information to the administrative departments of the Contracting Parties and the administrative department which granted the original type-approval shall attach this information to Annex 1 of the vehicle type-approval information;

This requirement shall not invalidate any approval previously granted pursuant to Regulation No. 83 nor prevent extensions to such approvals under the terms of the Regulation under which they were originally granted.

- 5.2.2. Information can only be requested for replacement or service components that are subject to UNECE type-approval, or for components that form part of a system that is subject to UNECE type-approval.
- 5.2.3. The request for information must identify the exact specification of the vehicle model for which the information is required. It must confirm that the information is required for the development of replacement or retrofit parts or components or diagnostic tools or test equipment.
-

Annex 11 - Appendix 1

FUNCTIONAL ASPECTS OF ON-BOARD DIAGNOSTIC (OBD) SYSTEMS

1. INTRODUCTION

This Appendix describes the procedure of the test according to paragraph 3. of Annex 11. The procedure describes a method for checking the function of the on-board diagnostic (OBD) system installed on the vehicle by failure simulation of relevant systems in the engine management or emission control system. It also sets procedures for determining the durability of OBD systems.

The manufacturer shall make available the defective components and/or electrical devices which would be used to simulate failures. When measured over the Type I test cycle, such defective components or devices shall not cause the vehicle emissions to exceed the limits of paragraph 3.3.2. by more than 20 per cent.

When the vehicle is tested with the defective component or device fitted, the OBD system is approved if the MI is activated. The OBD system is also approved if the MI is activated below the OBD threshold limits.

2. DESCRIPTION OF TEST

2.1. The testing of OBD systems consists of the following phases:

- 2.1.1. simulation of malfunction of a component of the engine management or emission control system,
 - 2.1.2. preconditioning of the vehicle with a simulated malfunction over preconditioning specified in paragraph 6.2.1. or paragraph 6.2.2.
 - 2.1.3. driving the vehicle with a simulated malfunction over the Type I test cycle and measuring the emissions of the vehicle,
 - 2.1.4. determining whether the OBD system reacts to the simulated malfunction and indicates malfunction in an appropriate manner to the vehicle driver.
- 2.2. Alternatively, at the request of the manufacturer, malfunction of one or more components may be electronically simulated according to the requirements of paragraph 6. below.

- 2.3. Manufacturers may request that monitoring take place outside the Type I test cycle if it can be demonstrated to the authority that monitoring during conditions encountered during the Type I test cycle would impose restrictive monitoring conditions when the vehicle is used in service.

3. TEST VEHICLE AND FUEL

3.1. Vehicle

The test vehicle shall meet the requirements of paragraph 3.1. of Annex 4.

3.2. Fuel

The appropriate reference fuel as described in Annex 10 for petrol and diesel fuels and in Annex 10a for LPG and NG fuels must be used for testing. The fuel type for each failure mode to be tested (described in paragraph 6.3. of this Appendix) may be selected by the administrative department from the reference fuels described in Annex 10a in the case of the testing of a mono-fuelled gas vehicle and from the reference fuels described in Annex 10 or Annex 10a in the case of the testing of a bi-fuelled gas vehicle. The selected fuel type must not be changed during any of the test phases (described in paragraphs 2.1. to 2.3. of this Appendix). In the case of the use of LPG or NG as a fuel it is permissible that the engine is started on petrol and switched to LPG or NG after a pre-determined period of time which is controlled automatically and not under the control of the driver.

4. TEST TEMPERATURE AND PRESSURE

- 4.1. The test temperature and pressure shall meet the requirements of the Type I test as described in Annex 4.

5. TEST EQUIPMENT

5.1. Chassis dynamometer

The chassis dynamometer shall meet the requirements of Annex 4.

6. OBD TEST PROCEDURE

- 6.1. The operating cycle on the chassis dynamometer shall meet the requirements of Annex 4.

- 6.2. Vehicle preconditioning
 - 6.2.1. According to the engine type and after introduction of one of the failure modes given in paragraph 6.3., the vehicle shall be preconditioned by driving at least two consecutive Type I tests (Parts One and Two). For compression-ignition engines vehicles an additional preconditioning of two Part Two cycles is permitted.
 - 6.2.2. At the request of the manufacturer, alternative preconditioning methods may be used.
- 6.3. Failure modes to be tested
 - 6.3.1. Positive-ignition engines vehicles:
 - 6.3.1.1. replacement of the catalyst with a deteriorated or defective catalyst or electronic simulation of such a failure;
 - 6.3.1.2. engine misfire conditions according to the conditions for misfire monitoring given in paragraph 3.3.3.2. of Annex 11;
 - 6.3.1.3. replacement of the oxygen sensor with a deteriorated or defective oxygen sensor or electronic simulation of such a failure;
 - 6.3.1.4. electrical disconnection of any other emission-related component connected to a power-train management computer (if active on the selected fuel type);
 - 6.3.1.5. electrical disconnection of the evaporative purge control device (if equipped and if active on the selected fuel type). For this specific failure mode, the Type I test need not be performed.
 - 6.3.2. Compression-ignition engines vehicles:
 - 6.3.2.1. where fitted, replacement of the catalyst with a deteriorated or defective catalyst or electronic simulation of such a failure;
 - 6.3.2.2. where fitted, total removal of the particulate trap or, where sensors are an integral part of the trap, a defective trap assembly;
 - 6.3.2.3. electrical disconnection of any fuelling system electronic fuel quantity and timing actuator;
 - 6.3.2.4. electrical disconnection of any other emission-related component connected to a power-train management computer;

- 6.3.2.5. in meeting the requirements of paragraphs 6.3.2.3. and 6.3.2.4., and with the agreement of the approval authority, the manufacturer shall take appropriate steps to demonstrate that the OBD system will indicate a fault when disconnection occurs.
- 6.4. OBD system test
- 6.4.1. Vehicles fitted with positive-ignition engines:
- 6.4.1.1. after vehicle preconditioning according to paragraph 6.2., the test vehicle is driven over a Type I test (Parts One and Two);
- the MI shall activate before the end of this test under any of the conditions given in paragraphs 6.4.1.2. to 6.4.1.5. The technical service may substitute those conditions by others in accordance with paragraph 6.4.1.6. However, the total number of failures simulated shall not exceed four (4) for the purpose of type approval;
- 6.4.1.2. replacement of a catalyst with a deteriorated or defective catalyst or electronic simulation of a deteriorated or defective catalyst that results in emissions exceeding the HC limit given in paragraph 3.3.2. of Annex 11;
- 6.4.1.3. an induced misfire condition according to the conditions for misfire monitoring given in paragraph 3.3.3.2. of Annex 11 that results in emissions exceeding any of the limits given in paragraph 3.3.2. of Annex 11;
- 6.4.1.4. replacement of an oxygen sensor with a deteriorated or defective oxygen sensor or electronic simulation of a deteriorated or defective oxygen sensor that results in emissions exceeding any of the limits given in paragraph 3.3.2. of Annex 11;
- 6.4.1.5. electrical disconnection of the electronic evaporative purge control device (if equipped and if active on the selected fuel type);
- 6.4.1.6. electrical disconnection of any other emission-related power-train component connected to a computer that results in emissions exceeding any of the limits given in paragraph 3.3.2. of this Annex (if active on the selected fuel type).
- 6.4.2. Vehicles fitted with compression-ignition engines:
- 6.4.2.1. after vehicle preconditioning according to paragraph 6.2., the test vehicle is driven over a Type I test (Parts One and Two);

the MI shall activate before the end of this test under any of the conditions given in paragraphs 6.4.2.2. to 6.4.2.5. The technical service may substitute those conditions by others in accordance with paragraph 6.4.2.5. However, the total number of failures simulated shall not exceed four for the purposes of type approval;

- 6.4.2.2. where fitted, replacement of a catalyst with a deteriorated or defective catalyst or electronic simulation of a deteriorated or defective catalyst that results in emissions exceeding limits given in paragraph 3.3.2. of Annex 11;
- 6.4.2.3. where fitted, total removal of the particulate trap or replacement of the particulate trap with a defective particulate trap meeting the conditions of paragraph 6.3.2.2. above that results in emissions exceeding the limits given in paragraph 3.3.2. of Annex 11;
- 6.4.2.4. with reference to paragraph 6.3.2.5., disconnection of any fuelling system electronic fuel quantity and timing actuator that results in emissions exceeding any of the limits given in paragraph 3.3.2. of Annex 11;
- 6.4.2.5. with reference to paragraph 6.3.2.5., disconnection of any other emission-related power-train component connected to a computer that results in emissions exceeding any of the limits given in paragraph 3.3.2. of Annex 11.
- 6.5. Diagnostic signals
 - 6.5.1.1. Upon determination of the first malfunction of any component or system, 'freeze-frame' engine conditions present at the time shall be stored in computer memory. Should a subsequent fuel system or misfire malfunction occur, any previously stored freeze-frame conditions shall be replaced by the fuel system or misfire conditions (whichever occurs first). Stored engine conditions shall include, but are not limited to calculated load value, engine speed, fuel trim value(s) (if available), fuel pressure (if available), vehicle speed (if available), coolant temperature, intake manifold pressure (if available), closed- or open-loop operation (if available) and the fault code which caused the data to be stored. The manufacturer shall choose the most appropriate set of conditions facilitating effective repairs for freeze-frame storage. Only one frame of data is required. Manufacturers may choose to store additional frames provided that at least the required frame can be read by a generic scan tool meeting the specifications of paragraphs 6.5.3.2. and 6.5.3.3. If the fault code causing the conditions to be stored is erased in accordance with paragraph 3.7. of Annex 11, the stored engine conditions may also be erased.
 - 6.5.1.2. If available, the following signals in addition to the required freeze-frame information shall be made available on demand through the serial port on the standardised data link connector, if the information is available to the on-board computer or can be determined using information available to the on-board

computer: diagnostic trouble codes, engine coolant temperature, fuel control system status (closed-loop, open-loop, other), fuel trim, ignition timing advance, intake air temperature, manifold air pressure, air flow rate, engine speed, throttle position sensor output value, secondary air status (upstream, downstream or atmosphere), calculated load value, vehicle speed and fuel pressure.

The signals shall be provided in standard units based on the specifications given in paragraph 6.5.3. Actual signals shall be clearly identified separately from default value or limp-home signals.

- 6.5.1.3. For all emission control systems for which specific on-board evaluation tests are conducted (catalyst, oxygen sensor, etc.), except misfire detection, fuel system monitoring and comprehensive component monitoring, the results of the most recent test performed by the vehicle and the limits to which the system is compared shall be made available through the serial data port on the standardised data link connector according to the specifications given in paragraph 6.5.3. For the monitored components and systems excepted above, a pass/fail indication for the most recent test results shall be available through the data link connector.
- 6.5.1.4. The OBD requirements to which the vehicle is certified (i.e. Annex 11 or the alternative requirements specified in paragraph 5.) and the major emission control systems monitored by the OBD system consistent with paragraph 6.5.3.3. shall be available through the serial data port on the standardised data link connector according to the specifications given in paragraph 6.5.3. of this Appendix.
- 6.5.1.5. From 1 January 2003 for new types and from 1 January 2005 for all types of vehicles entering into service, the software calibration identification number shall be made available through the serial port on the standardised data link connector. The software calibration identification number shall be provided in a standardised format.
- 6.5.2. The emission control diagnostic system is not required to evaluate components during malfunction if such evaluation would result in a risk to safety or component failure.
- 6.5.3. The emission control diagnostic system must provide for standardised and unrestricted access and conform with the following ISO standards and/or SAE specification.
- 6.5.3.1. One of the following standards with the restrictions as described must be used as the on-board to off-board communications link:

ISO 9141 - 2: 1994 (amended 1996) "Road Vehicles – Diagnostic Systems – Part 2: CARB requirements for interchange of digital information";

SAE J1850: March 1998 Class B Data Communication Network Interface". Emission-related messages must use the cyclic redundancy check and the three-byte header and not use inter-byte separation or checksums;

ISO 14230 – Part 4 "Road Vehicles – Keyword protocol 2000 for diagnostic systems – Part 4: Requirements for emission-related systems";

ISO DIS 15765-4 "Road vehicles – Diagnostics on Controller Area Network (CAN) – Part 4: Requirements for emissions-related systems", dated 1 November 2001.

6.5.3.2. Test equipment and diagnostic tools needed to communicate with OBD systems must meet or exceed the functional specification given in ISO DIS 15031-4 "Road vehicles – Communication between vehicle and external test equipment for emissions-related diagnostics – Part 4: External test equipment", dated 1 November 2001.

6.5.3.3. Basic diagnostic data, (as specified in paragraph 6.5.1.) and bi-directional control information must be provided using the format and units described in ISO DIS 15031-5 "Road vehicles – Communication between vehicle and external test equipment for emissions-related diagnostics – Part 5: Emissions-related diagnostic services", dated 1 November 2001, and must be available using a diagnostic tool meeting the requirements of ISO DIS 15031-4.

The vehicle manufacturer shall provide to a national standardisation body the details of any emission-related diagnostic data, e.g. PID's, OBD monitor Id's, Test Id's not specified in ISO DIS 15031-5 but related to this Regulation.

6.5.3.4. When a fault is registered, the manufacturer must identify the fault using an appropriate fault code consistent with those given in Section 6.3. of ISO DIS 15031-6 "Road vehicles – Communication between vehicle and external test equipment for emissions-related diagnostics – Part 6: Diagnostic trouble code definitions", relating to "emission related system diagnostic trouble codes". If such identification is not possible, the manufacturer may use diagnostic trouble codes according to Sections 5.3. and 5.6. of ISO DIS 15031-6. The fault codes must be fully accessible by standardised diagnostic equipment complying with the provisions of paragraph 6.5.3.2. of this Annex.

The vehicle manufacturer shall provide to a national standardisation body the details of any emission-related diagnostic data, e.g. PID's, OBD monitor Id's, Test Id's not specified in ISO DIS 15031-5 but related to this Regulation.

- 6.5.3.5. The connection interface between the vehicle and the diagnostic tester must be standardised and must meet all the requirements of ISO DIS 15031-3 “Road vehicles – Communication between vehicle and external test equipment for emissions-related diagnostics – Part 3: Diagnostic connector and related electrical circuits: specification and use”, dated 1 November 2001. The installation position must be subject to agreement of the administrative department such that it is readily accessible by service personnel but protected from tampering by non-qualified personnel.
- 6.5.3.6. The manufacturer shall also make accessible, where appropriate on payment, the technical information required for the repair or maintenance of motor vehicles unless that information is covered by an intellectual property right or constitutes essential, secret know-how which is identified in an appropriate form; in such case, the necessary technical information shall not be withheld improperly.
- Entitled to such information is any person engaged in commercially servicing or repairing, road-side rescuing, inspecting or testing of vehicles or in the manufacturing or selling replacement or retro-fit components, diagnostic tools and test equipment.
- 6.6. Specific requirements regarding the transmission of diagnostic signals from bi-fuelled gas vehicles.
- 6.6.1. For bi-fuelled gas vehicles, where the diagnostic signals of the different fuel systems are stored in the same computer, the diagnostic signals for the operation on petrol and for the operation on gas shall be evaluated and transmitted independently of each other.
- 6.6.2. For bi-fuelled gas vehicles, where the diagnostic signals of the different fuel systems are stored in separate computers, the diagnostic signals for the operation on petrol and for the operation on gas shall be evaluated and transmitted from the computer specific to the fuel.
- 6.6.3. On a request from a diagnostic tool, the diagnostic signals for the vehicle operating on petrol shall be transmitted on one source address and the diagnostic signals for the vehicle operating on gas shall be transmitted on another source address. The use of source addresses is described in ISO DIS 15031-5 “Road vehicles – Communication between vehicles and external test equipment for emissions-related diagnostics – Part 5: Emissions-related diagnostic services”, dated 1 November 2001.

Annex 11 - Appendix 2

ESSENTIAL CHARACTERISTICS OF THE VEHICLE FAMILY

1. PARAMETERS DEFINING THE OBD FAMILY

The OBD family may be defined by basic design parameters which shall be common to vehicles within the family. In some cases there may be interaction of parameters. These effects shall also be taken into consideration to ensure that only vehicles with similar exhaust emission characteristics are included within an OBD family.

2. To this end, those vehicle types whose parameters described below are identical are considered to belong to the same engine/emission control/OBD system combination.

Engine:

- (a) combustion process (i.e. positive-ignition, compression-ignition, two-stroke, four-stroke),
- (b) method of engine fuelling (i.e. carburettor or fuel injection).

Emission control system:

- (a) type of catalytic converter (i.e. oxidation, three-way, heated catalyst, other),
- (b) type of particulate trap,
- (c) secondary air injection (i.e. with or without),
- (d) exhaust gas recirculation (i.e. with or without)

OBD parts and functioning.

the methods of OBD functional monitoring, malfunction detection and malfunction indication to the vehicle driver.

Annex 12

GRANTING OF AN ECE TYPE APPROVAL FOR A VEHICLE FUELLED BY LPG OR NATURAL GAS (NG)

1. INTRODUCTION

This Annex describes the special requirements that apply in the case of an approval of a vehicle that runs on LPG or natural gas (NG), or that can run either on unleaded or LPG or natural gas, in so far as the testing on LPG or natural gas is concerned.

In the case of LPG and natural gas there is on the market a large variation in fuel composition, requiring the fuelling system to adapt its fuelling rates to these compositions. To demonstrate this capability, the vehicle has to be tested in the Type I test on two extreme reference fuels and demonstrate the self-adaptability of the fuelling system. Whenever the self adaptability of a fuelling system has been demonstrated on a vehicle, such a vehicle may be considered as a parent of a family. Vehicles that comply with the requirements of members of that family, if fitted with the same fuelling system, need to be tested on only one fuel.

2. DEFINITIONS

For the purpose of this Annex:

2.1. a "parent vehicle" means a vehicle that is selected to act as the vehicle on which the self-adaptability of a fuelling system is going to be demonstrated, and to which the members of a family refer. It is possible to have more than one parent vehicle in a family.

2.2. Member of the family

2.2.1. A "member of the family" is a vehicle that shares the following essential characteristics with its parent(s):

- (a) It is produced by the same manufacturer;
- (b) It is subject to the same emission limits;
- (c) If the gas fuelling system has a central metering for the whole engine:

it has a certified power output between 0.7 and 1.15 times that of the parent vehicle.

if the gas fuelling system has an individual metering per cylinder:

It has a certified power output per cylinder between 0.7 and 1.15 times that of the parent vehicle.

- (d) If fitted with a catalyst, it has the same type of catalyst i.e. three-way, oxidation, de-NO_x.
- (e) It has a gas fuelling system (including the pressure regulator) from the same system manufacturer and of the same type: induction, vapour injection (single point, multipoint), liquid injection (single point, multipoint).
- (f) This gas fuelling system is controlled by an ECU of the same type and technical specification, containing the same software principles and control strategy.

2.2.2. With regard to requirement (c) : in the case where a demonstration shows two gas-fuelled vehicles could be members of the same family with the exception of their certified power output, respectively P1 and P2 ($P1 < P2$), and both are tested as if were parent vehicles the family relation will be considered valid for any vehicle with a certified power output between 0.7 P1 and 1.15 P2.

3. GRANTING OF A TYPE APPROVAL

Type approval is granted subject to the following requirements:

3.1. Exhaust emissions approval of a parent vehicle

The parent vehicle should demonstrate its capability to adapt to any fuel composition that may occur across the market. In the case of LPG there are variations in C3/C4 composition. In the case of natural gas there are generally two types of fuel, high calorific fuel (H-gas) and low calorific fuel (L-gas), but with a significant spread within both ranges; they differ significantly in Wobbe index. These variations are reflected in the reference fuels.

3.1.1. The parent vehicle(s) shall be tested in the Type I test on the two extreme reference fuels of Annex 10a.

3.1.1.1. If the transition from one fuel to another is in practice aided through the use of a switch, this switch shall not be used during type approval. In such a case on the manufacturer's request and with the agreement of the technical service the pre-conditioning cycle referred to in paragraph 5.3.1. of Annex 4 may be extended.

3.1.2. The vehicle(s) is (are) considered to conform if, with both reference fuels, the vehicle complies with the emission limits.

3.1.3. The ratio of emission results “r” should be determined for each pollutant as shown below:

Type(s) of fuel	Reference fuels	Calculation of "r"
LPG and petrol (Approval B)	Fuel A	$r = \frac{B}{A}$
or LPB only (Approval D)	Fuel B	
NG and petrol (Approval B)	Fuel G 20	$r = \frac{G2}{G2_0}$
or NG only (Approval D)	Fuel G 25	

3.2. Exhaust emissions approval of a member of the family

For a member of the family a Type I test shall be performed with one reference fuel. This reference fuel may be either reference fuel. The vehicle is considered to comply if the following requirements are met:

- 3.2.1. the vehicle complies with the definition of a family member as defined under paragraph 2.2. above;
- 3.2.2. if the test fuel is reference fuel A for LPG or G20 for NG, the emission result shall be multiplied by the relevant factor “r” if $r > 1$; if $r < 1$, no correction is needed;
if the test fuel is reference fuel B for LPG or G25 for NG, the emission result shall be divided by the relevant factor “r” if $r < 1$; if $r > 1$, no correction is needed;
- 3.2.3. the vehicle shall comply with the emission limits valid for the relevant category for both measured and calculated emissions;
- 3.2.4. if repeated tests are made on the same engine the results on reference fuel G20, or A, and those on reference fuel G25, or B, shall first be averaged; the “r” factor shall then be calculated from these averaged results.

4. GENERAL CONDITIONS

- 4.1. Tests for conformity of production may be performed with a commercial fuel of which the C3/C4 ratio lies between those of the reference fuels in the case of LPG, or of which the Wobbe index lies between those of the extreme reference fuels in the case of NG. In that case a fuel analysis needs to be present.

Annex 13

EMISSIONS TEST PROCEDURE FOR A VEHICLE EQUIPPED WITH A PERIODICALLY REGENERATING SYSTEM

1. INTRODUCTION

This Annex defines the specific provisions regarding type-approval of a vehicle equipped with a periodically regenerating system as defined in paragraph 2.20. of this Regulation.

2. SCOPE AND EXTENSION OF THE TYPE APPROVAL

2.1. Vehicle family groups equipped with periodically regenerating system

The procedure applies to vehicles equipped with a periodically regenerating system as defined in paragraph 2.20. of this Regulation. For the purpose of this Annex vehicle family groups may be established. Accordingly, those vehicle types with regenerative systems, whose parameters described below are identical, or within the stated tolerances, shall be considered to belong to the same family with respect to measurements specific to the defined periodically regenerating systems.

2.1.1. Identical parameters are:

Engine:

- (a) combustion process

Periodically regenerating system (i.e. catalyst, particulate trap):

- (a) construction (i.e. type of enclosure, type of precious metal, type of substrate, cell density),
- (b) type and working principle,
- (c) dosage and additive system,
- (d) volume ± 10 per cent,
- (e) location (temperature ± 50 °C at 120 km/h or 5 per cent difference of max. temperature / pressure).

2.2. Vehicle types of different reference masses

The K_i factors developed by the procedures in this Annex for type approval of a vehicle type with a periodically regenerating system as defined in paragraph 2.20. of this Regulation, may be extended to other vehicles in the family group with a reference mass within the next two higher equivalent inertia classes or any lower equivalent inertia.

3. TEST PROCEDURE

The vehicle may be equipped with a switch capable of preventing or permitting the regeneration process provided that this operation has no effect on original engine calibration. This switch shall be permitted only for the purpose of preventing regeneration during loading of the regeneration system and during the pre-conditioning cycles. However, it shall not be used during the measurement of emissions during the regeneration phase; rather the emission test shall be carried out with the unchanged Original Equipment Manufacturer's (OEM) control unit.

3.1. Exhaust emission measurement between two cycles where regenerative phases occur

Average emissions between regeneration phases and during loading of the regenerative device shall be determined from the arithmetic mean of several approximately equidistant (if more than 2) Type I operating cycles or equivalent engine test bench cycles. As an alternative the manufacturer may provide data to show that the emissions remain constant (± 15 per cent) between regeneration phases. In this case, the emissions measured during the regular Type I test may be used. In any other case emissions measurement for at least two Type I operating cycles or equivalent engine test bench cycles must be completed: one immediately after regeneration (before new loading) and one as close as possible prior to a regeneration phase. All emissions measurements and calculations shall be carried out according to Annex 4, paragraphs 5., 6., 7. and 8.

3.1.2. The loading process and K_i determination shall be made during the Type I operating cycle, on a chassis dynamometer or on an engine test bench using an equivalent test cycle. These cycles may be run continuously (i.e. without the need to switch the engine off between cycles). After any number of completed cycles, the vehicle may be removed from the chassis dynamometer, and the test continued at a later time.

3.1.3. The number of cycles (D) between two cycles where regeneration phases occur, the number of cycles over which emissions measurements are made (n), and each emissions measurement (M'_{sij}) shall be reported in Annex 1, items 4.2.11.2.1.10.1. to 4.2.11.2.1.10.4. or 4.2.11.2.5.4.1. to 4.2.11.2.5.4.4. as applicable.

3.2. Measurement of emissions during regeneration

3.2.1. Preparation of the vehicle, if required, for the emissions test during a regeneration phase, may be completed using the preparation cycles in paragraph 5.3. of Annex 4 or equivalent engine test bench cycles, depending on the loading procedure chosen in paragraph 3.1.2. above.

3.2.2. The test and vehicle conditions for the Type 1 test described in Annex 4 apply before the first valid emission test is carried out.

- 3.2.3. Regeneration must not occur during the preparation of the vehicle. This may be ensured by one of the following methods:
- 3.2.3.1. A "dummy" regenerating system or partial system may be fitted for the pre-conditioning cycles.
- 3.2.3.2. Any other method agreed between the manufacturer and the type approval authority.
- 3.2.4. A cold-start exhaust emission test including a regeneration process shall be performed according to the Type I operating cycle, or equivalent engine test bench cycle. If the emissions tests between two cycles where regeneration phases occur are carried out on an engine test bench, the emissions test including a regeneration phase shall also be carried out on an engine test bench.
- 3.2.5. If the regeneration process requires more than one operating cycle, subsequent test cycle(s) shall be driven immediately, without switching the engine off, until complete regeneration has been achieved (each cycle shall be completed). The time necessary to set up a new test should be as short as possible (e.g. particular matter filter change). The engine must be switched off during this period.
- 3.2.6. The emission values during regeneration (M_{ri}) shall be calculated according to Annex 4, paragraph 8. The number of operating cycles (d) measured for complete regeneration shall be recorded.
- 3.3. Calculation of the combined exhaust emissions

$$M_{si} = \frac{\sum_{j=1}^n M'_{sij}}{n} \quad n \geq 2 \quad ; \quad M_{ri} = \frac{\sum_{j=1}^d M'_{rij}}{d}$$

$$M_{pi} = \left\{ \frac{M_{si} * D + M_{ri} * d}{D + d} \right\}$$

where for each pollutant (i) considered:

- M'_{sij} = mass emissions of pollutant (i) in g/km over one Type I operating cycle (or equivalent engine test bench cycle) without regeneration
- M'_{rij} = mass emissions of pollutant (i) in g/km over one Type I operating cycle (or equivalent engine test bench cycle) during regeneration. (when $n > 1$, the first Type I test is run cold, and subsequent cycles are hot)
- M_{si} = mean mass emission of pollutant (i) in g/km without regeneration
- M_{ri} = mean mass emission of pollutant (i) in g/km during regeneration
- M_{pi} = mean mass emission of pollutant (i) in g/km
- n = number of test points at which emissions measurements (Type I operating cycles or equivalent engine test bench cycles) are made between two cycles where regenerative phases occur, ≥ 2

d = number of operating cycles required for regeneration
 D = number of operating cycles between two cycles where regenerative phases occur

For exemplary illustration of measurement parameters see Figure 8/1.

Figure 8/1: Parameters measured during emissions test during and between cycles where regeneration occurs (schematic example, the emissions during 'D' may increase or decrease)

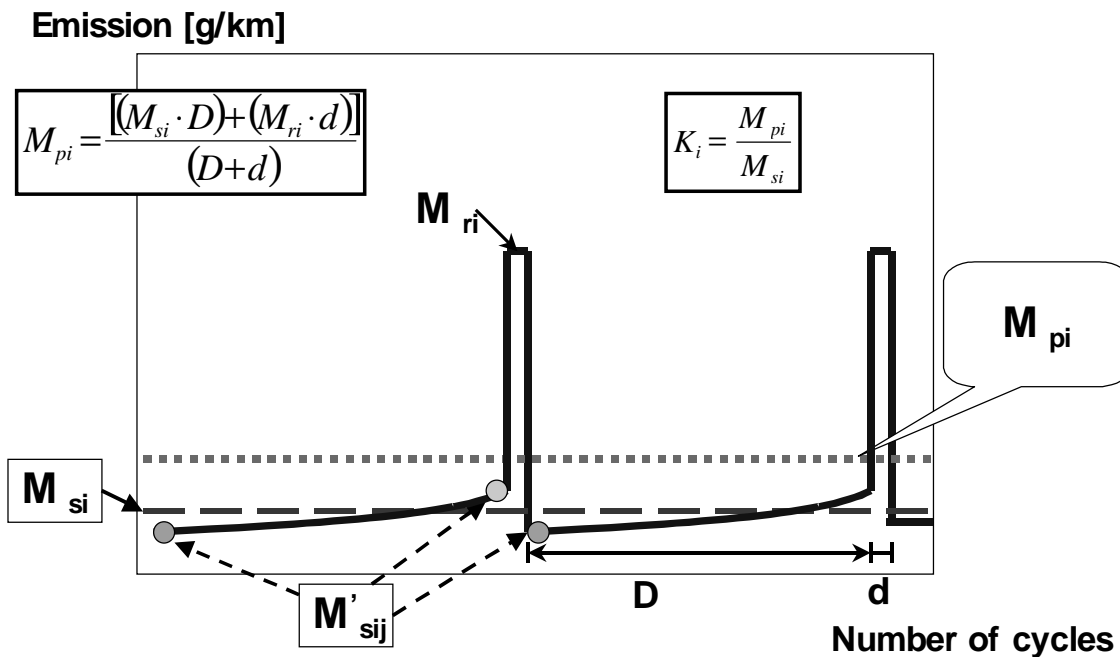

3.4. Calculation of the regeneration factor K for each pollutant (i) considered

$$K_i = M_{pi} / M_{si}$$

M_{si} , M_{pi} and K_i results shall be recorded in the test report delivered by the technical service.

K_i may be determined following the completion of a single sequence."

Annex 14**EMISSIONS TEST PROCEDURE FOR HYBRID ELECTRIC VEHICLES (HEV)****1. INTRODUCTION**

- 1.1. This Annex defines the specific provisions regarding type-approval of a hybrid electric vehicle (HEV) as defined in paragraph 2.21.2. of this Regulation.
- 1.2. As a general principle, for the tests of Type I, II, III, IV, V, VI and OBD, hybrid electric vehicles shall be tested according to Annex 4, 5, 6, 7, 9, 8 and 11 respectively, unless modified by this Annex.
- 1.3. For the Type I test only, OVC vehicles (as categorized in paragraph 2) shall be tested according to condition A and to condition B. The test results under both conditions A and B and the weighted values shall be reported in the communication form.
- 1.4. The emissions test results shall comply with the limits under all specified test conditions of this Regulation.

2. CATEGORIES OF HYBRID ELECTRIC VEHICLES

Vehicle charging	Off-Vehicle Charging (1) (OVC)		Not Off-Vehicle Charging (2) (NOVC)	
Operating mode switch	Without	With	Without	With

(1) also known as "externally chargeable"

(2) also known as "not externally chargeable"

3. TYPE I TEST METHODS**3.1. EXTERNALLY CHARGEABLE (OVC HEV) WITHOUT AN OPERATING MODE SWITCH**

- 3.1.1. Two tests shall be performed under the following conditions:

Condition A: test shall be carried out with a fully charged electrical energy/power storage device.

Condition B: test shall be carried out with an electrical energy/power storage device in minimum state of charge (maximum discharge of capacity).

The profile of the state of charge (SOC) of the electrical energy/power storage device during different stages of the Type I test is given in Appendix 1.

3.1.2. Condition A

3.1.2.1. The procedure shall start with the discharge of the electrical energy/power storage device of the vehicle while driving (on the test track, on a chassis dynamometer, etc.):

- at a steady speed of 50 km/h until the fuel consuming engine of the HEV starts up,
- or, if a vehicle cannot reach a steady speed of 50 km/h without starting up the fuel consuming engine, the speed shall be reduced until the vehicle can run a lower steady speed where the fuel consuming engine does not start up for a defined time/distance (to be specified between technical service and manufacturer),
- or with manufacturer's recommendation.

The fuel consuming engine shall be stopped within 10 seconds of it being automatically started.

3.1.2.2. Conditioning of vehicle

3.1.2.2.1. For compression-ignition engines the Part Two cycle described in Appendix 1 of Annex 4 shall be used. Three consecutive cycles shall be driven according to paragraph 3.1.2.5.3. below.

3.1.2.2.2. Vehicles fitted with positive-ignition engines shall be preconditioned with one Part One and two Part Two driving cycles according to paragraph 3.1.2.5.3. below.

3.1.2.3. After this preconditioning, and before testing, the vehicle shall be kept in a room in which the temperature remains relatively constant between 293 and 303 K (20 °C and 30 °C). This conditioning shall be carried out for at least six hours and continue until the engine oil temperature and coolant, if any, are within ± 2 K of the temperature of the room, and the electrical energy/power storage device is fully charged as a result of the charging prescribed in paragraph 3.1.2.4. below.

3.1.2.4. During soak, the electrical energy/power storage device shall be charged:

- (a) with the on board charger if fitted, or
- (b) with an external charger recommended by the manufacturer, using the normal overnight charging procedure.

This procedure excludes all types of special charges that could be automatically or manually initiated like, for instance, the equalization charges or the servicing charges.

The manufacturer shall declare that during the test, a special charge procedure has not occurred.

3.1.2.5. Test procedure

3.1.2.5.1. The vehicle shall be started up by the means provided for normal use to the driver. The first cycle starts on the initiation of the vehicle start-up procedure.

3.1.2.5.2. Sampling shall begin (BS) before or at the initiation of the vehicle start up procedure and end on conclusion of the final idling period in the extra-urban cycle (Part Two, end of sampling (ES)).

3.1.2.5.3. The vehicle shall be driven according to Annex 4, or in case of special gear shifting strategy according to the manufacturer's instructions, as incorporated in the drivers' handbook of production vehicles and indicated by a technical gear shift instrument (for drivers' information). For these vehicles the gear shifting points prescribed in Annex 4, Appendix 1 are not applied. For the pattern of the operating curve the description according to paragraph 2.3.3. in Annex 4 shall apply.

3.1.2.5.4. The exhaust gases shall be analyzed according to Annex 4.

3.1.2.6. The test results shall be compared to the limits prescribed in paragraph 5.3.1.4. of this Regulation and the average emission of each pollutant for Condition A shall be calculated ($M1_i$).

3.1.3. Condition B

3.1.3.1. Conditioning of vehicle

3.1.3.1.1. For compression-ignition engines the Part Two cycle described in Appendix 1 of Annex 4 shall be used. Three consecutive cycles shall be driven according to paragraph 3.1.3.4.3. below.

3.1.3.1.2. Vehicles fitted with positive-ignition engines shall be preconditioned with one Part One and two Part Two driving cycles according to paragraph 3.1.3.4.3. below.

3.1.3.2. The electrical energy/power storage device of the vehicle shall be discharged while driving (on the test track, on a chassis dynamometer, etc.):

- at a steady speed of 50 km/h until the fuel consuming engine of the HEV starts up,
- or if a vehicle can not reach a steady speed of 50 km/h without starting up the fuel consuming engine, the speed shall be reduced until the vehicle can run a lower steady speed where the fuel consuming engine just does not start up for a defined time/distance (to be specified between technical service and manufacturer),

- or with manufacturer's recommendation.

The fuel consuming engine shall be stopped within 10 seconds of it being automatically started.

- 3.1.3.3. After this preconditioning, and before testing, the vehicle shall be kept in a room in which the temperature remains relatively constant between 293 and 303 K (20 °C and 30° C). This conditioning shall be carried out for at least six hours and continue until the engine oil temperature and coolant, if any, are within ± 2 K of the temperature of the room.
- 3.1.3.4. Test procedure
 - 3.1.3.4.1. The vehicle shall be started up by the means provided for normal use to the driver. The first cycle starts on the initiation of the vehicle start-up procedure.
 - 3.1.3.4.2. Sampling shall begin (BS) before or at the initiation of the vehicle start up procedure and end on conclusion of the final idling period in the extra-urban cycle (Part Two, end of sampling (ES)).
 - 3.1.3.4.3. The vehicle shall be driven according to Annex 4, or in case of special gear shifting strategy according to the manufacturer's instructions, as incorporated in the drivers' handbook of production vehicles and indicated by a technical gear shift instrument (for drivers' information). For these vehicles the gear shifting points prescribed in Annex 4, Appendix 1 are not applied. For the pattern of the operating curve the description according to paragraph 2.3.3. in Annex 4 shall apply.
 - 3.1.3.4.4. The exhaust gases shall be analyzed according to Annex 4.
- 3.1.3.5. The test results shall be compared to the limits prescribed in paragraph 5.3.1.4. of this Regulation and the average emission of each pollutant for Condition B shall be calculated (M_{2i}).
- 3.1.4. Test results
 - 3.1.4.1. For communication, the weighted values shall be calculated as below:

$$M_i = (De A M_{1i} + Dav A M_{2i}) / (De + Dav)$$

Where:

- M_i = mass emission of the pollutant i in grams per kilometre.
- $M1_i$ = average mass emission of the pollutant i in grams per kilometre with a fully charged electrical energy/power storage device calculated in paragraph 3.1.2.6.
- $M2_i$ = average mass emission of the pollutant i in grams per kilometre with an electrical energy/power storage device in minimum state of charge (maximum discharge of capacity) calculated in paragraph 3.1.3.5.
- D_e = vehicle electric range, according to the procedure described in Regulation No. 101, Annex 7, where the manufacturer must provide the means for performing the measurement with the vehicle running in pure electric mode.
- D_{av} = 25 km (average distance between two battery recharges)

3.2. EXTERNALLY CHARGEABLE (OVC HEV) WITH AN OPERATING MODE SWITCH

3.2.1. Two tests shall be performed under the following conditions:

- 3.2.1.1. Condition A: test shall be carried out with a fully charged electrical energy/power storage device.
- 3.2.1.2. Condition B: test shall be carried out with an electrical energy/power storage device in minimum state of charge (maximum discharge of capacity)

3.2.1.3. The operating mode switch shall be positioned according the table below:

Hybrid-modes Battery state of charge	-Pure electric -Hybrid Switch in position	-Pure fuel consuming -Hybrid Switch in position	-Pure electric -Pure fuel consuming -Hybrid Switch in position	-Hybrid mode n (1) -Hybrid mode m (1) Switch in position
Condition A Fully charged	Hybrid	Hybrid	Hybrid	Most electric hybrid mode (2)
Condition B Min. state of charge	Hybrid	Fuel consuming	Fuel consuming	Most fuel consuming mode (3)

(1) For instance: sport, economic, urban, extra-urban position ...

(2) Most electric hybrid mode:

The hybrid mode which can be proven to have the highest electricity consumption of all selectable hybrid modes when tested in accordance with condition A of paragraph 4. of Annex 10 to Regulation No. 101, to be established based on information provided by the manufacturer and in agreement with the technical service.

(3) Most fuel consuming mode:

The hybrid mode which can be proven to have the highest fuel consumption of all selectable hybrid modes when tested in accordance with condition B of paragraph 4. of Annex 10 to Regulation No. 101, to be established based on information provided by the manufacturer and in agreement with the technical service.

3.2.2. Condition A

3.2.2.1. If the pure electric range of the vehicle is higher than one complete cycle, on the request of the manufacturer, the Type I test may be carried out in pure electric mode. In this case, engine preconditioning prescribed in paragraph 3.2.2.3.1. or 3.2.2.3.2. can be omitted.

3.2.2.2. The procedure shall start with the discharge of the electrical energy/power storage device of the vehicle while driving with the switch in pure electric position (on the test track, on a chassis dynamometer, etc.) at a steady speed of 70 per cent \pm 5 per cent of the maximum thirty minutes speed of the vehicle (determined according to Regulation No. 101).

Stopping the discharge occurs:

- when the vehicle is not able to run at 65 per cent of the maximum thirty minutes speed; or
- when an indication to stop the vehicle is given to the driver by the standard on-board instrumentation, or
- after covering the distance of 100 km.

If the vehicle is not equipped with a pure electric mode, the electrical energy/power storage device discharge shall be achieved by driving the vehicle (on the test track, on a chassis dynamometer, etc.):

- at a steady speed of 50 km/h until the fuel consuming engine of the HEV starts up, or
- if a vehicle cannot reach a steady speed of 50 km/h without starting up the fuel consuming engine, the speed shall be reduced until the vehicle can run a lower steady speed where the fuel consuming engine does not start up for a defined time/distance (to be specified between technical service and manufacturer), or
- with manufacturer's recommendation.

The fuel consuming engine shall be stopped within 10 seconds of it being automatically started.

3.2.2.3. Conditioning of vehicle

3.2.2.3.1. For compression-ignition engines the Part Two cycle described in Appendix 1 to the Annex 4 shall be used. Three consecutive cycles shall be driven according to paragraph 3.2.2.6.3. below.

3.2.2.3.2. Vehicles fitted with positive-ignition engines shall be preconditioned with one Part One and two Part Two driving cycles according to paragraph 3.2.2.6.3. below.

3.2.2.4. After this preconditioning, and before testing, the vehicle shall be kept in a room in which the temperature remains relatively constant between 293 and 303 K (20 °C and 30 °C). This conditioning shall be carried out for at least six hours and continue until the engine oil temperature and coolant, if any, are within ± 2 K of the temperature of the room, and the electrical energy/power storage device is fully charged as a result of the charging prescribed in paragraph 3.2.2.5.

3.2.2.5. During soak, the electrical energy/power storage device shall be charged:

- (a) with the on board charger if fitted, or
- (b) with an external charger recommended by the manufacturer, using the normal overnight charging procedure.

This procedure excludes all types of special charges that could be automatically or manually initiated like, for instance, the equalisation charges or the servicing charges.

The manufacturer shall declare that during the test, a special charge procedure has not occurred.

- 3.2.2.6. Test procedure
- 3.2.2.6.1. The vehicle shall be started up by the means provided for normal use to the driver. The first cycle starts on the initiation of the vehicle start-up procedure.
- 3.2.2.6.2. Sampling shall begin (BS) before or at the initiation of the vehicle start up procedure and end on conclusion of the final idling period in the extra-urban cycle (Part Two, end of sampling (ES)).
- 3.2.2.6.3. The vehicle shall be driven according to Annex 4, or in case of special gear shifting strategy according to the manufacturer's instructions, as incorporated in the drivers' handbook of production vehicles and indicated by a technical gear shift instrument (for drivers information). For these vehicles the gear shifting points prescribed in Annex 4, Appendix 1 are not applied. For the pattern of the operating curve the description according to paragraph 2.3.3. in Annex 4 shall apply.
- 3.2.2.6.4. The exhaust gases shall be analysed according to Annex 4.
- 3.2.2.7. The test results shall be compared to the limits prescribed in paragraph 5.3.1.4. of this Regulation and the average emission of each pollutant for Condition A shall be calculated ($M1_i$).
- 3.2.3. Condition B
- 3.2.3.1. Conditioning of vehicle
- 3.2.3.1.1. For compression-ignition engines the Part Two cycle described in Appendix 1 to the Annex 4 shall be used. Three consecutive cycles shall be driven according to paragraph 3.2.3.4.3. below.
- 3.2.3.1.2. Vehicles fitted with positive-ignition engines shall be preconditioned with one Part One and two Part Two driving cycles according to paragraph 3.2.3.4.3. below.
- 3.2.3.2. The electrical energy/power storage device of the vehicle shall be discharged according to paragraph 3.2.2.2.
- 3.2.3.3. After this preconditioning, and before testing, the vehicle shall be kept in a room in which the temperature remains relatively constant between 293 and 303 K (20 °C and 30 °C). This conditioning shall be carried out for at least six hours and continue until the engine oil temperature and coolant, if any, are within ± 2 K of the temperature of the room.
- 3.2.3.4. Test procedure
- 3.2.3.4.1. The vehicle shall be started up by the means provided for normal use to the driver. The first cycle starts on the initiation of the vehicle start-up procedure.

- 3.2.3.4.2. Sampling shall begin (BS) before or at the initiation of the vehicle start up procedure and end on conclusion of the final idling period in the extra-urban cycle (Part Two, end of sampling (ES)).
- 3.2.3.4.3. The vehicle shall be driven according to Annex 4, or in case of special gear shifting strategy according to the manufacturer's instructions, as incorporated in the drivers' handbook of production vehicles and indicated by a technical gear shift instrument (for drivers' information). For these vehicles the gear shifting points prescribed in Annex 4, Appendix 1 are not applied. For the pattern of the operating curve the description according to paragraph 2.3.3. in Annex 4 shall apply.
- 3.2.3.4.4. The exhaust gases shall be analysed according to Annex 4.
- 3.2.3.5. The test results shall be compared to the limits prescribed in paragraph 5.3.1.4. of this Regulation and the average emission of each pollutant for Condition B shall be calculated (M_{2i}).
- 3.2.4. Test results
- 3.2.4.1. For communication, the weighted values shall be calculated as below:
- $$M_i = (De A M_{1i} + Dav A M_{2i}) / (De + Dav)$$
- Where :
- M_i = mass emission of the pollutant i in grams per kilometre
- M_{1i} = average mass emission of the pollutant i in grams per kilometre with a fully charged electrical energy/power storage device calculated in paragraph 3.2.2.7.
- M_{2i} = average mass emission of the pollutant i in grams per kilometre with an electrical energy/power storage device in minimum state of charge (maximum discharge of capacity) calculated in paragraph 3.2.3.5.
- De = vehicle electric range with the switch in pure electric position, according to the procedure described in Regulation No. 101, Annex 7. If there is not a pure electric position, the manufacturer must provide the means for performing the measurement with the vehicle running in pure electric mode.
- Dav = 25 km (average distance between two battery recharge)
- 3.3. NOT EXTERNALLY CHARGEABLE (NOTOVC HEV) WITHOUT AN OPERATING MODE SWITCH
- 3.3.1. These vehicles shall be tested according to Annex 4.
- 3.3.2. For preconditioning, at least two consecutive complete driving cycles (one Part One and one Part Two) are carried out without soak.

- 3.3.3. The vehicle shall be driven according to Annex 4, or in case of special gear shifting strategy according to the manufacturer's instructions, as incorporated in the drivers' handbook of production vehicles and indicated by a technical gear shift instrument (for drivers' information). For these vehicles the gear shifting points prescribed in Annex 4, Appendix 1 are not applied. For the pattern of the operating curve the description according to paragraph 2.3.3. in Annex 4 shall apply.
- 3.4. NOT EXTERNALLY CHARGEABLE (NOTOVC HEV) WITH AN OPERATING MODE SWITCH
- 3.4.1. These vehicles are preconditioned and tested in hybrid mode according to Annex 4. If several hybrid modes are available, the test shall be carried out in the mode that is automatically set after turn on of the ignition key (normal mode). On the basis of information provided by the manufacturer, the Technical Service will make sure that the limit values are met in all hybrid modes.
- 3.4.2. For preconditioning, at least two consecutive complete driving cycles (one Part One and one Part Two) shall be carried out without soak.
- 3.4.3. The vehicle shall be driven according to Annex 4, or in case of special gear shifting strategy according to the manufacturer's instructions, as incorporated in the drivers' handbook of production vehicles and indicated by a technical gear shift instrument (for drivers' information). For these vehicles the gear shifting points prescribed in Annex 4, Appendix 1 are not applied. For the pattern of the operating curve the description according to paragraph 2.3.3. in Annex 4 shall apply.
4. TYPE II TEST METHODS
- 4.1. The vehicles shall be tested according to Annex 5 with the fuel consuming engine running. The manufacturer shall provide a "service mode" that makes execution of this test possible.
- If necessary, the special procedure provided for in paragraph 5.1.6. to the Regulation shall be used.
5. TYPE III TEST METHODS
- 5.1. The vehicles shall be tested according to Annex 6 with the fuel consuming engine running. The manufacturer shall provide a "service mode" that makes execution of this test possible.
- 5.2. The tests shall be carried out only for conditions 1 and 2 of paragraph 3.2. of Annex 6. If for any reasons it is not possible to test on condition 2, alternatively another steady speed condition (with fuel consuming engine running under load) should be carried out.

6. TYPE IV TEST METHODS

6.1. The vehicles shall be tested according to Annex 7.

6.2. Before starting the test procedure (paragraph 5.1. of Annex 7), the vehicles shall be preconditioned as follows:

6.2.1. For OVC vehicles:

6.2.1.1. OVC vehicles without an operating mode switch: the procedure shall start with the discharge of the electrical energy/power storage device of the vehicle while driving (on the test track, on a chassis dynamometer, etc.):

- at a steady speed of 50 km/h until the fuel consuming engine of the HEV starts up, or
- if a vehicle cannot reach a steady speed of 50 km/h without starting up the fuel consuming engine, the speed shall be reduced until the vehicle can run a lower steady speed where the fuel consuming engine just does not start up for a defined time/distance (to be specified between technical service and manufacturer), or
- with manufacturer's recommendation.

The fuel consuming engine shall be stopped within 10 seconds of it being automatically started.

6.2.1.2. OVC vehicles with an operating mode switch: the procedure shall start with the discharge of the electrical energy/power storage device of the vehicle while driving with the switch in pure electric position (on the test track, on a chassis dynamometer, etc.) at a steady speed of 70 per cent \pm 5 per cent from the maximum thirty minutes speed of the vehicle.

Stopping the discharge occurs:

- when the vehicle is not able to run at 65 per cent of the maximum thirty minutes speed, or
- when an indication to stop the vehicle is given to the driver by the standard on-board instrumentation, or
- after covering the distance of 100 km.

If the vehicle is not equipped with a pure electric mode, the electrical energy/power storage device discharge shall be conducted with the vehicle driving (on the test track, on a chassis dynamometer, etc.):

- at a steady speed of 50 km/h until the fuel consuming engine of the HEV starts up, or
- if a vehicle cannot reach a steady speed of 50 km/h without starting up the fuel consuming engine, the speed shall be reduced until the vehicle can run a lower steady speed where the fuel consuming engine does not start up for a defined time/distance (to be specified between technical service and manufacturer), or
- with manufacturer's recommendation.

The engine shall be stopped within 10 seconds of it being automatically started.

6.2.2. For NOVC vehicles:

6.2.2.1. NOVC vehicles without an operating mode switch: the procedure shall start with a preconditioning of at least two consecutive complete driving cycles (one Part One and one Part Two) without soak.

6.2.2.2. NOVC vehicles with an operating mode switch: the procedure shall start with a preconditioning of at least two consecutive complete driving cycles (one Part One and one Part Two) without soak, performed with the vehicle running in hybrid mode. If several hybrid modes are available, the test shall be carried out in the mode which is automatically set after turn on of the ignition key (normal mode).

6.3. The preconditioning drive and the dynamometer test shall be carried out according to paragraphs 5.2. and 5.4. of Annex 7:

6.3.1. For OVC vehicles: under the same conditions as specified by Condition B of the Type I test (paragraphs 3.1.3. and 3.2.3.).

6.3.2. For NOVC vehicles: under the same conditions as in the Type I test.

7. TYPE V TEST METHODS

7.1. The vehicles shall be tested according to Annex 9.

7.2. For OVC vehicles:

It is allowed to charge the electrical energy/power storage device twice a day during mileage accumulation.

For OVC vehicles with an operating mode switch, mileage accumulation should be driven in the mode which is automatically set after turn on of the ignition key (normal mode).

During the mileage accumulation a change into another hybrid mode is allowed if necessary in order to continue the mileage accumulation after agreement of the technical service.

The measurements of emissions of pollutants shall be carried out under the same conditions as specified by Condition B of the Type I test (paragraphs 3.1.3. and 3.2.3.).

7.3. For NOVC vehicles:

For NOVC vehicles with an operating mode switch, mileage accumulation shall be driven in the mode which is automatically set after turn on of the ignition key (normal mode).

The measurements of emissions of pollutants shall be carried out in the same conditions as in the Type I test.

8. TYPE VI TEST METHODS

8.1. The vehicles shall be tested according to Annex 8.

8.2. For OVC vehicles, the measurements of emissions of pollutants shall be carried out under the same conditions as specified for Condition B of the Type I test (paragraphs 3.1.3. and 3.2.3.).

8.3. For NOVC vehicles, the measurements of emissions of pollutants shall be carried out under the same conditions as in the Type I test.

9. ON BOARD DIAGNOSTICS (OBD) TEST METHODS

9.1. The vehicles shall be tested according to Annex 11.

9.2. For OVC vehicles, the measurements of emissions of pollutants shall be carried out under the same conditions as specified for Condition B of the Type I test (paragraphs 3.1.3. and 3.2.3.).

9.3. For NOVC vehicles, the measurements of emissions of pollutants shall be carried out under the same conditions as in the Type I test.

Annex 14 Appendix 1

ELECTRICAL ENERGY/POWER STORAGE DEVICE STATE OF CHARGE (SOC) PROFILE FOR OVC HEV TYPE I TEST

Condition A of the Type I test

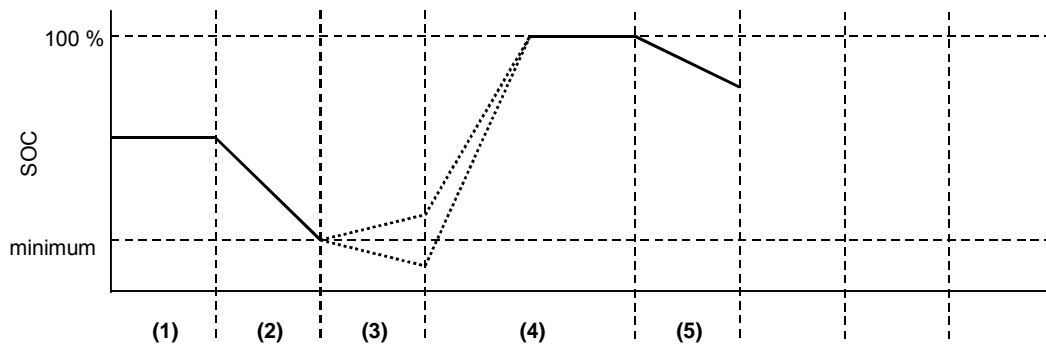

Condition A:

- (1) initial electrical energy/power storage device state of charge
- (2) discharge according to paragraph 3.1.2.1. or 3.2.2.1.
- (3) vehicle conditioning according to paragraph 3.1.2.2. or 3.2.2.2.
- (4) charge during soak according to paragraphs 3.1.2.3. and 3.1.2.4., or paragraphs 3.2.2.3. and 3.2.2.4.
- (5) test according to paragraph 3.1.2.5. or 3.2.2.5.

Condition B of the Type I test

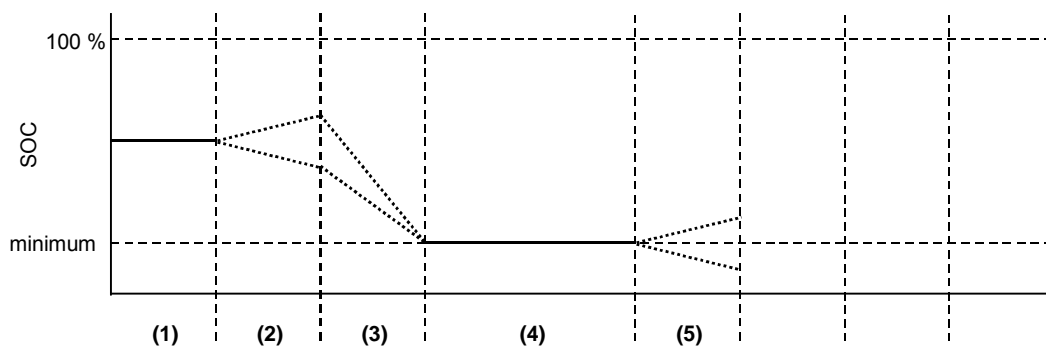

Condition B:

- (1) initial state of charge
- (2) vehicle conditioning according to paragraph 3.1.3.1. or 3.2.3.1.
- (3) discharge according to paragraph 3.1.3.2. or 3.2.3.2.
- (4) soak according to paragraph 3.1.3.3. or 3.2.3.3.
- (5) test according to paragraph 3.1.3.4. or 3.2.3.4.

A

analytical equipment 97, 205
 approval 1, 2, 12, 13, 83, 235, 248, 249, 251
 approval of a vehicle 10
 arrangements of the approval mark 89

B

bi-fuel vehicle 12
 bodywork 82

C

calculated load value 227
 calibrating the dynamometer 120
 calibration of the cvs system 158
 calibration of the hydrocarbon analyzer 201
 categories of hybrid electric vehicles 255
 chassis dynamometer 120, 127, 213
 cold start device 9
 communication 83
 compression-ignition engines 172
 conditioning of vehicle 104, 256, 257, 261, 262
 confirmation or refusal of approval 29
 conformity of in-service vehicles 34
 conformity of production 33, 49, 52, 195
 critical-flow venturi 147, 150, 151, 152, 162, 163
 critical-flow venturi dilution device 147

D

defeat device 10
 deficiency 228, 236
 determination of the quantity of gaseous 108
 diesel engines 219, 221
 driving cycle 25, 31, 76, 77, 86, 88, 97, 104, 145, 152,
 181, 191, 192, 206, 208, 212, 227, 233, 234, 236,
 256, 257, 261, 262, 263, 264, 266
 durability of anti-pollution devices 26, 31
 dynamometer 210
 dynamometer procedure 210

E

electrical energy/power storage device 268
 electronic system security 16
 emission control system 226, 247
 emission data 27
 emissions test procedure for hybrid electric vehicles
 (hev) 255
 energy converters 68
 engine and vehicle characteristics 67
 engine capacity 9, 68
 engine crankcase 9
 engine misfire 227, 230
 evaporative emissions 9, 31, 184
 evaporative emissions and fuel spillage 16
 evaporative test 182
 exhaust emission related extensions 29
 exhaust emissions 7, 9, 184, 191, 249, 250

exhaust gas-sampling system 96
 extension of approval 29
 externally chargeable (ovc hev) 255, 259

F

family of vehicles 10
 fid hydrocarbon 155, 201
 fuel requirement by the engine 10
 fuel trim 227

G

gaseous pollutants 8, 9, 11, 15, 83, 89, 90, 91, 166
 gas-sampling 137
 general construction characteristics of the vehicle 67

H

hot soak losses 9
 hybrid electric 11, 81, 83
 hybrid vehicles 11

I

ice-trap 99
 inertias 135
 information concerning the conduct of tests 67
 Inlet orifices of petrol tanks 15
 in-service conformity check 55
 in-service test 9
 in-service testing 57
 ISO 2575
 1982 16
 ISO DIS 15031-4 245
 ISO DIS 15031-5 245, 246
 ISO DIS 15031-7 16

M

malfunction indicator (mi) 226
 mass emissions of pollutants 166
 maximum mass 8, 84
 measuring emissions of pollutants 216
 measuring exhaust-gas emissions 137
 method of calibrating the equipment 154
 modifications of the vehicle type 29
 mono-fuel vehicle 11

N

no humidity correction factor 168
 not externally chargeable (notovc hev) 264
 no_x converter 156

O

obd 7, 9, 12, 13, 17, 18, 29, 33, 36, 40, 46, 47, 55, 56,
 57, 76, 77, 86, 88, 226, 227, 228, 229, 230, 231,
 232, 233, 234, 235, 237, 239, 240, 242, 244, 245,
 247, 255
 obd – related information 88
 OBD – test 29
 OBD test procedure 240

on board diagnostics (obd) test methods	267
on-board diagnostics	20, 33, 40
operating cycle on the chassis dynamometer	92

P

particulate pollutants	8
particulate pollutants emitted	108
penalties for non-conformity of production	43
periodically regenerating system	11, 251
permanent emission default mode	227
pollution control devices	9
positive displacement pump	145, 146, 147, 149, 158, 167
positive-ignition engines	218, 220, 222
power take-off unit	227
procedure for bench tests	105
procedure for verifying	49, 52
production definitely discontinued	43, 83
properly maintained and used	10

R

reference mass	8, 21, 84, 103, 126, 231
regulation no. 83	1, 2, 83, 89, 90, 91, 238
requirements and tests	229
revision 2	1

S

secondary air	226
services responsible for conducting approval tests	48
setting of the dynamometer	124
starting aid	9
statistical procedure for in-service conformity testing	60
suspension	81

T

tank breathing losses	9
test equipment	95, 182, 204, 240

test procedure	17, 129, 132, 133, 134, 206, 257, 258, 262
----------------	--

total system verification	165
transitional provisions	44
transmission	80

Type I test	11, 12, 14, 18, 25, 27, 33, 37, 41, 44, 49, 52, 60, 74, 84, 89, 90, 91, 92, 112, 115, 117, 119, 174, 177, 184, 191, 204, 213, 216, 218, 219, 220, 221, 227, 231, 232, 239, 240, 241, 242, 248, 249, 250, 252, 253, 255, 260, 266, 267, 268
-------------	--

Type II test	22, 27, 174, 175, 177
--------------	-----------------------

type ii test methods	264
----------------------	-----

Type III test	22, 23, 40, 177
---------------	-----------------

type iii test methods	264
-----------------------	-----

Type IV test	25, 31, 40, 181
--------------	-----------------

type iv test methods	265
----------------------	-----

Type V test	26, 27, 31
-------------	------------

type v test methods	266
---------------------	-----

Type VI test	10, 25, 29, 30, 46, 204, 205, 222
--------------	-----------------------------------

type vi test methods	267
----------------------	-----

U

united kingdom (e11)	89, 90, 91
----------------------	------------

unladen mass	7, 8, 84
--------------	----------

V

variable-dilution system	137
--------------------------	-----

vehicle and fuel	94, 181, 240
------------------	--------------

vehicle for roadworthiness	17
----------------------------	----

vehicle preconditioning	208
-------------------------	-----

vehicle type	8, 29, 30, 83, 226, 251
--------------	-------------------------

vehicle types	29, 30, 251
---------------	-------------

volume measurement	101, 140
--------------------	----------

W

warm-up cycle	227, 234, 236
---------------	---------------