



# Australian Government

---

## Civil Aviation Safety Authority

### **Part 139 (Aerodromes) Manual of Standards 2019 (as amended)**

made under regulation 139.005 of the *Civil Aviation Safety Regulations 1998* and section 4 of the *Acts Interpretation Act 1901*.

#### **Compilation No. 2**

**Compilation date:** 10 February 2024

**Includes amendments up to:** F2024L00152

Prepared by the Advisory and Drafting Branch, Legal, International and Regulatory Affairs  
Division, Civil Aviation Safety Authority, Canberra.

## About this compilation

### This compilation

This is a compilation of the *Part 139 (Aerodromes) Manual of Standards* 2019 that shows the text of the law as amended and in force on 10 February 2024.

The notes at the end of this compilation (the *endnotes*) include information about the amending laws and the amendment history of provisions of the compiled law.

# Contents

Note This Table of Contents is not part of the *Part 139 (Aerodromes) Manual of Standards 2019* (the **MOS**). It is for guidance only and may be modified or edited in any published version of this instrument. See section 1.09 of the MOS.

	Page
<b>CHAPTER 1 PRELIMINARY .....</b>	<b>1</b>
<i>Division 1 General .....</i>	<i>1</i>
1.01 Name.....	1
1.02 Commencement.....	1
1.03 Purpose .....	1
1.04 Application .....	1
1.05 Conflict between this MOS and an incorporated document.....	1
1.06 Tables, Figures and Notes .....	1
1.07 References to ICAO and other documents .....	2
1.08 References to intended, nominated, preferred and “should” in a Note .....	2
1.09 Table of Contents .....	3
<i>Division 2 Empowerments.....</i>	<i>4</i>
1.10 General power to make a Part 139 Manual of Standards .....	4
1.11 Specific regulations for which MOS provisions have been made.....	4
<b>CHAPTER 1A TRANSITIONAL PROVISIONS.....</b>	<b>8</b>
<i>Division 1 General .....</i>	<i>8</i>
1A.01 Application .....	8
<i>Division 2 Technical inspection programs.....</i>	<i>8</i>
1A.02 Technical inspection programs.....	8
<i>Division 3 Annual aerodrome manual validation and report .....</i>	<i>8</i>
1A.03 Annual aerodrome manual validation and report .....	8
<i>Division 4 Wildlife hazard management plans.....</i>	<i>9</i>
1A.04 Wildlife hazard management plans .....	9
<i>Division 5 Aerodrome emergency plans.....</i>	<i>9</i>
1A.05 Aerodrome emergency plans.....	9
<i>Division 6 Requirement for an SMS.....</i>	<i>9</i>
1A.06 Requirement for an SMS (registered aerodromes).....	9
<i>Division 7 Requirement for an SMS (certified aerodromes with scheduled international air transport operations) .....</i>	<i>9</i>
1A.07 Requirement for an SMS .....	9
<i>Division 8 Risk management plans.....</i>	<i>10</i>
1A.08 Risk management plans.....	10
<b>CHAPTER 2 APPLICATION OF STANDARDS .....</b>	<b>11</b>
2.01 Definitions .....	11
2.02 Application — new aerodromes .....	12
2.03 Application — Chapter 22.....	12
2.04 Application — existing aerodromes etc. ....	12
2.04A Application — grandfathering of new aerodrome facility developments .....	13

2.05	Directions to upgrade a part of an existing aerodrome or facility .....	15
2.06	Non-application of the standards .....	16
<b>CHAPTER 3</b>	<b>DEFINITIONS ETC.....</b>	<b>18</b>
3.01	Definitions etc. ....	18
<b>CHAPTER 4</b>	<b>AERODROME REFERENCE CODE AND DETERMINATION OF AERODROME STANDARDS.....</b>	<b>36</b>
4.01	Aerodrome Reference Code .....	36
<b>CHAPTER 5</b>	<b>AERODROME INFORMATION FOR THE AIP AND THE AERODROME MANUAL.....</b>	<b>38</b>
<i>Division 1</i>	<i>Information .....</i>	<i>38</i>
5.01	Information for the AIP through an AIS provider.....	38
5.02	Information to be included in aerodrome manual .....	38
5.03	Aerodrome information .....	38
5.04	Movement area information .....	39
5.05	Visual aids .....	41
5.06	Navigation aids.....	41
5.07	Rescue and firefighting services.....	41
5.08	Ground services .....	41
5.09	Aerodrome operational procedures .....	42
<i>Division 2</i>	<i>Standards for information.....</i>	<i>43</i>
5.10	Standards for information published in the AIP through an AIS provider.....	43
5.11	Standards for information to be included in aerodrome manual .....	43
5.12	Movement area – runways – declared distances information.....	43
5.13	Movement area — taxiways .....	46
5.14	Movement area — aprons .....	47
5.15	Visual aids .....	47
5.16	Navigation aids.....	48
5.17	Additional hazard information .....	48
<b>CHAPTER 6</b>	<b>AERODROME PLANNING, DESIGN AND MAINTENANCE — PHYSICAL CHARACTERISTICS OF MOVEMENT FACILITIES.....</b>	<b>49</b>
<i>Division 1</i>	<i>Runways .....</i>	<i>49</i>
6.01	Location of runway threshold.....	49
6.02	Runway width.....	49
6.03	Runway turn pad and runway bypass pad .....	50
6.04	Runway starter extension .....	52
6.05	Parallel runways .....	52
6.06	Runway longitudinal slope .....	53
6.07	Runway sight distance .....	55
6.08	Transverse slopes on runways .....	55
6.09	Runway surface .....	56
6.10	Runway bearing strength.....	58
6.11	Runway shoulders .....	58
6.12	Characteristics of runway shoulders.....	59
6.13	Transverse slope on runway shoulder .....	59
6.14	Provision of runway strip .....	60
6.15	Composition of runway strip .....	60

6.16	Runway strip length.....	60
6.17	Runway strip width.....	61
6.18	Longitudinal slope on graded area of runway strip .....	63
6.19	Longitudinal slope changes on graded area of runway strip .....	63
6.20	Radio altimeter operating area.....	63
6.21	Runway strip transverse slope .....	63
6.22	Surface of graded area of runway strips .....	64
6.23	Composition of runway strips .....	64
6.24	Objects or structures on runway strips .....	65
6.25	Runway strip availability.....	65
6.26	Runway end safety area (RESA).....	65
6.27	Clearways .....	66
6.28	Location of clearways.....	66
6.29	Dimensions of clearways.....	66
6.30	Slopes on clearways .....	67
6.31	Objects or structures on clearways .....	67
6.32	Stopways.....	67
6.33	Dimensions of stopways.....	67
6.34	Surface of stopways.....	67
6.35	Stopway slopes and slope changes .....	67
6.36	Bearing strength of stopways .....	67
<i>Division 2 Taxiways .....</i>		<i>68</i>
6.37	Taxiway width .....	68
6.38	Taxiway edge clearance.....	69
6.39	Taxiway curves.....	69
6.40	Taxiway longitudinal slope .....	69
6.41	Taxiway transverse slope .....	70
6.42	Taxiway sight distance .....	70
6.43	Taxiway bearing strength .....	71
6.44	Taxiway shoulders.....	71
6.45	Width of taxiway shoulders.....	71
6.46	Surface of taxiway shoulders.....	71
6.47	Taxiway strips .....	72
6.48	Width of taxiway strip .....	72
6.49	Width of graded area of taxiway strip .....	73
6.50	Slope of taxiway strip .....	73
6.51	Objects or structures on a taxiway strip.....	73
6.52	Taxiways on bridges.....	74
6.53	Taxiway minimum separation distances.....	74
<i>Division 3 Holding bays, runway holding positions, intermediate holding positions and road-holding positions .....</i>		<i>78</i>
6.54	Provision of a holding bay, runway holding position, intermediate holding position and road-holding position.....	78
6.55	Location of a holding bay, runway holding position, intermediate holding position or road-holding position.....	78
6.56	Distance from runway holding position, intermediate holding position or road-holding position, to runway centreline .....	78
<i>Division 4 Aprons .....</i>		<i>80</i>
6.57	Location of apron .....	80
6.58	Separation distances on aprons.....	80

6.59	Alternative aircraft parking position separation .....	81
6.60	Slopes on aprons .....	81
6.61	Apron bearing strength .....	82
6.62	Apron roads .....	82
<i>Division 5 Blast and wash from aircraft propulsion systems .....</i>		<i>83</i>
6.63	General .....	83
6.64	Jet blast, propeller wash and rotor wash air velocity .....	83
<i>Division 6 Glider facilities .....</i>		<i>84</i>
6.65	General .....	84
6.66	Dimensions of glider runway strips .....	84
6.67	Glider parking areas .....	85
6.68	Glider runway strip standards .....	85
<b>CHAPTER 7</b>	<b>OBSTACLE RESTRICTION AND LIMITATION.....</b>	<b>86</b>
<i>Division 1 General .....</i>		<i>86</i>
7.01	Introduction .....	86
7.02	Obstacle restriction area .....	86
<i>Division 2 Obstacle limitation surfaces (OLS).....</i>		<i>87</i>
7.03	Introduction .....	87
7.04	Reference elevation datum .....	87
7.05	Outer horizontal surface of the OLS.....	87
7.06	Conical surface .....	87
7.07	Inner horizontal surface .....	88
7.08	Approach surface .....	89
7.09	Transitional surface .....	90
7.10	Inner approach surface.....	91
7.11	Inner transitional surface .....	91
7.12	Baulked landing surface .....	92
7.13	Obstacle-free zone .....	93
7.14	Take-off climb surface.....	93
7.15	Approach runways — physical dimensions of the OLS .....	93
7.16	Take-off runways — physical dimensions of the take-off climb surface.....	96
7.17	Establishment of the OLS.....	96
7.18	Procedures for aerodrome operators to deal with obstacles in the OLS.....	97
7.19	Objects or structures that could become obstacles in the OLS.....	97
7.20	Monitoring of obstacles associated with instrument runways.....	98
<i>Division 3 Aerodrome obstacle and terrain charts .....</i>		<i>99</i>
7.21	Type A charts .....	99
7.22	Type B charts.....	100
7.23	Precision Approach Terrain Charts — ICAO.....	100
7.24	Aerodrome Terrain and Obstacle Charts — ICAO (Electronic) .....	100
<i>Division 4 Principles of shielding .....</i>		<i>101</i>
7.25	General .....	101
<b>CHAPTER 8</b>	<b>VISUAL AIDS PROVIDED BY AERODROME MARKINGS, MARKERS, SIGNALS, SIGNS, WIND DIRECTION INDICATORS ETC.....</b>	<b>102</b>
<i>Division 1 General .....</i>		<i>102</i>
8.01	General .....	102

8.02	Permanent aerodrome or partial movement area closure .....	102
8.03	Colours .....	102
8.04	Visibility of markings and markers .....	103
8.05	Dimensions and tolerances of markings .....	103
<i>Division 2 Markers .....</i>		<i>104</i>
8.06	Introduction .....	104
8.07	Cones .....	104
8.08	Works limit markers .....	105
8.09	Gable markers .....	106
8.10	Flush runway strip markers .....	106
8.11	The use of markers on a runway strip .....	106
8.12	The use of markers on an unsealed runway .....	108
8.13	The use of markers on an unsealed taxiway .....	109
8.14	The use of markers on an unsealed apron .....	109
<i>Division 3 Runway markings .....</i>		<i>110</i>
8.15	Introduction .....	110
8.16	Pre-threshold area markings .....	110
8.17	Runway threshold markings .....	111
8.18	Runway designation markings .....	113
8.19	Runway centreline markings .....	115
8.20	Runway end markings .....	116
8.21	Runway side-stripe markings .....	117
8.22	Aiming point markings .....	118
8.23	Touchdown zone markings .....	119
8.24	Touchdown zone markings – ICAO “A” – basic pattern .....	120
8.25	Touchdown zone markings — simple touchdown pattern .....	122
8.26	Permanently displaced threshold markings .....	123
8.27	Temporarily displaced threshold markings .....	124
8.28	Temporarily displaced threshold markings — more than 30 days .....	125
8.29	Temporarily displaced threshold markings — more than 5 days to 30 days or less .....	126
8.30	Temporarily displaced threshold markings — 5 days or less .....	127
8.31	Temporarily displaced threshold markings — large displacements for 30 days or less .....	128
8.32	Runway land and hold short position markings .....	131
8.33	Runway turn pad markings .....	131
8.34	Runway starter extension markings .....	132
<i>Division 4 Taxiway markings .....</i>		<i>133</i>
8.35	Introduction .....	133
8.36	Taxi guideline markings .....	133
8.37	Taxi guidelines on runways .....	133
8.38	Enhanced taxi guidelines .....	134
8.39	Runway holding position markings .....	135
8.40	Mandatory instruction markings .....	137
8.41	Information markings .....	138
8.42	Intermediate holding position markings .....	139
8.43	Taxiway edge markings .....	140
8.44	Holding bay markings .....	140
8.45	Taxiway limit markings .....	141
<i>Division 5 Apron markings .....</i>		<i>143</i>
8.46	Introduction .....	143

8.47	Apron taxi guidelines .....	143
8.48	Apron edge markings .....	143
8.49	Aircraft type designator markings .....	144
8.50	Parking clearance line.....	145
8.51	Aircraft apron limit line markings .....	146
8.52	Equipment clearance (staging) line markings .....	147
8.53	Equipment storage markings .....	147
8.54	Vehicle service road markings .....	148
8.55	Aircraft parking position markings .....	152
8.56	Lead-in lines .....	153
8.57	Aircraft parking position designation markings — apron taxiway and taxilane.....	153
8.58	Aircraft parking position designations — parking position .....	154
8.59	Aircraft type parking restriction designator markings.....	156
8.60	Aircraft parking position limit designators.....	157
8.61	Pilot turn line markings .....	158
8.62	Primary aircraft parking position markings.....	159
8.63	Marshaller stop lines.....	160
8.64	Pilot stop line markings .....	160
8.65	Alignment lines .....	161
8.66	Secondary aircraft parking position markings.....	162
8.67	Keyhole markings.....	163
8.68	Lead-out lines .....	163
8.69	Designation characters for taxi and apron markings .....	164
8.70	Push-back operator guidance markings.....	169
8.71	Aircraft push-back lines .....	170
8.72	Tug push-back vehicle parking position line markings.....	170
8.73	Towbar disconnect markings.....	171
8.74	Push-back limit markings .....	172
8.75	Push-back alignment bar markings .....	172
8.76	Passenger path markings .....	173
8.77	Miscellaneous area line markings.....	174
8.78	Hazardous area markings.....	174
<i>Division 6 Movement area guidance signs (MAGS) .....</i>		<i>175</i>
8.79	Introduction .....	175
8.80	Naming of taxiway location signs .....	175
8.81	Dimensions and location .....	176
8.82	Sign size and location distances, including runway exit signs .....	176
8.83	The face width of a sign .....	184
8.84	Structural .....	185
8.85	Illumination .....	185
8.86	MAGS with mandatory instructions.....	186
8.87	Runway designation signs .....	186
8.88	CAT I, II or III runway designation signs .....	187
8.89	Runway holding position signs .....	187
8.90	Aircraft NO ENTRY signs .....	188
8.91	Vehicle STOP signs.....	188
8.92	Runway/runway intersection signs.....	189
8.93	MAGS with information.....	189
8.94	Taxiway location signs .....	189
8.95	Taxiway direction signs.....	190



8.96	Destination signs .....	190
8.97	Take-off run available signs .....	191
8.98	Runway exit signs.....	192
8.99	LAHSO distance-to-go signs.....	192
8.100	Parking position identification signs .....	193
<i>Division 7 Wind direction indicators .....</i>		<i>194</i>
8.101	Requirements.....	194
8.102	Standards for wind direction indicators.....	195
<i>Division 8 Ground signals.....</i>		<i>197</i>
8.103	Signal areas.....	197
8.104	Ground signals in signal areas.....	197
<i>Division 9 Markings for unserviceable areas and works areas .....</i>		<i>200</i>
8.105	Introduction .....	200
8.106	Markings for unserviceable runways, taxiways and other movement areas .....	200
8.107	When unserviceability markings are not required.....	202
8.108	Use of unserviceability markers .....	203
<i>Division 10 Obstacle markings .....</i>		<i>205</i>
8.109	Obstacles and hazardous obstacles.....	205
8.110	Marking of hazardous obstacles .....	205
8.111	Marking of hazardous transient obstacles .....	208
<i>Division 11 Frangibility of markers and signs.....</i>		<i>209</i>
8.112	Markers.....	209
8.113	Movement area guidance signs .....	209
<i>Division 12 Helicopter areas on aerodromes .....</i>		<i>211</i>
8.114	Introduction .....	211
8.115	Helicopter touchdown and lift-off area markings — non-runway type FATO area .....	211
8.116	Helicopter touchdown and lift-off area markings — runway type FATO area.....	212
8.117	FATO area perimeter markings — non-runway type.....	214
8.118	FATO area perimeter markings — runway type .....	215
8.119	Helicopter taxiway markings.....	216
8.120	Helicopter apron markings .....	216
8.121	Helicopter taxi guideline designations .....	216
8.122	Helicopter parking position designation markings.....	217
8.123	Helicopter parking position markings — shoulder-line type .....	217
8.124	Helicopter parking position markings — touchdown/positioning circle type.....	219
8.125	Helicopter apron edge markings.....	221
<i>Division 13 Marking of glider runway strips on an aerodrome.....</i>		<i>223</i>
8.126	General .....	223
<b>CHAPTER 9 VISUAL AIDS PROVIDED BY AERODROME LIGHTING .....</b>		<b>225</b>
<i>Division 1 Lighting requirements.....</i>		<i>225</i>
9.01	Minimum lighting system requirements.....	225
9.02	Electrical circuitry .....	225
9.03	Primary electrical power supply .....	226
9.04	Secondary electrical power supply .....	226
9.05	Switch-over time for secondary power supply .....	227
9.06	Stand-by power supply .....	228
9.07	Portable runway lights.....	228

9.08	Portable lights on taxiways and apron edges.....	229
9.09	Light fixtures and supporting structures.....	230
9.10	Standardisation of aerodrome lighting.....	230
9.11	Elevated and inset lights.....	231
9.12	Lighting intensity and control.....	232
9.13	Colours for aeronautical ground lights.....	234
9.14	Chromaticity for incandescent lights.....	234
9.15	Chromaticity for solid state (LED) lights.....	236
9.16	Discrimination between incandescent coloured lights.....	239
<i>Division 2 Commissioning.....</i>		<i>240</i>
9.17	Commissioning of lighting systems — ground checks.....	240
9.18	Commissioning of lighting systems — flight checks.....	241
<i>Division 3 Pilot-activated lighting systems.....</i>		<i>243</i>
9.19	General.....	243
9.20	VHF carrier activation code.....	244
9.21	VHF carrier receiver technical requirements.....	244
9.22	Inputs to the PAL.....	245
9.23	Fail-safe arrangements with the PAL.....	245
9.24	Access to manual switches.....	245
9.25	Receiving antenna.....	245
9.26	PAL with audio acknowledgment.....	246
<i>Division 4 Obstacle lighting.....</i>		<i>247</i>
9.27	Artificial objects and structures.....	247
9.28	Natural obstacles.....	248
9.29	Temporary artificial obstacles.....	248
9.30	Types of obstacle lighting and their use.....	248
9.31	Location of obstacle lights.....	249
9.32	Characteristics of low-intensity obstacle lights.....	253
9.33	Characteristics of medium-intensity obstacle lights.....	254
9.34	Characteristics of high-intensity obstacle lights.....	254
9.35	Floodlighting of hazardous obstacles.....	255
9.36	Serviceability of obstacle lights.....	256
<i>Division 5 Aerodrome lighting systems.....</i>		<i>258</i>
9.37	Aerodrome beacons.....	258
9.38	Illuminated wind direction indicators.....	258
<i>Division 6 Simple approach lighting.....</i>		<i>260</i>
9.39	Simple approach lighting system.....	260
9.40	Simple approach lighting system — additional requirements.....	262
<i>Division 7 Precision approach CAT I, II and III lighting systems.....</i>		<i>264</i>
9.41	Precision approach CAT I lighting system.....	264
9.42	Precision approach CAT II and CAT III lighting system.....	267
<i>Division 8 Isocandela diagrams of approach lighting.....</i>		<i>271</i>
9.43	Isocandela diagrams of approach lighting.....	271
<i>Division 9 Visual approach slope indicator systems.....</i>		<i>274</i>
9.44	Visual approach slope indicator systems (VASISs).....	274
9.45	Obstacle assessment surfaces.....	274
9.46	T-VASIS and AT-VASIS.....	276

9.47	Characteristics of T-VASIS light units.....	277
9.48	Precision approach path indicator system ( <i>PAPI</i> ).....	280
9.49	Approach slope and elevation setting of light units .....	281
9.50	Siting a <i>PAPI</i> or a double-sided <i>PAPI</i> .....	283
<i>Division 10 Runway lights</i> .....		287
9.51	Runway edge lights .....	287
9.52	Characteristics of runway edge lights — non-instrument or non-precision approach runway .....	288
9.53	Characteristics of runway edge lights — precision approach runway .....	289
9.54	Runway threshold lights.....	289
9.55	Pattern of runway threshold lights — non-instrument or non-precision approach runway .....	290
9.56	Pattern of runway threshold lights — precision approach runway .....	290
9.57	Characteristics of runway threshold lights — non-instrument or non-precision approach runway .....	290
9.58	Characteristics of runway threshold lights — precision approach runway .....	290
9.59	Additional lighting to enhance threshold location — threshold wing bars and runway threshold identification lights .....	291
9.60	Temporarily displaced threshold lights for use at night .....	292
9.61	Location of temporarily displaced threshold lights .....	292
9.62	Characteristics of temporarily displaced threshold lights.....	292
9.63	Runway lighting before a displaced threshold .....	293
9.64	Runway end lights .....	293
9.65	Characteristics of non-instrument and non-precision approach runway end lights.....	294
9.66	Characteristics of precision approach runway end lights .....	295
9.67	Runway turn pad, runway bypass pad and runway starter extension edge lights .....	295
9.68	Stopway lights .....	296
9.69	Hold short lights .....	296
9.70	Runway centreline lights .....	297
9.71	Simple touchdown zone ( <i>TDZ</i> ) lights.....	298
9.72	Runway <i>TDZ</i> lights .....	299
9.73	Photometric characteristics of runway lights and calculation method .....	299
9.74	Installation and aiming of light fittings .....	299
9.75	Isocandela diagrams of runway lighting.....	300
9.76	Illustrations of runway lighting .....	312
<i>Division 11 Taxiway lights</i> .....		318
9.77	Provision of taxiway centreline lights .....	318
9.78	Provision of taxiway edge lights .....	318
9.79	Taxiway markers .....	319
9.80	Apron taxiway lighting.....	319
9.81	Use of different types of taxiway lights .....	319
9.82	Control of lights on taxiways .....	320
9.83	Location of taxiway centreline lights .....	320
9.84	Spacing of taxiway centreline lights.....	320
9.85	Location of taxiway centreline lights on entry and exit taxiways .....	321
9.86	Location of taxiway centreline lights on exit taxiways other than rapid exit taxiways.....	322
9.87	Location of taxiway centreline lights on rapid exit taxiways.....	322
9.88	Characteristics of taxiway centreline lights.....	322
9.89	Rapid exit taxiway indicator lights.....	323
9.90	Beam dimensions and light distribution of taxiway centreline lights .....	324

9.91	Location of taxiway edge lights .....	324
9.92	Spacing of taxiway edge lights.....	325
9.93	Characteristics of taxiway edge lights.....	326
9.94	Taxiway edge markers.....	327
9.95	Characteristics of taxiway edge markers.....	327
9.96	Taxiway centreline markers.....	327
9.97	Characteristics of taxiway centreline markers.....	327
9.98	Provision of runway guard lights .....	327
9.99	Pattern and location of runway guard lights.....	328
9.100	Characteristics of runway guard lights .....	328
9.101	Control of runway guard lights.....	329
9.102	Provision of intermediate holding position lights .....	329
9.103	Pattern and location of intermediate holding position lights.....	329
9.104	Characteristics of intermediate holding position lights .....	330
9.105	Stop bars .....	330
9.106	Location of stop bars .....	331
9.107	Characteristics of stop bar lights .....	331
9.108	No entry bars .....	332
9.109	Photometric characteristics of taxiway lights.....	332
9.110	Installation and aiming of light fittings .....	332
9.111	Isocandela diagrams for taxiway lights .....	333
9.112	Illustrations of taxiway lighting.....	338
<i>Division 12 Apron lights.....</i>		<i>341</i>
9.113	Apron floodlighting.....	341
9.114	Provision of apron floodlighting .....	341
9.115	Location of apron floodlighting.....	341
9.116	Characteristics of apron floodlighting.....	342
<i>Division 13 Aircraft parking position lighting.....</i>		<i>345</i>
9.117	Visual docking guidance systems.....	345
9.118	Characteristics of visual docking guidance systems.....	345
9.119	Azimuth guidance unit — location.....	346
9.120	Azimuth guidance unit — characteristics.....	346
9.121	Stopping position indicator — location.....	346
9.122	Stopping position indicator — characteristics.....	346
9.123	Advanced visual docking guidance system (A-VDGS) .....	346
9.124	Characteristics of an A-VDGS .....	347
9.125	Aircraft parking position manoeuvring guidance lights.....	349
9.126	Parking position identification signage .....	349
<i>Division 14 Works and unserviceable area lighting.....</i>		<i>350</i>
9.127	Lighting associated with closed and unserviceable areas.....	350
9.128	Lighted visual aid to indicate a temporary complete runway closure .....	350
9.129	Characteristics of a lighted visual aid to indicate a temporary complete runway closure....	351
9.130	Isocandela diagram for lighted visual aid to indicate temporary runway closure .....	352
9.131	Movement area access in the vicinity of unserviceable areas .....	353
9.132	Characteristics of unserviceability lights.....	354
<i>Division 15 Other lights on an aerodrome.....</i>		<i>355</i>
9.133	Works limit lights .....	355
9.134	Road and car park lighting .....	355
9.135	Road-holding position light.....	355

<i>Division 16</i>	<i>Monitoring, maintenance and serviceability of aerodrome lighting</i> .....	356
9.136	General .....	356
9.137	Reporting of aerodrome lighting outage.....	356
9.138	Standards for apron lighting unserviceability.....	358
9.139	T-VASIS standards for unserviceability .....	358
9.140	PAPI unserviceability standards.....	359
9.141	Interleaved circuitry.....	359
9.142	Movement area guidance signs .....	360
9.143	Other lighting on the aerodrome.....	360
9.144	Lights — requirements for zones .....	361
<b>CHAPTER 10</b>	<b>AERODROME MANUAL.....</b>	<b>363</b>
10.01	Requirement for an aerodrome manual .....	363
10.02	Form, contents and updating of the aerodrome manual .....	363
10.03	Version control and changes to an aerodrome manual.....	364
10.04	Application or adoption of other material by the aerodrome manual.....	364
<b>CHAPTER 11</b>	<b>INFORMATION THAT MUST BE INCLUDED IN THE AERODROME MANUAL.....</b>	<b>365</b>
11.01	Aerodrome information .....	365
11.02	Aerodrome administration.....	365
11.03	Aerodrome serviceability inspections .....	366
11.04	Aerodrome lighting .....	366
11.05	Aerodrome reporting .....	367
11.06	Obstacle control.....	367
11.07	Aerodrome works safety.....	368
11.08	Wildlife hazard management.....	369
11.09	Aerodrome safety management.....	369
11.10	Aerodrome technical inspections.....	369
11.11	Unauthorised entry to aerodrome .....	370
11.12	Aerodrome emergency response .....	370
11.13	Disabled aircraft removal .....	371
11.14	Airside vehicle control .....	372
11.15	Aircraft parking control.....	372
11.16	Protection of communication, navigation, surveillance and meteorological facilities.....	372
11.17	All-weather operations .....	373
<b>CHAPTER 12</b>	<b>INSPECTING AND REPORTING AERODROME CONDITION AND COMPLIANCE .....</b>	<b>374</b>
<i>Division 1</i>	<i>Serviceability inspections.....</i>	<i>374</i>
12.01	General .....	374
12.02	Timing of inspections .....	375
12.03	Serviceability inspection requirements.....	375
12.04	Reporting reportable occurrences.....	378
12.04A	Global reporting format and aerodrome serviceability inspection requirements.....	379
<i>Division 2</i>	<i>Aerodrome technical inspection programs.....</i>	<i>383</i>
12.05	Content of aerodrome technical inspection programs .....	383
12.06	Inspections at higher volume movement aerodromes .....	383
12.07	Inspections at lower volume movement aerodromes .....	383
12.08	Other requirements for aerodrome technical inspection programs .....	384

12.09	Inspection requirements.....	386
12.10	Conduct of aerodrome technical inspections.....	387
12.11	Annual aerodrome manual validation and report .....	388
<b>CHAPTER 13</b>	<b>AERODROME PERSONNEL FUNCTIONS.....</b>	<b>391</b>
13.01	Introduction .....	391
13.02	Accountable manager .....	391
13.03	Reporting officer .....	391
13.04	Works safety officer .....	392
<b>CHAPTER 14</b>	<b>CONTROL OF AIRSIDE ACCESS AND VEHICLE CONTROL.....</b>	<b>394</b>
14.01	Airside access and operation of vehicles — training .....	394
14.02	Airside access permits .....	394
14.03	Airside vehicle requirements .....	394
14.04	Surveillance equipment installed on an airside vehicle.....	396
14.05	Airside vehicle lighting requirements .....	396
14.06	Surface vehicle control and communications.....	397
<b>CHAPTER 15</b>	<b>AERODROME WORKS .....</b>	<b>398</b>
15.01	General .....	398
15.02	Method of working plans ( <i>MOWPs</i> ) .....	399
15.03	Time-limited works .....	400
15.04	Management and control of aerodrome works .....	401
15.05	Runway pavement overlay, reconstruction, resealing or widening works.....	401
15.06	Works on runway strips.....	402
<b>CHAPTER 16</b>	<b>METHOD OF WORKING PLANS.....</b>	<b>403</b>
16.01	Introduction .....	403
16.02	Works information.....	403
16.03	Restrictions to aircraft operations.....	404
16.04	Personnel and equipment.....	404
16.05	Aerodrome markers, markings and lights .....	405
16.06	Special requirements .....	405
16.07	Administration .....	405
16.08	Authority.....	405
16.09	Drawings.....	405
16.10	Distribution list.....	406
<b>CHAPTER 17</b>	<b>WILDLIFE HAZARD MANAGEMENT .....</b>	<b>407</b>
17.01	Detection, monitoring and observation .....	407
17.02	Wildlife hazard assessment and trigger criteria.....	407
17.03	Wildlife hazard management plan triggers.....	407
17.04	Preparation of a wildlife hazard management plan .....	408
17.05	Wildlife hazard reporting.....	409
17.06	Wildlife hazard mitigation.....	410
17.07	Training .....	410
<b>CHAPTER 18</b>	<b>PAVEMENT MAINTENANCE.....</b>	<b>411</b>
18.01	Pavement cleanliness.....	411
18.02	Runway surface friction or texture .....	411
18.03	Water pooling or ponding.....	411

<b>CHAPTER 19</b>	<b>COMMUNICATION, NAVIGATION, SURVEILLANCE (CNS) AND METEOROLOGICAL (MET) FACILITIES.....</b>	<b>412</b>
<i>Division 1</i>	<i>General .....</i>	<i>412</i>
19.01	General .....	412
19.02	Maintenance .....	413
19.03	Installation requirements .....	413
<i>Division 2</i>	<i>CNS facilities .....</i>	<i>414</i>
19.04	Protection of VOR facilities .....	414
19.05	Protection of DME facilities.....	414
19.06	Protection of instrument landing systems (ILS) .....	415
19.07	Protection of marker beacons .....	416
19.08	Protection of non-directional beacons (NDBs).....	416
19.09	Protection of ground-based augmented systems (GBASs) .....	416
19.10	Protection of radar sensor sites.....	417
19.11	Protection of wide area multilateration (WAM) and automatic dependent surveillance – broadcast (ADS-B) sensors .....	418
19.12	Protection of VHF/UHF communication facilities.....	418
19.13	Protection of HF communication facilities.....	419
19.14	Protection of satellite ground stations (SGSs) .....	420
19.15	Protection of microwave links.....	421
19.16	Siting requirements for CNS facilities .....	422
<i>Division 3</i>	<i>Meteorological facilities .....</i>	<i>424</i>
19.17	Protection of meteorological facilities.....	424
19.18	Siting requirements for meteorological facilities .....	424
<b>CHAPTER 20</b>	<b>EARTHING POINTS.....</b>	<b>426</b>
20.01	Ground earthing points.....	426
<b>CHAPTER 21</b>	<b>LIGHT AIRCRAFT TIE-DOWN FACILITIES.....</b>	<b>427</b>
21.01	Tie-down facilities.....	427
<b>CHAPTER 22</b>	<b>RADIO COMMUNICATION FACILITIES.....</b>	<b>428</b>
22.01	Certified air/ground radio service (CA/GRS).....	428
22.02	Aerodrome frequency confirmation system (AFCS).....	429
22.03	Operation of UNICOM or CA/GRS.....	430
22.04	Aerodrome frequency response unit.....	430
22.05	Power supply and changeover indications .....	431
22.06	UNICOM services .....	431
<b>CHAPTER 23</b>	<b>LOW-VISIBILITY OPERATIONS.....</b>	<b>433</b>
23.01	Introduction .....	433
23.02	Development of low-visibility procedures (LVP) .....	433
23.03	Implementation of low-visibility procedures .....	434
23.04	Review of low-visibility procedures .....	434
23.05	Runway visual range equipment .....	435
23.06	Standards for runways supporting certain precision approach operations .....	435
23.07	Facilities and procedures for conducting runway visibility assessments .....	436
23.08	Appointed persons conducting runway visibility assessments.....	437
23.09	Conducting runway visibility assessments .....	437

<b>CHAPTER 24</b>	<b>AERODROME EMERGENCY PLANNING AND RESPONSE</b>	<b>439</b>
24.01	Emergency committee	439
24.02	Aerodrome emergency plan	439
24.03	Other emergency response arrangements	441
24.04	Aerodrome location details or maps for emergency agencies	441
24.05	Emergency preparedness — operators to whom section 24.02 applies	442
24.06	Emergency preparedness — operators to whom section 24.02 does not apply	443
<b>CHAPTER 25</b>	<b>SAFETY MANAGEMENT SYSTEMS</b>	<b>444</b>
25.01	Introduction	444
25.02	Requirement for an SMS	444
25.03	Matters which must be addressed in an SMS	445
25.04	Particular SMS matters for aerodromes with scheduled international air transport operations	446
<b>CHAPTER 26</b>	<b>RISK MANAGEMENT PLANS</b>	<b>450</b>
26.01	Introduction	450
<b>NOTES TO PART 139 (AERODROMES) MANUAL OF STANDARDS 2019</b>		<b>452</b>



## CHAPTER 1 PRELIMINARY

### Division 1 General

#### 1.01 Name

- (1) This instrument is the *Part 139 (Aerodromes) Manual of Standards 2019*.
- (2) This instrument may also be cited as the Part 139 MOS.
- (3) In this instrument, unless the contrary intention appears, references to “the MOS” or “this MOS” are references to the Part 139 MOS.

#### 1.02 Commencement

This MOS commences immediately after the commencement of the *Civil Aviation Safety Amendment (Part 139) Regulations 2019*.

*Note* New Subparts 139.A to 139.F of CASR are contained in the *Civil Aviation Safety Amendment (Part 139) Regulations 2019*.

#### 1.03 Purpose

This MOS sets out:

- (a) the standards for certified aerodromes; and
- (b) in Chapter 22 only — certain standards for all aerodromes.

#### 1.04 Application

This MOS applies only in accordance with Chapter 2.

*Note 1* The standards in this MOS are the compliance requirements that must be met for the certification of an aerodrome as a certified aerodrome, or for the continued certification of an aerodrome after an upgrade or replacement of an existing aerodrome facility. When developing new aerodromes, or upgrading or replacing existing facilities, aerodrome operators should consider the aircraft types and operations to be accommodated by the facilities in order to apply the appropriate design, operating and reporting standards for the facility.

*Note 2* Without affecting the operation of Chapter 7, for objects or structures which CASA determines are hazardous under regulations 139.175 and 139.180 of CASR, CASA may recommend in writing to the person who owns, or is in occupation or control of, the object or structure that the standards in Chapter 8, Division 10 and Chapter 9, Division 4 should be observed.

#### 1.05 Conflict between this MOS and an incorporated document

Where a provision of this MOS is inconsistent with a provision of an incorporated document the MOS provision takes priority and the incorporated provision applies only insofar as it may do so consistently with the MOS provision.

#### 1.06 Tables, Figures and Notes

In this instrument:

- (a) if a numbered Figure, in the form of a drawing, diagram or similar representation, is expressed as *illustrating matters*, it is guidance that is to be taken into account in interpreting the provision which refers to the Figure; and
- (b) if a numbered Figure, in the form of a drawing, diagram or similar representation, is expressed as *showing matters*, it is to be read with, and may supplement, the information in the provision which refers to the Figure; and

- (c) a Note provides information and does not contain standards unless the contrary intention is expressed in a provision for the Note.

*Note* Tables and Figures are not numbered sequentially. For ease of reference, they are numbered by reference to the section or subsection which first refers to the Table or Figure.

## 1.07 References to ICAO and other documents

- (1) In this MOS, unless the contrary intention appears, a reference to an ICAO document (however described) is a reference to the document as in force or existing from time to time.
- (2) In this MOS, reference to a numbered ICAO Annex is a reference to the Annex of that number, as in force or existing from time to time, and as contained in the Chicago Convention.
- (3) In this MOS, reference to a numbered ICAO Manual is a reference to the Manual of that number, or subsequent version, as in force or existing from time to time and issued by ICAO.
- (4) In this MOS, reference to a numbered ICAO Circular is a reference to the Circular of that number, or subsequent version, as in force or existing from time to time and issued by ICAO.
- (5) If a provision of this MOS refers to an ICAO document, then, unless the contrary intention appears, the document, as in force or existing from time to time, is taken to be applied, adopted or incorporated for this MOS.

*Note 1* Relevant ICAO documents for this MOS may be accessed by navigating from the following link:  
<http://www.icao.int/publications/Pages/default.aspx>.

*Note 2* A reference to an ICAO document, including an ICAO Annex, which only occurs in a Note to a provision does not have the effect that the document is taken to be applied, adopted or incorporated for this MOS, unless the contrary intention appears. Such references in Notes are to documents which may be used as guidance or background information.

- (6) In this section, a reference to any ICAO document is to be taken as a reference to the document as affected by any difference that Australia has filed with ICAO in relation to the document.

*Note* Details of differences that Australia has filed with ICAO are in Section 1.7 of the Aeronautical Information Publication, General, which may be accessed by navigating from the following link:  
<http://www.airservicesaustralia.com/aip/aip.asp>.

- (7) In this MOS, a reference to any Federal Aviation Administration (*FAA*) Advisory Circular is a reference to the document in the version as in force or existing from time to time.
- (8) In this MOS, a reference to any CASA Advisory Circular is a reference to the document in the version as in force or existing from time to time.
- (9) In this MOS, a reference to any legislative instrument is a reference to the instrument as in force or existing from time to time.

## 1.08 References to intended, nominated, preferred and “should” in a Note

- (1) In this instrument, unless the contrary intention appears, a reference (however formulated) to a matter or thing *intended* by an aerodrome operator to be for a purpose, is a reference to the operator’s intention as reasonably deduced or inferred from the following:
  - (a) the operator’s expressed intention (if any);

- (b) the nature and factual circumstances of the matter, whether or not any intention is expressed.
- (2) In this instrument, unless the contrary intention appears, a reference to a matter or a thing that is ***nominated*** means nominated by an aerodrome operator, and the nomination of the matter or thing must be recorded in the aerodrome manual.
- (3) In this instrument, unless the contrary intention appears, a reference (however formulated) in a provision or a Table to a matter, thing or value that is ***preferred*** means that, as far as practicable, the use of the matter, thing or value is required in priority to another matter, thing or value expressed in the provision or Table, or in a related provision or Table, although the other matter, thing or value expressed must be used or observed if the preferred matter, thing or value is not used because it is impracticable to do so.

*Note* The preferred outcome is mandated, but if it is impracticable, the prescribed lesser option must still be complied with.

- (4) For subsection (3), if the preferred matter, thing or value is not complied with, the aerodrome manual must contain:
  - (a) a statement to that effect; and
  - (b) the reasons for non-compliance; and
  - (c) the alternative matter, thing or value that is complied with.

*Note* See also paragraph 11.01 (3) (d).

- (5) In this instrument, unless the contrary intention appears:
  - (a) where a maximum value is mentioned for something — that value must not be exceeded; and
  - (b) where a minimum value is mentioned for something — at least that value must be achieved.
- (6) Unless the contrary intention appears, if a Note at the end of a provision states that some matter “should” be the case, the Note is to be read as a CASA recommendation but without affecting the meaning of the relevant provision.

*Note* CASA recommendations are usually expressly identified as such. Other uses of the word “should” in a Note are usually for the purpose of assisting readers to understand the meaning of the related provision.

## **1.09 Table of Contents**

The Table of Contents at the front of this MOS is not part of this instrument. It is for guidance only and may be modified or edited in any published version of this instrument.

## CHAPTER 1 PRELIMINARY

### Division 2 Empowerments

#### 1.10 General power to make a Part 139 Manual of Standards

This MOS and all of its provisions are made under the powers conferred on CASA by regulation 139.005 of CASR.

#### 1.11 Specific regulations for which MOS provisions have been made

##### Aerodrome manuals

- (1) The requirements in this MOS relating to aerodrome manuals for an aerodrome are made for regulation 139.045 of CASR.

*Note* See, in particular, Chapters 5, 6, 7, 8, 9, 10, 11, 12, 14, 17 and 23.

##### Aerodrome facilities etc.

- (2) The requirements in this MOS relating to aerodrome facilities and equipment for certified aerodromes are made for regulation 139.065 of CASR.

*Note* See, in particular, Chapters 4, 6, 8, 9, 14, 18, 19, 20, 21 and 22.

##### Planning etc.

- (3) The requirements in this MOS relating to planning aerodrome works, giving notice of planned aerodrome works, and carrying out aerodrome works, at a certified aerodrome are made for regulation 139.070 of CASR.

*Note* See, in particular, Chapters 8, 9, 11, 13, 15 and 16.

##### Inspections

- (4) The requirements in this MOS relating to aerodrome inspections are made for regulation 139.075 of CASR.

*Note* See, in particular, Chapters 11 and 12.

##### Reporting to AIS provider

- (5) The requirements in this MOS relating to the operator of a certified aerodrome reporting information to an AIS provider are made for regulation 139.080 of CASR.

*Note* See, in particular, Chapters 5, 11 and 17.

##### Reporting changes etc.

- (6) The requirements in this MOS relating to reporting changes or occurrences at certified aerodromes are made for regulation 139.085 of CASR.

*Note* See, in particular, Chapters 5, 6, 7, 8, 9, 12, 15, 17, 19.

##### Monitoring airspace etc.

- (7) The requirements in this MOS relating to the following:
  - (a) monitoring the airspace around a certified aerodrome for infringements, or potential infringements, of the airspace;
  - (b) reporting such infringements, or potential infringements;

(c) reporting changes or occurrences at certified aerodromes;  
are made for regulation 139.090 of CASR.

*Note* See, in particular, Chapters 7 and 12.

### Safety management systems and risk management plans

- (8) The requirements in this MOS relating to the following:
- (a) the circumstances in which a certified aerodrome must have a safety management system (**SMS**);
  - (b) safety management systems for aerodromes;
  - (c) the circumstances in which a certified aerodrome must have a risk management plan;
  - (d) risk management plans for aerodromes;
- are made for regulation 139.095 of CASR.

*Note* See, in particular, Chapters 25 and 26.

### Emergency preparedness etc.

- (9) The requirements in this MOS relating to the following:
- (a) emergency preparedness of aerodromes;
  - (b) the circumstances in which a certified aerodrome must have an aerodrome emergency plan;
  - (c) aerodrome emergency plans for aerodromes;
- are made for regulation 139.100 of CASR.

*Note* See, in particular, Chapters 11 and 24.

### Other aerodrome systems

- (10) The requirements in this MOS relating to the following:
- (a) the kind of systems (other than an SMS) that an aerodrome must have;
- Note* Systems include the following:
- (a) wildlife hazard management systems;
  - (b) airside vehicle control systems;
  - (c) aircraft parking control systems.
- (b) the circumstances in which a certified aerodrome must have a relevant system;
  - (c) the relevant system;
- are made for regulation 139.105 of CASR.

*Note* See, in particular, Chapters 11, 14, 17.

### Aerodrome personnel

- (11) The requirements in this MOS relating to additional personnel that an operator of a certified aerodrome must have are made for regulation 139.110 of CASR.

### Training aerodrome personnel

- (12) The requirements in this MOS relating to the training, knowledge, qualifications and experience of personnel carrying out the responsibilities of the following positions:
- (a) accountable manager;
  - (b) reporting officer;
  - (c) if aerodrome works are being carried out at the aerodrome—works safety officer;
  - (d) any other position to which subsection (11) applies;
- are made for regulation 139.115 of CASR.

*Note* See, in particular, Chapters 13, 17 and 23.

### Personnel responsibilities

- (13) The requirements in this MOS relating to the personnel mentioned in subsection (12) carrying out the responsibilities of their positions are made for regulation 139.120 of CASR.

*Note* See, in particular, Chapters 13, 17 and 23.

### Ground surveillance systems

- (14) The requirements in this MOS relating to the following:
- (a) aerodrome ground surveillance systems;
  - (b) surveillance equipment installed on an airside vehicle;
  - (c) airside vehicle control in conjunction with ground surveillance systems;
- are made for regulation 139.130 of CASR.

*Note* See, in particular, Chapters 14 and 23.

### Aircraft movement data from aerodrome operators

- (15) The requirements in this MOS relating to the kinds of aircraft movement data that an aerodrome operator must give to CASA upon request are made for regulation 139.140 of CASR.

*Note* See, in particular, relevant definitions in Chapter 3.

### Aircraft movement data from ATS provider

- (16) The requirements in this MOS relating to the kinds of aircraft movement data that an air traffic service (ATS) provider must give to CASA upon request are made for regulation 139.145 of CASR.

*Note* See, in particular, relevant definitions in Chapter 3.

### Frequency confirmation systems

- (17) The requirements in this MOS relating to the following:
- (a) the circumstances in which a certified aerodrome must have a frequency confirmation system for the aerodrome;
  - (b) frequency confirmation systems for aerodromes;
- are made for regulation 139.150 of CASR.

*Note* See, in particular, Chapter 22.

## CA/GRS

- (18) The requirements in this MOS relating to the operation of a certified air/ground radio service (CA/GRS) are made for regulation 139.160 of CASR.

*Note* See also regulation 139.155 of CASR and Chapter 22 of this MOS.

### Proposals to construct structures etc.

- (19) The requirements in this MOS relating to any person's proposal for the construction and erection of additional objects and structures are made for regulation 139.165 of CASR.

*Note* See, in particular, Chapter 7.

### Information for CASA about proposed construction etc.

- (20) The requirements in this MOS relating to other information to be given to CASA in relation to a person's proposal for the construction and erection of objects and structures that:

- (a) will have a height of 100 metres or more above ground level; or
- (b) will include an emissions source that generates a gaseous efflux with a velocity exceeding 4.3 metres per second at the point of emission; or
- (c) are of a kind mentioned in subsection (19);

are made for regulation 139.165 of CASR.

*Note* See, in particular, Chapter 7.

### Proposals to create an emissions source

- (21) The requirements in this MOS relating to any person's proposal for other activities to be undertaken that will create an emissions source are made for regulation 139.170 of CASR.

### Information for CASA about proposed emissions sources

- (22) The requirements in this MOS relating to other information to be given to CASA in relation to a person's proposal:

- (a) to generate a gaseous efflux with a velocity exceeding 4.3 metres per second at the point of emission; or
- (b) of a kind mentioned in subsection (21);

are made for regulation 139.170 of CASR.

### What constitutes a hazard

- (23) For regulations 139.175, 139.180 and 139.185 of CASR, this MOS prescribes the kinds of objects, structures, and emissions sources, that constitute a hazard to aircraft operations.

*Note* See, in particular, Chapter 7.

### Obstacle limitation surface

- (24) The requirements in this MOS for ascertaining a surface associated with an aerodrome are prescribed for the definition of *obstacle limitation surface* in the CASR Dictionary.

*Note* See, in particular, Chapter 7.

## **CHAPTER 1A      TRANSITIONAL PROVISIONS**

### **Division 1    General**

#### **1A.01 Application**

In this Chapter:

- (a) Divisions 2 to 6, and Division 8 apply to an aerodrome that immediately before 13 August 2020 was a registered aerodrome to which a provision of this MOS applies on and after 13 August 2020 as a consequence of the operation of regulations 202.701 and 202.702 of CASR; and
- (b) Division 7 applies to an aerodrome that immediately before 13 August 2020 was a certified aerodrome that has scheduled international air transport operations, to which a provision of this MOS applies on and after 13 August 2020 as a consequence of the operation of regulations 202.701 and 202.702 of CASR.

### **Division 2    Technical inspection programs**

#### **1A.02 Technical inspection programs**

- (1) This section applies despite subsections 12.06 (2) and 12.07 (2).
- (2) For the first application of subsection 12.06 (1) or 12.07 (1) to an aerodrome, “financial year” is taken to be the financial year commencing on 1 July 2020.
- (3) Subject to subsection (4), for the first application of subsection 12.06 (1) or 12.07 (1) to an aerodrome, all elements of the first aerodrome technical inspection must be implemented not later than 13 November 2022.
- (4) If, in the 12 months immediately before 13 August 2020, a safety inspection had been conducted for the aerodrome under regulation 139.315 of CASR (as in force immediately before 13 August 2020) then, for the first application of subsection 12.06 (1) or 12.07 (1) to the aerodrome, all elements of the first aerodrome technical inspection must be implemented not later than 13 November 2021.

### **Division 3    Annual aerodrome manual validation and report**

#### **1A.03 Annual aerodrome manual validation and report**

- (1) This section applies despite subsection 12.11 (2) and subparagraph 12.11 (11) (d) (i).
- (2) For the first application of subsection 12.11 (1) to an aerodrome, “financial year” is taken to be the financial year commencing on 1 July 2020.
- (3) Subject to subsection (4), for the first application of subsection 12.11 (1) to an aerodrome, the first aerodrome manual validation must be carried out not later than 12 months after CASA grants the aerodrome operator a new aerodrome certificate under paragraph 202.702 (7) (a).
- (4) The aerodrome operator must conduct a check of the currency and accuracy of aerodrome information published in the AIP, not later than the date on which the aerodrome operator would have been required to comply with subparagraph 12.11 (11) (d) (i) if subsection (3) had not been made.



## **Division 4 Wildlife hazard management plans**

### **1A.04 Wildlife hazard management plans**

- (1) This section applies despite subsection 17.03 (2).
- (2) For the first application of subsection 17.03 (1) to an aerodrome, “financial year” is taken to be the financial year commencing on 1 July 2020.
- (3) For the first application of subsection 17.03 (1) to an aerodrome, the first wildlife hazard management plan must be prepared and implemented not later than 13 November 2022.

## **Division 5 Aerodrome emergency plans**

### **1A.05 Aerodrome emergency plans**

- (1) This section applies:
  - (a) despite subsection 24.02 (2); and
  - (b) as if the reference in subsection 24.02 (1) to subsection 24 02 (2) were a reference to subsection (3) of this section.
- (2) For the first application of subsection 24.02 (1) to an aerodrome, “financial year” is taken to be the financial year commencing on 1 July 2020.
- (3) For the first application of subsection 24.02 (1) to an aerodrome:
  - (a) the aerodrome operator must have an aerodrome emergency plan for the aerodrome not later than 13 November 2022; and
  - (b) until 13 November 2022, section 24.05 does not apply to the aerodrome operator; and
  - (c) until 13 November 2022, section 24.06 applies to the aerodrome operator.

## **Division 6 Requirement for an SMS**

### **1A.06 Requirement for an SMS (registered aerodromes)**

- (1) This section applies despite subsection 25.02 (2).
- (2) For the first application of subsection 25.02 (1) to an aerodrome, “financial year” is taken to be the financial year commencing on 1 July 2020.
- (3) For the first application of subsection 25.02 (1) to an aerodrome, the first SMS must be prepared and implemented not later than 13 November 2022.

## **Division 7 Requirement for an SMS (certified aerodromes with scheduled international air transport operations)**

### **1A.07 Requirement for an SMS**

- (1) This section applies to the operator of an aerodrome that, immediately before 13 August 2020, had scheduled international air transport operations.
- (2) For the first application of paragraph 25.04 (1) (b) to the aerodrome, the first SMS that provides for, and includes documented details of, the matters mentioned in subsections 25.04 (2) to (16) must be prepared and implemented not later than 13 November 2021.

## **Division 8 Risk management plans**

### **1A.08 Risk management plans**

- (1) This section applies despite paragraphs 26.01 (1) (c) and (d).
- (2) For the first application of subsection 26.01 (1) to an aerodrome, “financial year” is taken to be the financial year commencing on 1 July 2020.
- (3) For the first application of subsection 26.01 (1) to an aerodrome, the aerodrome operator must have a risk management plan prepared and implemented not later than 13 November 2022.

## CHAPTER 2 APPLICATION OF STANDARDS

### 2.01 Definitions

In this Chapter:

**CASR** means the *Civil Aviation Safety Regulations 1998*.

**certified aerodrome** means an aerodrome that was a certified aerodrome under Part 139 of CASR immediately before the commencement of this MOS.

**existing aerodrome** means an aerodrome that was in service as a certified aerodrome or a registered aerodrome under the document called ‘Manual of Standards (MOS) – Part 139 Aerodromes’ as in force immediately before the commencement of this MOS.

**existing aerodrome facility** means a facility that would have fallen within the definition of an **aerodrome facility** immediately before the commencement of this MOS had the definition of **aerodrome facility** then been in force.

*Note* **Aerodrome facility** is defined in subsection 3.01 (2).

**grandfathered facility** means an existing aerodrome facility (the **facility**) and the obstacle limitation surfaces associated with an existing runway that is part of the existing aerodrome facility (the **OLS**) that, on and after the commencement of this MOS, do not comply with the standards in this MOS, provided that:

- (a) the facility and the OLS complies, and continues to comply, with the standards which applied to the facility and the OLS immediately before the commencement of this MOS; and

*Note* CASA guidance documents identify the range of previous standards that may have applied.

- (b) the aerodrome operator’s aerodrome manual:
  - (i) identifies the facility and the OLS; and
  - (ii) sets out in detail how the facility and the OLS do not comply with this MOS.

**opted-in** means that:

- (a) an aerodrome operator voluntarily tells CASA in writing that from a specified date after the commencement of this MOS, a specified grandfathered facility will comply with the requirements of this MOS for the facility; and
- (b) the aerodrome operator’s aerodrome manual specifies the date and the facility; and
- (c) CASA acknowledges, in writing, that the operator has opted-in.

**registered aerodrome** means an aerodrome that was a registered aerodrome under Part 139 of CASR immediately before the commencement of this MOS.

**replacement**, for an existing aerodrome facility, means completion of any activity in relation to the facility which, not being merely maintenance, results in the substitution of a new aerodrome facility for the existing aerodrome facility.

**upgrade**, for an existing aerodrome facility, means any change to the facility which, for the first time after the commencement of this MOS, enables any of the following changes to aircraft operations using the facility, namely, a change:

- (a) from day VFR operations, to night VFR operations;
- (b) from non-instrument approaches, to non-precision instrument approaches;

- (c) from non-precision instrument approaches, to precision instrument approaches;
- (d) from precision CAT I approaches, to precision CAT II or CAT III approaches;
- (e) which enables aircraft take-offs and aerodrome surface movements in runway visibility or RVR conditions of less than 550 m;
- (f) which enables the aerodrome to accommodate aircraft of a higher category specified in the ARC under section 4.01 of this MOS than was the case before the change;
- (g) which enables the aerodrome to accommodate aircraft on scheduled international operations.

*Note* The upgrade of a particular aerodrome facility that previously was not compliant with the relevant standards in the MOS is the trigger for the particular facility to be brought into compliance with the MOS. Since the timing and budgeting of an upgrade is under the aerodrome operator's control, so too is the timing of works necessary to bring the non-compliant facility into compliance with this MOS.

## 2.02 Application — new aerodromes

This MOS applies:

- (a) for an aerodrome that comes into operation for the first time after the commencement of this MOS (a *new aerodrome*); and
- (b) to the operator of a new aerodrome.

## 2.03 Application — Chapter 22

Despite anything else in this MOS, Chapter 22 applies to and for all aerodromes.

## 2.04 Application — existing aerodromes etc.

- (1) Subject to subsection (3), this MOS applies to the operator of an existing aerodrome.
- (2) Subject to subsection (3), this MOS applies for an existing aerodrome facility.
- (3) The standards in this MOS for an aerodrome facility and the obstacle limitation surfaces associated with a runway (the *OLS*) do not apply to a grandfathered facility of the same kind if the grandfathered facility:
  - (a) complies, and continues to comply, with the standards which applied to the aerodrome facility and the OLS immediately before the commencement of this MOS, as if they continued in force (the *grandfathered rules*); and
  - (b) is not:
    - (i) replaced; or
    - (ii) upgraded; and
  - (c) is maintained in accordance with the requirements of this MOS for the same kind of facility.

*Note* Subsection 2.04 (3) indicates when this MOS does not apply to the aerodrome facilities of an existing aerodrome with grandfathered status. Without grandfathered status, all of the requirements of this MOS apply. With grandfathered status, only the standards in this MOS for an *aerodrome facility* (as defined), and for the obstacle limitation surfaces associated with a runway that is, or is part of, such a facility, do not apply. Instead, the standards for the aerodrome facility and runway-associated obstacle limitation surfaces that previously applied continue to apply. Processes or systems are not aerodrome facilities (as defined) and the standards for these in this MOS apply to the operators of all existing aerodromes from the commencement of this MOS, subject to any relevant transitional provisions that may be included in Part 202 of CASR after the making of this MOS but before it commences.

- (3A) The grandfathered rules apply to a grandfathered facility and, for this purpose, the provisions of the Manual of Standards (MOS) – Part 139 Aerodromes for an aerodrome facility (the *old MOS*) (including the OLS associated with a runway) are incorporated into this MOS, as those provisions were in force immediately before 13 August 2020.

*Note Aerodrome facility* is defined in subsection 3.01 (2). See also the Note at the end of subsection (3) in relation to processes and systems.

- (3B) The requirements of this MOS in relation to an aerodrome facility apply to a grandfathered facility if it fails to comply with the grandfathered rules in accordance with this section.

*Note* The purpose of subsection (3B) is to remove any doubt that, despite the incorporation of previous standards for certain circumstances, any enforcement action for failure to comply with relevant standards provided for by this MOS will be under Part 139 of CASR and this MOS.

- (4) Subject to subsection (5), for subparagraph (3) (b) (ii), the standards in this MOS:

- (a) apply only to the upgrading of the specific elements of the facility that are being upgraded; and
- (b) do not apply to any other elements of the facility which are not being changed and which, therefore, remain grandfathered until they are either replaced or upgraded.

*Note* See CASA Advisory Circular (AC) 139.A-03: *Application of aerodrome standards*, as existing from time to time and freely available on the CASA website, for examples of how subsection (4) operates.

- (5) Without otherwise affecting subsection (4):

- (a) if a runway is upgraded, the associated OLS must then also comply with the requirements of this MOS for the upgraded runway; and
- (b) if the aerodrome reference code of the OLS associated with a runway that is part of a grandfathered facility is changed, the aerodrome reference code of that runway may remain the same but only as long as:
  - (i) the aerodrome reference code of the OLS associated with the runway is not less than the aerodrome reference code for that runway; or
  - (ii) the changed aerodrome reference code of the OLS associated with the runway does not result in 1 of the changes mentioned in paragraphs (a) to (g) of the definition of *upgrade* for that runway.

- (6) Despite anything else in this section, this MOS applies to a grandfathered facility if, before the facility is replaced or upgraded, the aerodrome operator has opted-in.

*Note* For the definition of *opted-in*, see section 2.01.

## 2.04A Application — grandfathering of new aerodrome facility developments

- (1) In this section:

*new aerodrome facility*, for an existing aerodrome other than an aerodrome that is compliant with the standards in this MOS for aerodrome facilities, means an aerodrome facility:

- (a) that did not exist at the aerodrome before 6 September 2019; and
- (b) for which the process of bringing it into existence (the *development process*) was started by the relevant or proposed aerodrome operator, before 6 September 2019; and
- (c) whose construction is completed:
  - (i) for an aerodrome facility under construction before 6 September 2019 — before 13 November 2021; and

- (ii) for an aerodrome facility not under construction before 6 September 2019 — before 13 November 2022.

**development process**, means any of the following by or for the relevant or proposed aerodrome operator, for construction of the new aerodrome facility:

- (a) construction of the new aerodrome facility was underway, provided that, not later than the end of 13 August 2020, the operator satisfies CASA that:
  - (i) the construction is intended to be completed before 13 November 2021; and
  - (ii) the operator has a demonstrable plan to achieve such completion;
- (b) final building approval was granted by such of the Commonwealth, State, Territory or Local Government authorities (**relevant authorities**) as are responsible under relevant legislation for granting such a final building approval, provided that, not later than the end of 13 August 2020, the operator satisfies CASA that:
  - (i) the construction is intended:
    - (A) to begin before 13 November 2021; and
    - (B) to be completed before 13 November 2022; and
  - (ii) the operator has a demonstrable plan to achieve such a beginning and such a completion;
- (c) funding, or funding approval, was granted by such of the relevant authorities as are empowered by relevant legislation to grant funding or approve funding for construction of such a facility, provided that, not later than the end of 13 August 2020, the operator satisfies CASA that:
  - (i) the construction is intended:
    - (A) to begin before 13 November 2021; and
    - (B) to be completed before 13 November 2022; and
  - (ii) the operator has a demonstrable plan to achieve such a beginning and such a completion;
- (d) application for a final building approval mentioned in paragraph (b), provided that:
  - (i) the application is successful, and the approval is granted before 13 November 2021; and
  - (ii) the construction is intended:
    - (A) to begin before 13 November 2021; and
    - (B) to be completed before 13 November 2022; and
  - (iii) the operator has a demonstrable plan to achieve such a beginning and such a completion; and
  - (iv) CASA is satisfied, not later than the end of 13 August 2020, that subparagraphs (ii) and (iii) are the case;
- (e) application for grant of funding, or funding approval, mentioned in paragraph (c), provided that:
  - (i) the application is successful and the funding, or funding approval, is granted before 13 November 2021; and
  - (ii) the construction is intended:
    - (A) to begin before 13 November 2021; and

- (B) to be completed before 13 November 2022; and
  - (iii) the operator has a demonstrable plan to achieve such a beginning and such a completion; and
  - (iv) the operator satisfies CASA that subparagraphs (ii) and (iii) are the case.
- (2) Subject to subsection (3), this MOS applies to the relevant or proposed aerodrome operator of a new aerodrome facility (the *new aerodrome facility*).
  - (3) The standards in this MOS for an aerodrome facility and the obstacle limitation surfaces associated with a runway (the *OLS*) do not apply to the new aerodrome facility of the same kind as long as that facility:
    - (a) complies with the standards under the Manual of Standards (MOS) – Part 139 Aerodromes for the aerodrome facility (including the OLS associated with a runway), as in force immediately before 13 August 2020 (the *relevant old MOS rules*); and
    - (b) is not:
      - (i) replaced; or
      - (ii) upgraded; and
    - (c) is maintained in accordance with the requirements of this MOS for the same kind of facility.

*Note* Subsection 2.04A (3) indicates when this MOS does not apply to a new aerodrome facility. Without this protected status, all of the requirements of this MOS would apply. With protected status, only the standards in this MOS for an *aerodrome facility* and for the obstacle limitation surfaces associated with a new runway that is, or is part of, such a new facility, do not apply. Instead, the standards for the aerodrome facility and runway-associated obstacle limitation surfaces contained in the relevant old MOS rules apply. Processes or systems are not aerodrome facilities (as defined) and, subject to any transitional provisions, the standards for these in this MOS apply to the operators of all new aerodrome facilities from the completion of construction of the facility until the facility is replaced or upgraded.

- (4) The relevant old MOS rules apply to the new aerodrome facility and for this purpose the relevant old MOS rules, including the OLS associated with a runway, as in force immediately before 13 August 2020, are incorporated into this MOS; and

*Note* *Aerodrome facility* is defined in subsection 3.01 (2). See also the Note at the end of subsection (3) in relation to processes and systems.

- (5) The requirements of this MOS apply to a new aerodrome facility if it fails to comply with the relevant old MOS rules in accordance with this section.

*Note* The purpose of subsection (5) is to remove any doubt that, despite the incorporation into this MOS of previous standards for certain circumstances (*relevant standards*), any enforcement action for demonstrable failure to comply with those relevant standards, as provided for by this MOS, will be under Part 139 of CASR and this MOS. This is because the relevant provisions of these 2 instruments constitute the default applicable rules in the event of such a failure.

- (6) Despite anything else in this section, this MOS applies to a new aerodrome facility if, before construction of the facility is completed, the relevant or proposed aerodrome operator notifies CASA, in writing, that from a specified date, sooner than would otherwise have been the case under this section, the facility will comply with the requirements of this MOS for the facility.

## 2.05 Directions to upgrade a part of an existing aerodrome or facility

- (1) Subject to subsection (2), if CASA considers that an activity at an existing aerodrome or an existing aerodrome facility would have an adverse effect on aviation safety if it were not considered to be, or deemed to be, a replacement or an upgrade, CASA may use its powers

under regulation 11.245 of CASR to direct the aerodrome operator to do 1 or more of the following:

- (a) apply this MOS to the activity as if the activity were a replacement or an upgrade;
  - (b) apply this MOS to another part of the aerodrome or facility as if that other part were directly and significantly affected by the activity.
- (2) For subsection (1), CASA must notify an aerodrome operator:
- (a) of any proposal to issue a direction under subsection (1); and
  - (b) that the operator may object to the proposal.
- (3) CASA must not issue a direction unless it has considered any objections from the operator that are received within 28 days (or such longer period as CASA permits) after the notification mentioned in subsection (2).
- (4) CASA may specify a shorter period than the 28 days mentioned in subsection (3) if CASA determines that aviation safety requires sooner consideration of the matter.
- (5) A direction, notification, permission, objection or determination mentioned in this section must be in writing.
- (6) If a direction referred to in this section is issued under regulation 11.245 of CASR, the direction ceases to be in force in accordance with regulation 11.250 of CASR.
- Note* Under regulation 11.250 of CASR, a direction ceases to be in force:
- (a) if it specifies a day on which it ceases to be in force — on the specified day; or
  - (b) if it does not specify a day for that purpose — 1 year after the day it commences.
- (7) This section:
- (a) applies subject to, and without prejudice to, CASA’s powers under Subpart 11.G of CASR; and
  - (b) may be applied only insofar as it is consistent with Subpart 11.G of CASR.

## **2.06 Non-application of the standards**

- (1) CASA may approve in writing that an operator is not required to meet a standard specified in this MOS.
- (2) An approval under subsection (1) must specify the provisions to which the approval applies, and may be 1 or more of the following:
  - (a) time-limited or open-ended as to its duration;
  - (b) made subject to conditions.
- (3) For subsection (1), CASA may grant an approval if the aerodrome operator:
  - (a) applies in writing for an approval; and
  - (b) identifies each of the relevant standards, by reference to the specific provision in the MOS, which it is proposed will not be met, and explains why it will not be met; and
  - (c) states the length of the period during which each relevant standard will not be met; and
  - (d) sets out in an accompanying safety assessment:
    - (i) the effect on aerodrome and aviation safety of not meeting each of the relevant standards; and



- (ii) either:
  - (A) the measures proposed to mitigate those effects; or
  - (B) the measures proposed to achieve the same safety outcome as the relevant standards in the MOS would achieve; and
- (e) satisfies CASA that the approval will not have any adverse effect on aviation safety.

## CHAPTER 3 DEFINITIONS ETC.

### 3.01 Definitions etc.

- (1) In this instrument:
- (a) **approval** means approval in writing by CASA, unless the contrary intention appears; and
  - (b) words and phrases have the same meaning as in Part 139 of CASR, unless the contrary intention appears in subsection (2).

*Note* Various other words and expressions used in this MOS have the same meaning as in the CASR Dictionary.

- (2) In this instrument:

**AAIS** means automatic aerodrome information service.

**accelerate-stop distance available (ASDA)** is the length of the take-off run available (TORA) plus the length of any stopway (SWY).

*Note 1* ASDA = TORA + SWY.

*Note 2* Any available clearway (CWY) or runway end safety area (RESA) is not included.

**Act** means the *Civil Aviation Act 1988*.

**ADS-B** means automatic dependent surveillance – broadcast.

**AEP** means aerodrome emergency plan.

**aerodrome** has the same meaning as in the Act.

**aerodrome beacon** means an aeronautical beacon used to indicate the location of an aerodrome from the air.

**aerodrome elevation** means the elevation of the highest point of the landing area.

**aerodrome facility** means any of the following physical things at an aerodrome as mentioned in this MOS for an aerodrome:

- (a) the physical characteristics of any movement area including runways, taxiways, taxilanes, shoulders, aprons, primary and secondary parking positions, runway strips and taxiway strips;
- (b) infrastructure;
- (c) structures;
- (d) equipment;
- (e) earthing points;
- (f) cables;
- (g) lighting;
- (h) signage;
- (i) markings;
- (j) visual approach slope indicators;

- (k) any other similar thing that is physical matter and is used for the operation of aircraft at the aerodrome.

*Note 1* Aerodrome facilities are physical matter. For example, a safety management system is not an aerodrome facility. Management and administrative processes do not constitute an aerodrome facility.

*Note 2* The expression *aerodrome facilities and equipment* is defined in the CASR Dictionary. The different expression *aerodrome facility* is defined in this MOS and has a different meaning.

***aerodrome frequency confirmation system*** means a system which:

- (a) responds automatically when a radio transmission is broadcast on an assigned aerodrome frequency; and
- (b) is used to confirm that the correct aerodrome frequency has been selected on the air-band radio.

***aerodrome layout*** is the number of runways, taxiways and aprons at an aerodrome that are provided with lighting, in 1 of the following categories of aerodrome:

- (a) basic — an aerodrome with 1 runway, with 1 taxiway to 1 apron area;
- (b) simple — an aerodrome with 1 runway, having more than 1 taxiway to 1 or more apron areas;
- (c) complex — an aerodrome with more than 1 runway, having more than 1 taxiway to 1 or more apron areas.

***aerodrome movement***, for an aircraft, means a take-off, a landing, or a touch-and-go manoeuvre at an aerodrome.

***aerodrome reference code (ARC)*** has the meaning given to it in Chapter 4 of this MOS.

***aerodrome reference point (ARP)*** means the designated geographical location of an aerodrome.

***aerodrome technical inspection*** means an inspection of the facilities, equipment and operation of a certified aerodrome, conducted by, or on behalf of, the aerodrome operator to ensure detection of any deterioration that could make any of the facilities, equipment or operations unsafe for aircraft operations.

***Aerodrome Terrain and Obstacle Chart — ICAO (Electronic)*** means an electronic chart that portrays such terrain, obstacle and aeronautical data for an aerodrome as is reasonably required to:

- (a) enable an operator to:
  - (i) carry out operating limitations analysis for aircraft using the aerodrome; and
  - (ii) know whether the operator's aircraft may land at, and take off from, the aerodrome within the operating limitations of the aircraft; and
  - (iii) develop procedures for use in the event of:
    - (A) a missed approach or take-off; or
    - (B) an emergency during landing or take-off; and
- (b) support the following activities for the safety of air navigation:
  - (i) instrument procedure design (including circling procedures);
  - (ii) aerodrome obstacle restriction and removal;

- (iii) provision of source data for the production of other aeronautical charts.

*Note* See sections 7.21 and 7.24.

**aerodrome traffic density** means the number of aircraft movements in the mean busy hour, in 1 of the following categories:

- (a) light — not greater than 15 movements per runway, or typically less than 20 total aerodrome movements;
- (b) medium — 16 to 25 movements per runway, or typically between 20 to 35 total aerodrome movements;
- (c) heavy — 26 or more movements per runway, or typically more than 35 aerodrome movements.

**aeronautical beacon** means an aeronautical ground light visible at all azimuths, either continuously or intermittently, to designate a particular point on the surface of the Earth.

**aeronautical ground light** means any light specially provided as an aid to air navigation, other than a light displayed on an aircraft.

**aeronautical study** means an investigation of a problem concerned with aircraft operations, aimed at identifying:

- (a) possible solutions (if any); and
- (b) the solution (if any) which best preserves an acceptable level of aviation safety.

*Note* CASA guidance on aeronautical studies is contained in *CASA Advisory Circular (AC) 139.A-04: Applying for aerodrome authorisations, exemptions and approvals*, as existing from time to time and freely available on the CASA website.

**aeroplane reference field length** means the minimum field length required for an aeroplane to take off at maximum certificated take-off mass, at sea level, in standard atmospheric conditions, in still air and with zero runway slope, as shown in:

- (a) the aeroplane's aircraft flight manual approved by the national aviation authority which issued the initial type certificate for the aeroplane; or
- (b) equivalent data from the aeroplane manufacturer.

**AFRU** means aerodrome frequency response unit and is the abbreviation used for an aerodrome frequency confirmation system.

**AIP** means Aeronautical Information Publication.

**AIP-ERSA** means Aeronautical Information Publication - En Route Supplement of Australia.

**aircraft classification number (ACN)** means a number expressing the relative effect of an aircraft on a pavement for a specified standard subgrade category.

*Note* For guidance see *CASA Advisory Circular (AC) 139.C-07: Strength rating of aerodrome pavements*, as existing from time to time and freely available on the CASA website.

**aircraft movement** means 1 of the following:

- (a) the landing of an aircraft at an aerodrome;
- (b) the take-off of an aircraft from an aerodrome;
- (c) a touch-and-go manoeuvre of an aircraft at an aerodrome.

**aircraft movements**, when referred to numerically for an aerodrome, for a financial year, means the numbers of aircraft movements at the aerodrome during the financial year, as compiled by the aerodrome operator or the ATS provider.

*Note* CASA may require an aerodrome operator or an ATS provider to provide it with aircraft movement data: see regulations 139.140 and 139.145 of CASR.

**aircraft parking position** means an open-air designated area on an apron for parking an aircraft.

*Note 1* An aircraft parking position is also known as an **aircraft stand**.

*Note 2* An aircraft parking position does not include any area that is within a fully or partially-enclosed aircraft hangar.

*Note 3* An area designated on an apron as being available for the parking of aircraft is considered to be an aircraft parking position.

**airline** means an aircraft operator operating aircraft in regular public transport operations.

**airside** means the following areas, access to which is restricted by the aerodrome operator, or by a Federal or State authority, to authorised persons only:

- (a) the movement area of the aerodrome;
- (b) where their purpose and use is to directly support aircraft operations — the terrain and buildings adjacent to the movement area, or particular portions of such adjacent terrain and buildings.

*Note* The word “landside” is used colloquially to denote areas of an aerodrome that are not airside, for example, passenger terminals.

**airside driver** means a person who drives or operates an airside vehicle.

**airside vehicle** means a vehicle, including equipment that is mobile under its own power, that is operated airside under the authorisation of the aerodrome operator.

**air transport operation** has the same meaning as in clause 3 of Part 2 of the CASR Dictionary.

*Note* An **aerial work operation** is not an air transport operation.

**air transport passenger** means a passenger in an air transport operation.

**air transport passenger movement numbers**, for an aerodrome, for a financial year, means the numbers, published by the Department, of air transport passenger movements at the aerodrome during the financial year, and any reference to air transport passenger movements is a reference to the movements compiled in these numbers.

**AIS provider** means a person who holds a certificate under regulation 175.055 of CASR.

**APEI** means the official publication known as *Airport Engineering Instructions* issued:

- (a) by CASA or its predecessors, before the Rules and Practices for Aerodromes (RPA) was first issued; or
- (b) otherwise by or under the authority of the Commonwealth.

**API** means the official publication known as *Airport Instructions* issued:

- (a) by CASA or its predecessors, before the Rules and Practices for Aerodromes (RPA) was first issued; or
- (b) otherwise by or under the authority of the Commonwealth.

**approved** means approved by CASA, whether with or without conditions, unless the contrary intention appears.

**apron** means a defined area on a land aerodrome to accommodate aircraft for the purposes of loading or unloading passengers, mail or cargo, fuelling, parking, or maintenance.

**apron taxiway** means a portion of a taxiway system located on an apron to provide a through taxi route for aircraft across the apron to another part of the taxiway system.

**ARC** means aerodrome reference code.

**ARFF unit**, for an aerodrome, means the aviation rescue and firefighting unit at the aerodrome.

**ARFFS** means aviation rescue and firefighting service.

**artificial**, in relation to an obstacle, object or structure, means an obstacle, object or structure made by human skill and labour.

**ATC** means air traffic control.

**ATS** means air traffic service.

**AT-VASIS** means abbreviated T visual approach slope indicator system.

**Australian Height Datum** means the datum that sets mean sea level as zero elevation.

**A-VDGS** means advanced visual docking guidance system.

**barrette** means 3 or more aeronautical ground lights closely spaced in a transverse line so that from a distance they appear as a short bar of light.

*Note* Transverse means transverse to the runway centreline.

**becomes aware** means:

- (a) in relation to an aerodrome operator's awareness of the numbers of aircraft movements at the aerodrome within a period — the operator is taken to know the relevant number of such movements as soon as a reasonable operator, monitoring such movements in any way, would know; and
- (b) in relation to an aerodrome operator's awareness of the numbers of aircraft passenger movements at the aerodrome within a period — the operator is taken to know the relevant number of such movements at the earlier of the following:
  - (i) the date of publication, if any, by the Department, of the aircraft passenger movement numbers for the aerodrome for the period;
  - (ii) as soon as a reasonable operator, monitoring such movements in any way, would know.

**bypass pad** means a pad resembling a runway turn pad except that:

- (a) it is extended beyond the declared end of the runway; and
- (b) it allows an aircraft to go around the runway end stripe and runway end lights before turning around 180 degrees to use the runway in a reciprocal direction.

**CA/GRO** means a certified air/ground radio operator.

**CA/GRS** means a certified air/ground radio service.

**CAR** means the *Civil Aviation Regulations 1988*.

**CASR** means the *Civil Aviation Safety Regulations 1998*.

**CAT**, when referring to an instrument approach, means category.

**CAVOK** means that cloud, visibility and present weather are better than the prescribed values or conditions.

*Note* CAVOK is sometimes referred to as “ceiling and visibility OK”.

**Chicago Convention** means the Convention on International Civil Aviation.

**civil aviation safety legislation** means the *Civil Aviation Act 1988*, the regulations made under the Act, and instruments, including Civil Aviation Orders and Manuals of Standards, made under the Act or the regulations, and other instruments made under any of the foregoing.

**clearway (CWY)** means a defined area at the end of the TORA, on the ground or water under the control of the aerodrome operator, that is selected or prepared as a suitable area over which an aeroplane may make a portion of its initial climb to a specified height.

**CNS** means communications, navigation, surveillance.

**Configuration A**, for runway guard lights, has the meaning given in subsection 9.99 (1).

**Configuration B**, for runway guard lights, has the meaning given in subsection 9.99 (1).

**critical obstacle** means the obstacle within the take-off climb area, or within the approach area, or within both areas, which subtends the greatest vertical angle when measured from the inner edge of the take-off climb surface and/or the approach surface.

**CTAF** means common traffic advisory frequency.

**CVOR** means conventional VOR.

**daylight** means the period between the beginning of morning civil twilight and the end of evening civil twilight.

**declared distances** means the following:

- (a) take-off run available (TORA), being the length of runway declared available and suitable for the ground run of an aeroplane taking off;  
*Note* TORA may include additional length available from a starter extension if provided.
- (b) take-off distance available (TODA), being the length of the take-off run available plus the length of the clearway, if provided;
- (c) accelerate-stop distance available (ASDA), being the length of the take-off run available plus the length of the stopway, if provided;
- (d) landing distance available (LDA), being the length of runway which is declared available and suitable for the ground run of an aeroplane landing.

**Department** has the meaning given in item 1 in subsection 19A (1) of the *Acts Interpretation Act 1901*.

*Note* “Department” means the Department of State of the Commonwealth that is administered by the Minister who, from time to time, administers CASR. At the date of making, this is the Department of Infrastructure, Regional Development and Cities but may change from time to time in accordance with Administrative Arrangements Orders made by the Governor-General.

**dependent parallel approaches** means simultaneous approaches to parallel or near-parallel instrument runways where radar separation minima between aircraft on adjacent extended runway centrelines are prescribed.

**design slope**, for any aerodrome facility, means that, at the design stage of construction, the design of the slope must fall within the range of values expressed in the relevant Table or provision of this MOS for the design slope.

**displaced threshold** means a threshold not located at the extremity of a runway.

**DME** means distance measuring equipment.

**D value**, for a rotorcraft, is the rotorcraft's maximum dimension when rotors are turning, and is the distance in metres measured from:

(a) the most forward position of the main rotor tip path plane of the rotorcraft;

to:

(b) the most rearward position of the tail rotor tip path plane or of the rotorcraft's fuselage.

*Note* "D value" is a common design term used in ICAO Annex 14, Aerodromes, Volume II, Heliports. For ICAO documents, see section 1.07.

**DVOR** means the Doppler VOR.

**earth mat area** means the area of virgin ground that is directly underneath, and in immediate proximity to, a communications, navigation, surveillance site.

**effective intensity**, for a flashing light, is equal to the intensity of a fixed light of the same colour, which will produce the same visual range under identical conditions of observation.

**elevation** means the vertical distance of a point or a level, on or affixed to the surface of the Earth, measured from mean sea level.

**exit taxiway** means a taxiway connected to a runway to enable landing aeroplanes to turn off the runway.

**facility** has the same meaning as aerodrome facility.

**FATO area** means a final approach and take-off area of an aerodrome used for helicopter operations.

**fixed light** means a light having constant luminous intensity when observed from a fixed point.

**FOD** means foreign object debris, which may result in foreign object damage to an aircraft.

**frangible object** means an object of low mass designed to break, distort or yield on impact so as to present the minimum hazard to aircraft.

**GBAS** means a ground-based augmentation system comprised of a VHF data broadcast (VDB) antenna and (typically) 4 remote satellite measurement unit (RSMU) antennas, with each of these components:

(a) separately located; and

(b) performing specific functions; and

(c) with different siting requirements and restrictions.

**GLS** means GBAS landing system, and is a GNSS alternative to an ILS for approach and landing operations using a GBAS as the primary navigational reference.

**GNSS** means Global Navigation Satellite System.

**gravel**, for a surface, means that the surface is comprised of gravel and any binding additives but is not sealed.



**hazard beacon** means an aeronautical beacon used to designate a danger to air navigation.

**HF** means the high frequency band, that is radio frequencies in the range 3 000 to 30 000 kHz.

**holding bay** is a defined area where aircraft can be held or bypassed to facilitate efficient surface movement of aircraft.

*Note* Generally, such an area is offset from the taxiway so that clearance for passing aircraft is maintained.

**homogeneous runway surface** means a runway surface that has a consistent surface finish across its full width.

*Note* A non-homogeneous runway surface means a runway surface that has different surface finishes across its full width. A non-homogeneous runway surface may result in differing friction, loading, and wet weather characteristics. Thus, it may limit the operations of some aircraft types depending on the requirements of the aircraft flight manual.

**IATA** means International Air Transport Association.

**ICAO** means the International Civil Aviation Organization established under the Chicago Convention.

*Note* For ICAO documents, see section 1.07.

**ICAO Annex**, for a numbered ICAO document, means the Annex, of that number, to the Chicago Convention.

**ICAO Annex 4** means Annex 4, Aeronautical Charts.

**IFR** means instrument flight rules, and has the same meaning as that given in CAR for I.F.R.

**ILS** means an instrument landing system comprised of the following components:

- (a) VHF localizer equipment;
- (b) UHF glide path equipment;
- (c) VHF marker beacons or distance measuring equipment (DME);
- (d) localizer far field monitor antennas.

*Note* Each component of an ILS performs specific functions, and is separately located along the longitudinal axis of, or alongside, the runway. Different siting requirements, and restrictions to access and movement, apply to each site.

**ILS critical area** means an area about the localizer and glide path antennas where vehicles and aircraft must be excluded during all ILS operations because the presence of vehicles or aircraft inside the area will cause unacceptable disturbance to the ILS signal-in-space.

**ILS sensitive area** means an area extending beyond the ILS critical area:

- (a) where the parking and movement of vehicles and aircraft is controlled to prevent the possibility of unacceptable interference to the ILS signal during ILS operations; and
- (b) which is protected against interference caused by large moving objects outside the ILS critical area but still normally within the airfield boundary.

**independent parallel approaches** means simultaneous approaches to parallel or near-parallel instrument runways where radar separation minima between aircraft on adjacent extended runway centrelines are not prescribed.

**independent parallel departures** means simultaneous departures from parallel or near-parallel instrument runways.

**instrument approach procedures** means a series of predetermined manoeuvres by reference to flight instruments with specified protection from obstacles from the initial approach fix or, where applicable, from the beginning of a defined arrival route to a point from which a landing can be completed and thereafter, if a landing is not completed, to a position at which holding or en route obstacle clearance criteria apply.

**instrument meteorological conditions (IMC)** means meteorological conditions expressed in terms of visibility, distance from cloud, and ceiling, less than the minimum specified for visual meteorological conditions.

**instrument runway** means 1 of the following types of runway nominated for the operation of aircraft using instrument approach procedures:

- (a) non-precision approach runway, being a runway, served by visual aids and non-visual aids, intended for landing operations following an instrument approach operation with a minimum descent height or decision height (DH) at or above 250 ft (a **type A operation**) in runway visibility of not less than 1 000 m;
- (b) precision approach runway, Category (**CAT**) I, being a runway, served by visual aids and non-visual aids, intended for landing operations following an instrument approach operation with a DH lower than 250 ft (a **type B operation**) but not lower than 200 ft, and either:
  - (i) in visibility of not less than 800 m; or
  - (ii) with an RVR of not less than 550 m;
- (c) precision approach runway, Special Authorisation Category I (**SA CAT I**), being a runway, served by visual aids and non-visual aids, nominated for landing operations following an instrument approach type B operation with a DH lower than 200 ft but not lower than 150 ft, and an RVR of not less than 450 m;
- (d) precision approach runway, Special Authorisation Category II (**SA CAT II**) being a runway, served by visual aids and non-visual aids, nominated for landing operations following an instrument approach type B operation with a DH lower than 200 ft but not lower than 100 ft, and an RVR of not less than 350 m;
- (e) precision approach runway, CAT II, being a runway, served by visual aids and non-visual aids, nominated for landing operations following an instrument approach type B operation with a DH lower than 200 ft, but not lower than 100 ft, and an RVR of not less than 300 m;
- (f) precision approach runway, CAT III, being a runway, served by visual aids and non-visual aids, for landing operations following an instrument approach type B operation to and along the surface of the runway and:
  - (i) for CAT IIIA — nominated for operations with a DH lower than 100 ft or with no decision height, and an RVR of not less than 175 m; and
  - (ii) for CAT IIIB — nominated for operations with a DH lower than 50 ft or with no decision height, and an RVR of less than 175 m but not less than 50 m; and
  - (iii) for CAT IIIC — nominated for operations with no DH or RVR limitations.

*Note 1* Instrument approach procedures are classified as follows:

- (a) Non-precision approach (NPA) procedure: an instrument approach procedure designed for 2D instrument approach type A operations.
- (b) Approach procedure with vertical guidance (APV): a performance-based navigation (PBN) non-precision instrument approach procedure designed for 3D instrument approach type A operations.

- (c) Precision approach (PA) procedure: an instrument approach procedure based on navigation systems (ILS, MLS, GLS and SBAS CAT I) designed for 3D instrument approach type A or B operations.

*Note 2* When preparing or nominating their infrastructure to support the desired aircraft operation, the aerodrome operator determines the classification of instrument runway for which the runway is to be nominated provided that the relevant standards in this MOS are achieved. A certified designer under Part 173 of CASR may then be tasked to design the optimal terminal instrument flight procedure to the capabilities of the instrument runway.

*Note 3* Special Authorisation Category operations may only be utilised by aircraft operators who meet specific requirements for flight crew competency, aircraft capability and any conditions relevant to the terminal instrument flight procedure.

*Note 4* The visual aids provided need not necessarily be matched to the scale of the non-visual aids provided. CASA recommends that visual aids should be determined based on the requirements for the intended classification of operation and in consultation with the aircraft operators for whom it is intended to be utilised.

***intermediate holding position*** means a designated holding position for traffic control, at which taxiing aircraft and vehicles:

- (a) must stop and hold only if so instructed by the aerodrome control tower; and
- (b) if so stopped, must not proceed until given clearance by the aerodrome control tower.

***international aerodrome*** means an aerodrome:

- (a) designated by the Department as an international airport in Australia (a ***designated international airport in Australia***); and
- (b) identified as a designated international airport in Australia on the Department's website.

*Note* Generally, scheduled international air transport operations are conducted only at international aerodromes. The list of designated international airports in Australia may be accessed by navigating from the following link: [https://infrastructure.gov.au/aviation/international/icao/design\\_airports.aspx](https://infrastructure.gov.au/aviation/international/icao/design_airports.aspx).

***international air transport operation*** means an international air transport operation whether or not it is conducted in accordance with a published schedule.

***jet blast*** means the thrust force from an aircraft jet or turbofan engine when the aircraft is on or close to the ground.

***LAHSO*** means land and hold short operations.

***landing area*** means that part of a movement area for the landing or take-off of aircraft.

***landing distance available (LDA)*** means the length of runway (RWY) available for the ground run of a landing aeroplane. The LDA commences at the runway threshold.

*Note 1* LDA = length of RWY (if threshold is not displaced).

*Note 2* The stopway (SWY) and clearway (CWY) are not part of the LDA.

***light failure*** means that:

- (a) the light is deemed to be unserviceable (that is, in a failed state) when the main beam average intensity:
  - (i) is less than 50% of the value specified in the appropriate figure showing the isocandela diagram; or
  - (ii) ceases to illuminate; and
- (b) for paragraph (a), for light units with the designed main beam average intensity higher than the value shown in the isocandela diagram — the 50% value must be related to that higher design value; and

- (c) when assessing the main beam — specified angles of beam elevation, toe-in and beam spread must be taken into consideration.

**lighting system outage** means that a light or lighting system is experiencing a deteriorated performance level (including total failure) which requires:

- (a) the fixing of the light or lighting system as soon as possible; and  
(b) a report to be made to AIS provider requesting that a NOTAM be issued.

**lighting system reliability** means the probability that the complete installation operates within the specified tolerances and that the system is operationally usable.

**low-visibility procedure (LVP)** means a procedure applied at an aerodrome for protecting aircraft operations during conditions of reduced visibility or low cloud.

**LVP** means low-visibility procedure.

**MAGS** means movement area guidance sign.

**manoeuvring area** means that part of the aerodrome to be used for the take-off, landing and taxiing of aircraft, excluding aprons.

**marked:**

- (a) when used in relation to a marking — refers to the marking; and  
(b) when used in relation to a marker — refers to the marker.

**marker** means an object displayed above ground level in order to indicate an obstacle or delineate a boundary.

**marking** means a symbol or group of symbols displayed on the surface of the movement area of an aerodrome to convey surface movement, or aeronautical, information.

**mass** and **weight**, as used in this MOS, have the same meaning.

**MAUM** means maximum all-up mass.

**MET** means meteorological.

**method of working plan (MOWP)** means a plan to ensure that aerodrome works do not present a hazard to aircraft operations.

**MLS** means microwave landing system.

**movement area** means that part of an aerodrome to be used for the take-off, landing and taxiing of aircraft, consisting of the manoeuvring area and the aprons.

**movements**, for the definition of **aerodrome traffic density**, means the sum of the following:

- (a) each take-off of an aircraft with passengers on board;  
(b) each landing of an aircraft with passengers on board;  
(c) each aerodrome movement that is a touch-and-go manoeuvre.

**MTOM** means maximum take-off mass.

**MTOW** means maximum take-off weight.

**NDB** means non-directional beacon.

**near-parallel instrument runways** means non-intersecting runways whose extended centrelines have an angle of convergence/divergence of 15 degrees or less.

**nominated**, for an ARC, means nominated by the aerodrome operator.

**non-instrument runway** means a runway for the operation of aircraft using visual approach procedures.

**non-precision approach runway** has the meaning given to it in paragraph (a) of the definition of **instrument runway**.

**NOTAM** means Notice to Airmen, and is a notice issued by the NOTAM Office containing information or instructions concerning the establishment, condition or change in any aeronautical facility, service, procedure or hazard, the timely knowledge of which is essential to persons concerned with flight operations.

**obstacle-free zone (OFZ)** means the airspace above the inner approach surface, inner transitional surface, baulked landing surface, and that portion of the runway strip bounded by these surfaces, which is not infringed by any fixed obstacle other than a low mass and frangibly mounted one required for air navigation purposes.

**obstacle limitation surfaces (OLS)** means a series of planes, associated with each runway at an aerodrome, that defines the desirable limits to which objects or structures may project into the airspace around the aerodrome so that aircraft operations at the aerodrome may be conducted safely. The obstacle limitation surfaces are as follows:

- (a) the outer horizontal surface;
- (b) the conical surface;
- (c) the inner horizontal surface;
- (d) the approach surface;
- (e) the inner approach surface;
- (f) the transitional surface;
- (g) the inner transitional surface;
- (h) the baulked landing surface;
- (i) the take-off climb surface.

**obstacle restriction area** consists of the runway strips, runway end safety areas, clearways and taxiway strips.

**obstacles** means fixed (whether temporarily or permanently) and mobile objects, structures, and parts of such objects and structures, that:

- (a) are located on an area provided for the surface movement of aircraft; or
- (b) extend above a defined surface designated to protect aircraft in flight; or
- (c) stand outside the defined surfaces mentioned in paragraphs (a) and (b) and that have been assessed as being a hazard to air navigation.

**OMGWS** means outer main gear wheel span.

**PAL** means pilot-activated lighting system.

**PANS-OPS** means Doc.8168-OPS/611 Volume II (Procedures for Air Navigation Services – Construction of Visual and Instrument Flight Procedures) approved and published by decision of the Council of the International Civil Aviation Organization, as in force or existing from time to time.

**PAPI** means precision approach path indicator.

**passenger movement numbers**, in relation to an aerodrome for a period, means the sum of the total numbers of passengers who arrive at, or depart from, the aerodrome for the period:

- (a) as published by the Department; or
- (b) if paragraph (a) does not apply — as calculated in accordance with a method approved in writing by CASA.

**paved**, for a surface, means that the surface is prepared as a pavement.

**pavement** means a surface that is constructed from a combination of a sub-base, a base course, and a surface course, placed on a subgrade to support the traffic load and distribute it to the subgrade.

*Note* A subgrade is a prepared foundation or the natural surface on which the pavement is constructed.

**pavement classification number (PCN)** means a number expressing the bearing strength of a pavement for unrestricted operations by aircraft with aircraft classification number (ACN) less than or equal to the PCN.

*Note* For guidance see CASA Advisory Circular (AC) 139.C-07: *Strength rating of aerodrome pavements*, as existing from time to time and freely available on the CASA website.

**pilot**, when used in relation to the location of a thing relative to the pilot of an aircraft, means the pilot in command of the aircraft, unless the contrary intention appears.

**PPE** means personal protective equipment.

**precision approach runway** means a runway described in paragraph (b), (c), (d), (e) or (f) of the definition of **instrument runway**.

**precision approach terrain chart — ICAO** is a chart providing detailed terrain profile information for a defined portion of the final approach to a runway to enable an aircraft operator to assess the effects of the terrain when determining decision height using radio altimeters.

**primary runway** means a runway used in preference to other runways whenever conditions permit.

**pushback vehicle** includes a pushback unit.

**QNH** means altimeter subscale setting to obtain elevation (on the ground) or altitude.

**rapid exit taxiway** means a taxiway connected to a runway at an acute angle, designed to allow landing aeroplanes to turn off the runway at higher speeds than are achieved on exit taxiways, thereby minimising runway occupancy times.

**reference elevation datum** has the same meaning as in section 7.04.

**road holding position** is a designated position at which vehicles may be required to hold.

**RSM** means remote satellite measurement.

**RSMU** means remote satellite measurement unit.

**RTAO** means restrictions to aircraft operations.

**RTIL** means runway threshold identification lights.

**Rules and Practices for Aerodromes** means the official publication known as Rules and Practices for Aerodromes issued:

- (a) by CASA or its predecessors, before the Manual of Standards (MOS) — Part 139 Aerodromes was first published by CASA on 1 May 2003; or

(b) otherwise by or under the authority of the Commonwealth.

**runway (RWY)** means a defined rectangular area on a land aerodrome prepared for the landing and take-off of aircraft.

**runway end safety area (RESA)** means an area symmetrical about the extended runway centreline and adjacent to the end of the runway strip, primarily to reduce the risk of damage to an aeroplane which undershoots or overruns the runway.

**runway guard light** means a light system provided to caution pilots or vehicle drivers that they are about to enter an active runway.

**runway holding position** means a designated position at a controlled aerodrome that is provided to protect a runway, an obstacle limitation surface, or an ILS or MLS critical or sensitive area, at which taxiing aircraft and vehicles must stop and hold, unless otherwise authorised by the aerodrome control tower.

*Note* For the use of runway holding positions at non-controlled aerodromes, refer to CAAP 166-1.

**runway inner shoulders** means the portion of the runway shoulders immediately adjacent to the runway.

**runway starter extension** means an additional length of pavement that:

- (a) is immediately before the runway threshold; and
- (b) increases the distance available for take-off; but
- (c) must not be used for landing.

**runway slope** means the slope of a runway, presented as a percentage deviation from the horizontal. It is calculated by dividing the difference between the maximum and minimum deviations from the horizontal along the runway centreline, by the runway length, multiplying the quotient by 100 and expressing the product as a percentage deviation from the horizontal.

**runway strip** means a defined area, including the runway and stopway, provided to:

- (a) reduce the risk of damage to aircraft running off a runway; and
- (b) protect aircraft flying over the runway during take-off or landing operations.

**runway type FATO** means the final approach and take-off area of an aerodrome having characteristics similar in shape to a runway.

**runway visibility (RV)** means the distance along a runway over which a person can see and recognise a visibility marker or runway lights.

**runway visual range (RVR)** has the same meaning as in the CASR Dictionary.

**SA** means special authorisation.

**SALS** means a simple approach lighting system.

**scheduled air transport operation** means an air transport operation conducted in accordance with a published schedule.

**scheduled domestic air transport operation** means an air transport operation conducted in Australia in accordance with a published schedule.

**scheduled international air transport operation** means an international air transport operation conducted in accordance with a published schedule.

**sealed**, for a surface, means that the surface is wholly, or preponderantly, sealed with a surface treatment which may include bitumen, asphalt, concrete or another suitable treatment.

**secondary power supply**, for an aerodrome's functionality, means an electrical power supply that:

- (a) is automatically connected to the relevant load when the primary power source fails; and
- (b) is derived from:
  - (i) the normal public electrical power supply, but in a way that:
    - (A) supplies power for the aerodrome's functionality from a special substation that is not the normal substation; and
    - (B) supplies the power through a special transmission line that follows a route different from the normal power supply route; and
    - (C) makes extremely remote the possibility of a simultaneous failure of the normal public electrical power supply and the power supply for the aerodrome; or
  - (ii) 1 or more generators, batteries, or similar devices which deliver a constant, reliable and sufficient supply of electrical power for the relevant aerodrome service.

*Note* See also sections 9.03 and 9.04.

**segregated parallel operations** means simultaneous operations on parallel or near-parallel instrument runways in which 1 runway is used exclusively for approaches and the other runway is used exclusively for departures.

**SGS** means satellite ground station.

**shoulders** means an area adjacent to the edge of a pavement so prepared as to provide a transition between the pavement and the adjacent surface.

**signal circle** means an area on an aerodrome used for the display of ground signals.

**SMS** means safety management system, and includes the statements and documents mentioned in Chapter 25 that describe and support the system.

**stopway (SWY)** means a defined rectangular area on the ground at the end of the take-off run available prepared as a suitable area in which an aircraft can be stopped in the case of an abandoned take-off.

**STODA** means supplementary take-off distance available.

**Supply Authority** means the body for an area that is approved, licensed or authorised by the State or Territory government of the area (the *polity*), or by the legislation of that polity, to supply electrical power to the general public of the area.

**switch-over time**, for a light, means the time required for the actual intensity of a light measured in a given direction to fall from 50% and recover to 50% during a power supply changeover when the light is being operated at intensities of 25% or above.

**tabletop exercise** means a theoretical discussion in which an emergency event is simulated, usually with timescales significantly compressed, and relevant persons verbally describe how they respond to the emergency but without any physical demonstration of the actual response.



**take-off distance available (TODA)** is the full length of the runway plus the length of any clearway. However, if there is no designated clearway, the part of the runway strip between the end of the runway and the runway strip end must be included as part of the TODA.

*Note* TODA = TORA + CWY.

**take-off run available (TORA)** is the full length of the runway available in the relevant take-off direction.

*Note 1* TORA = length of RWY.

*Note 2* Neither stopway (SWY) nor clearway (CWY) are included in the TORA.

**take-off runway** means a runway designated for take-off only.

**taxilane** means a portion of an apron designated as a taxiway and for use only to provide access to, and egress from, aircraft parking positions.

*Note* A fully or partially enclosed aircraft hangar is not within the meaning of **aircraft parking position**, as defined.

**taxiway (TWY)** means a defined path on an aerodrome on land, established for the taxiing of aircraft from 1 part of an aerodrome to another. A taxiway includes a taxilane, an apron taxiway and a rapid exit taxiway.

*Note* **Taxilane**, **apron taxiway**, **exit taxiway**, **rapid exit taxiway** and **taxiway system** are also defined terms.

**taxiway intersection** means a junction of 2 or more taxiways.

**taxiway strip** means an area including a taxiway provided to protect an aircraft operating on the taxiway and to reduce the risk of damage to an aircraft which accidentally runs off the taxiway.

**taxiway system** means a number of interconnecting taxiways.

**threshold** means the beginning of that portion of the runway usable for landing.

**time-limited works** means aerodrome works that may be carried out if normal aircraft operations are not disrupted and the movement area can be restored to normal safety standards in not more than 30 minutes.

**touchdown zone** means the portion of a runway, beyond the threshold, where landing aeroplanes are to first contact the runway.

**traffic density** has the same meaning as **aerodrome traffic density**.

**transient obstacle** includes a mobile obstacle.

**T-VASIS** means T visual approach slope indicator system.

**Type A chart** is a chart which contains information on all significant obstacles within the take-off area of an aerodrome up to 10 km from the end of the runway.

**Type B chart** is an obstacle chart which provides obstacle data from around the aerodrome.

**UHF** means the ultra high frequency band, that is radio frequencies in the range 300 to 3 000 MHz.

**UNICOM** (universal communications) means a non-air traffic control communication facility operated to provide an advisory service to enhance the value of information normally available at a non-controlled aerodrome.

**unsealed**, for a surface, means that the surface is not sealed.

**VASI** means visual approach slope indicator.

**VASIS** means a visual approach slope indicator system.

**VDB** means VHF data broadcast.

**VDGS** means a visual docking guidance system.

**VFR** means visual flight rules, and has the same meaning as that given in CAR for V.F.R.

**VHF** means the very high frequency band, that is radio frequencies in the range 30 to 300 MHz.

**visibility (V)** means visibility for aeronautical purposes and is the greater of the following:

- (a) the greatest distance at which a black object of suitable dimensions, situated near the ground, can be seen and recognised when observed against a bright background;
- (b) the greatest distance at which lights in the vicinity of 1 000 candelas (cd) can be seen and identified against an unlit background.

*Note 1* The 2 distances have different values in air of a given extinction coefficient, and the distance mentioned in paragraph (b) varies with the background illumination. The distance mentioned in paragraph (a) is represented by the meteorological optical range (MOR).

*Note 2* For international recognition and consistency, the definition of **visibility** is taken from ICAO Annex 3, Meteorological Service for International Air Navigation, Chapter 1, Part 1. For ICAO documents, see section 1.07.

**visibility marker** means a dark object of suitable dimensions for use as a reference in evaluating runway visibility.

**visual aids** means visual aids to navigation in the form of markers, markings, lights, signs, signals, displays or wind direction indicators, or combinations of these, which provide information to aircraft and vehicles on, or using, the movement area of an aerodrome.

**visual meteorological conditions (VMC)** means meteorological conditions expressed in terms of visibility, distance from cloud, and ceiling, equal to or better than specified minima.

**VOR** means VHF omnidirectional radio range.

**WAM** means wide area multilateration.

**weight** and **mass**, as used in this MOS, have the same meaning.

**wheelbase** means the distance from the nose gear to the geometric centre of the main gear.

**Y location code** means the international code prefix used to identify Australian aerodromes.

Example: YMML identifies Melbourne Airport.

- (3) In addition to any relevant definitions contained in subsection (2), the following definitions apply for applicable provisions in relation to runway surface conditions:

**contaminant** means matter present on the surface of a runway that meets one or more of the following runway surface condition descriptors:

- (a) **compacted snow**, being snow that has been compacted into a solid mass such that aeroplane tyres, at operating pressures and loadings, will run on the surface without significant further compaction, or rutting of the surface;
- (b) **dry snow**, being snow from which a snowball cannot readily be made;
- (c) **frost**, being frost that consists of ice crystals formed from airborne moisture on a surface whose temperature is below freezing;

*Note 1* Frost differs from ice in that the frost crystals grow independently and, therefore, have a more granular texture.

*Note 2* Below freezing refers to air temperature equal to or less than the freezing point of water (0 degrees Celsius).

*Note 3* Under certain conditions, frost can cause the surface to become very slippery and it is then reported appropriately as reduced braking action.

- (d) **ice**, being water that has frozen, or compacted snow that has transitioned into ice, in cold and dry conditions;
- (e) **slush**, being snow that is so water-saturated that it will splatter if stepped on forcefully, or from which water will drain when a handful is picked up;
- (f) **standing water**, being water of a depth greater than 3 mm;

*Note* By convention, running water of a depth greater than 3 mm is reported as standing water.

- (g) **wet ice**, being ice with water on top of it, or ice that is melting;

*Note* Freezing precipitation can lead to runway conditions associated with wet ice in relation to aeroplane performance. Wet ice can cause the surface to become very slippery. It is then reported appropriately as reduced braking action in accordance with section 12.04A of this MOS. For guidance, see also Multi-Part AC 91-32 and AC 139-22 v2.0, Global reporting format – Runway surface condition.

- (h) **wet snow**, being snow that contains enough water content to be able to make a well-compacted, solid snowball, and from which water will not squeeze out.

*Note* A runway is contaminated when one or more contaminants are present on the surface of the runway.

**runway condition assessment matrix** or **RCAM** means a matrix for assessing the runway condition code from a set of observed runway surface conditions and the pilot in command's report on braking action.

**runway condition code** or **RWYCC** is the number used in a runway condition report to describe the runway surface condition.

*Note* The runway condition code allows the flight crew to make an operational aeroplane performance calculation in accordance with section 12.04A of this MOS. For guidance, see also Multi-Part AC 91-32 and AC 139-22 v2.0, Global reporting format – Runway surface condition.

**runway condition report** or **RCR** means a comprehensive standardised report relating to runway surface conditions, and their effect on aeroplane landing and take-off performance.

**runway surface condition descriptors**: see **contaminant**.

**slippery wet runway** means a wet runway where the surface friction characteristics of a significant portion of the runway show that the runway is degraded.

*Note* These definitions are for use in relation to Global Reporting Format.

## CHAPTER 4 AERODROME REFERENCE CODE AND DETERMINATION OF AERODROME STANDARDS

### 4.01 Aerodrome Reference Code

- (1) The standards which an aerodrome facility must meet to be suitable for use by aeroplanes within a particular range of performance and size are determined by the aerodrome reference code (**ARC**) chosen by the aerodrome operator.
- (2) The ARC is made up of 3 elements:
  - (a) a code number determined by the aeroplane reference field length (**code number** or **runway code number**); and
  - (b) a code letter determined by the aeroplane wingspan (**code letter**); and
  - (c) the outer main gear wheel span (**OMGWS**).
- (3) The aerodrome operator must select from Table 4.01 (3) the code number corresponding to the highest value of the aeroplane reference field length of the aeroplanes which the aerodrome facility is nominated by the operator to serve.

*Note* When making a selection, CASA recommends that an aerodrome operator should consider the aircraft types and operations to be accommodated because it is such considerations which dictate the appropriate design, and operating and reporting standards, for the facility.

**Table 4.01 (3) ARC number (or runway code number)**

Code element 1	
Code number	Aeroplane reference field length
1	Less than 800 m
2	Not less than 800 m
3	Not less than 1 200 m
4	Not less than 1 800 m

*Note* The minimum aeroplane reference field length determines the code number. However, provided it meets at least the minimum length required for a particular code number, the actual runway length does not otherwise dictate the code number selected by an operator. The practical minimum length for the runway, and the nominated ARC, are each selected by the aerodrome operator.

- (4) The aerodrome operator must select from Table 4.01 (4) the code letter corresponding to the greatest wingspan of the aeroplanes which the aerodrome facility is nominated by the operator to serve.

*Note* The choice of the greatest wingspan lies with the aerodrome operator. A failure to choose that which is the most demanding of applicable options may result in operational limitations for a particular aircraft type.

**Table 4.01 (4) ARC letter**

<b>Code element 2</b>	
<b>Code letter</b>	<b>Wingspan</b>
A	Up to but not including 15 m
B	15 m up to but not including 24 m
C	24 m up to but not including 36 m
D	36 m up to but not including 52 m
E	52 m up to but not including 65 m
F	65 m up to but not including 80 m

- (5) The aerodrome operator must select from Table 4.01 (5) the greatest OMGWS of the aeroplanes that the aerodrome or facility is nominated by the operator to serve.

**Table 4.01 (5) OMGWS**

<b>Code element 3</b>
OMGWS up to but not including 4.5 m
OMGWS 4.5 m up to but not including 6 m
OMGWS 6 m up to but not including 9 m
OMGWS 9 m up to but not including 15 m

*Note* The choice of OMGWS lies with the aerodrome operator. A failure to choose that which is the most demanding of applicable options may result in operational limitations for a particular aircraft type.

## **CHAPTER 5      AERODROME INFORMATION FOR THE AIP AND THE AERODROME MANUAL**

### **Division 1    Information**

#### **5.01    Information for the AIP through an AIS provider**

- (1) An aerodrome operator must report the information specified in subsection (2) to an AIS provider for publication in the AIP.
- (2) The information for subsection (1) is information about the following, in accordance with, or as supplemented under, sections 5.03 to 5.09:
  - (a) the aerodrome;
  - (b) the movement area;
  - (c) the visual aids;
  - (d) the navigation aids;
  - (e) the rescue and firefighting services;
  - (f) the ground services;
  - (g) the aerodrome operational procedures.
- (3) The information mentioned in subsection (1) must be reported in the format specified by the AIS provider.

#### **5.02    Information to be included in aerodrome manual**

The aerodrome manual must contain all of the information mentioned in subsection 5.01 (2) that is reported to the AIS provider.

#### **5.03    Aerodrome information**

An aerodrome diagram

- (1) A single aerodrome diagram must illustrate the following:
  - (a) the layout of runways, taxiways and aprons;
  - (b) the nature of the runway surfaces;
  - (c) the designations and lengths of the runways;
  - (d) the designations of the taxiways;
  - (e) the location of illuminated and non-illuminated wind direction indicators;
  - (f) the location of the aerodrome reference point;
  - (g) the location of the terminal buildings;
  - (h) the location of any helicopter runway type FATO areas or helicopter aiming points;
  - (i) the location of any glider runway strips, if located external to a runway strip;
  - (j) the location and type of a VASIS, if provided.

### Aerodrome administration statement

- (2) An aerodrome administration statement must include the following:
- (a) the aerodrome operator's name, postal address, telephone number, email address, website and facsimile number (where applicable);
  - (b) the name and telephone number of the person nominated by the operator to be the contact for any matters arising outside normal business hours;  
*Note* The relevant email address and facsimile number (where applicable) should also be provided.
  - (c) whether the aerodrome is for part military use, public use, private use or a combination of these uses.  
*Note* Aerodrome use charges may also be included in the statement.
- (3) For paragraphs (2) (a) and (b), the telephone numbers, email addresses and facsimile numbers must be numbers or addresses that are regularly monitored for incoming calls, emails or faxes.

### Aerodrome location statement

- (4) An aerodrome location statement must include the following for the aerodrome:
- (a) its name;
  - (b) the State or Territory in which it is located;
  - (c) the latitude and longitude based on the aerodrome reference point;
  - (d) the Y location code indicator;
  - (e) the elevation;
  - (f) the currency of any Type A and B charts.

## 5.04 Movement area information

### Runways

- (1) For each runway designation, the information must include the following:
- (a) the runway code number;  
*Note* See paragraph 4.01 (2) (a).
  - (b) the runway bearings, in degrees magnetic;
  - (c) the length and width of the runway and its surface type, or, if non-homogeneous runway surfaces are provided across the length and width of the runway, the runway surface types;  
*Note* See also Note 4 under Table 6.02 (1).
  - (d) for instrument runways:
    - (i) the geographic location coordinates of the threshold; and
    - (ii) the elevation of the midpoint of the runway threshold;
  - (e) the strength rating of the runway pavement calculated using the ACN – PCN pavement rating system;
  - (f) the length and width of the runway strip;

- (g) the runway slope;
- (h) the runway declared distances and STODA;
- (i) the established OLS for the runway;
- (j) if published — relevant:
  - (i) Type A charts for any significant obstacles within the take-off area up to 10 km from the end of the runway; and
  - (ii) Type B charts for any other obstacles around the aerodrome;
- (k) identification of any obstacle-free zone;
- (l) identification of any arrester system, its location and description.

### Runway strip availability

- (2) If the aerodrome operator prepares the runway strip and makes it available for take-offs and landings, the information must include details of:
  - (a) such availability; and
  - (b) any limitations on such availability.

*Note* The provision of a glider runway strip is an example of runway strip availability. See also Chapter 6, Division 6.

### Taxiways

- (3) For each taxiway, the information must include the following:
  - (a) the aerodrome reference code letter;
  - (b) the width;
  - (c) the surface type;
  - (d) the designation.

### Aprons

- (4) For each apron of an aerodrome with international operations, the information must include the following:
  - (a) the surface type;
  - (b) the location, elevation and designation of any aircraft parking position or stand;
  - (c) details of any parking guidance provided.
- (5) For each apron of an aerodrome that does not have international operations, the information:
  - (a) must include the surface type; and
  - (b) may include the location and designation of any aircraft parking position or stand.



## 5.05 Visual aids

### Approach and runway lighting systems

- (1) The information must include details of the following (as applicable) for approach and runway lighting systems:
  - (a) the type, length and intensity of the approach lighting system;
  - (b) the runway threshold lights, colour and wing bars;
  - (c) the type of visual approach slope indicator system;
  - (d) the length of the runway touchdown zone lighting;
  - (e) the length, longitudinal spacing, colour and intensity of the runway centreline lights;
  - (f) the length, longitudinal spacing, colour and intensity of the runway edge lights;

*Note* The references to intensity in paragraphs (a), (e) and (f), refer to the number of stages as described in the data product specification under Part 175 of CASR.

- (g) the colour of the runway end lights and wing bars;
- (h) the length and colour of the stopway lights;
- (i) the starter extension lighting;
- (j) runway threshold identification lights (RTIL);
- (k) pilot-activated lighting system (PAL).

### Other lighting and secondary power supply

- (2) The information must include details of the following:
  - (a) the location, characteristics and hours of operation of any aerodrome beacons;
  - (b) the lighting systems for taxiways, including taxi holding positions and stop bars;
  - (c) the lighting systems for aprons, including the location and type of VDGSs;
  - (d) any other movement area lighting systems;
  - (e) any obstacle lighting provided for OLS infringements;
  - (f) any secondary power supply, including its switch-over time.

## 5.06 Navigation aids

The information must include details of any navigation aid provided by the aerodrome operator.

## 5.07 Rescue and firefighting services

The information must include the category of any rescue and firefighting service (ARFFS) provided by the aerodrome operator and based at the aerodrome.

## 5.08 Ground services

The information must include details of the following:

- (a) fuel suppliers and their contact details, including regularly monitored after-hours contact details;

- (b) any aerodrome weather information broadcasts provided by the aerodrome operator;
- (c) ground-to-air communication systems, for example UNICOM, aerodrome frequency response units (AFRU) and approved air-ground operator services provided by the aerodrome operator;
- (d) any other aviation-related services made available to pilots by the aerodrome operator.

## **5.09 Aerodrome operational procedures**

### Standard taxi routes

- (1) The information must include the location and designation of standard taxi routes determined by:
  - (a) the aerodrome operator; or
  - (b) the ATS provider.

### Special procedures

- (2) The information must include any special procedures unique to the aerodrome which pilots would reasonably be expected to know in the interests of aviation safety.

### Notices

- (3) The information must include cautionary or administrative information relating to the safe use of the aerodrome.

### Low-visibility procedures

- (4) If low-visibility procedures are established at the aerodrome — the information must include the following:
  - (a) the runways and equipment used under low-visibility procedures;
  - (b) the defined meteorological conditions under which low-visibility procedures are initiated, used and terminated;
  - (c) the ground markings and lighting used under low-visibility procedures.

## CHAPTER 5

### Division 2 Standards for information

#### 5.10 Standards for information published in the AIP through an AIS provider

- (1) In this section and section 5.11:  
*DPS* means the AIS provider's data product specification (as in force or existing from time to time) that is required under regulation 175.160 of CASR.
- (2) The information mentioned in subsections 5.01 (1) and (2) must be determined and reported to the AIS provider in accordance with:
  - (a) the DPS; and
  - (b) regulation 175.460 for the DPS.
- (3) The information mentioned in sections 5.12 to 5.17 must be reported or provided to the AIS provider in accordance with:
  - (a) the DPS; or
  - (b) if there is no DPS for the information — in accordance with the requirements (if any) specified in sections 5.12 to 5.17.

#### 5.11 Standards for information to be included in aerodrome manual

- (1) The information mentioned in section 5.02 must be determined and reported in the aerodrome manual in accordance with the DPS.
- (2) The information mentioned in sections 5.12 to 5.17 must be reported in, or provided with, the aerodrome manual in accordance with:
  - (a) the DPS; or
  - (b) if there is no DPS for the information — in accordance with the requirements (if any) specified in sections 5.12 to 5.17.

#### 5.12 Movement area – runways – declared distances information

##### Runways

- (1) For each runway direction, the following distances must be reported in metres, with feet equivalent shown in brackets:
  - (a) take-off run available (TORA);
  - (b) take-off distance available (TODA);
  - (c) accelerate-stop distance available (ASDA);
  - (d) landing distance available (LDA).

*Note* The expressions used in this subsection are defined in section 3.01.

##### Intersection departure take-off distances available

- (2) At an aerodrome where air traffic procedures allow taxiway intersection departures, the TODA from each relevant taxiway intersection must be reported.

*Note* The method of determining the take-off distances available at an intersection is similar to that used at a runway end. This is to ensure that the same performance parameters (for example, line-up allowance) are

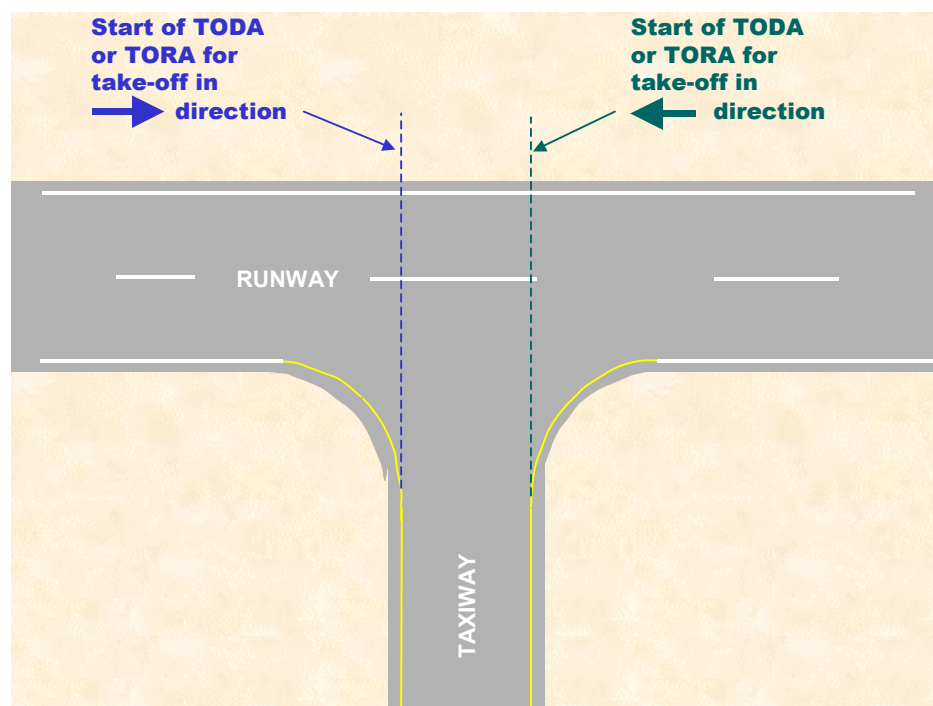
consistently applied for the line-up manoeuvre, whether entering the runway at the runway end or from some other intersection.

- (3) Where a taxiway intersection is at right angles to the runway, the TODA from the taxiway intersection must be measured from the perpendicular line that:
  - (a) continues the taxiway edge; and
  - (b) is behind the aircraft when it commences its take-off roll.

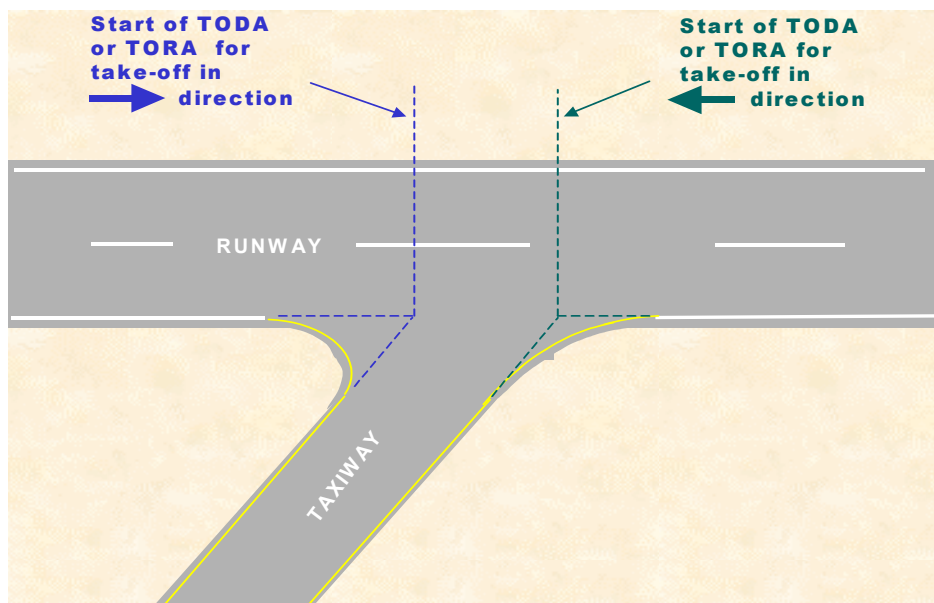
*Note* This is illustrated in Figure 5.12 (3).

- (4) Where a taxiway intersection is not at right angles to the runway, the TODA from the taxiway intersection must be measured from the perpendicular line that is:
  - (a) from the point where the continuation of the taxiway edge meets the runway edge; and
  - (b) behind the aircraft when it commences its take-off roll.

*Note* This is illustrated in Figure 5.12 (4).



**Figure 5.12 (3) Calculation of intersection departure information for a perpendicular runway entry (illustrates matters)**



**Figure 5.12 (4) Calculation of intersection departure information for a non-perpendicular runway entry (illustrates matters)**

- (5) Intersection departure information must be reported as follows:
- RWY [runway designation] — TKOF from TWY [taxiway designation];
  - RWY remaining [in metres and feet] — Reduce all DIST by [reduced distance, in metres and feet].

*Note* Here is an example of how to record the information:

- RWY 14 — TKOF from TWY A;
  - RWY remaining 1085 (3560) — Reduce all DIST by 360 (1181).
- (6) The code number of the OLS standard under section 7.16 for each runway must be reported in accordance with section 5.04.

*Note* For the applicable runway code number, see Table 4.01 (3).

- (7) The selection of the critical obstacle must be based on:
- a survey of the full take-off surface in accordance with the nominated runway code number; and
  - the applicable OLS standards specified in Chapter 7 of this MOS.
- (8) The gradient from the end of the TODA to the top of the critical obstacle within the take-off climb area must be reported as a percentage figure. However, if there is no obstacle, a value of 1.2% must be reported.

#### Fences or levee banks

- (9) If a fence or levee bank is located so close to a runway strip end that the take-off gradient is greater than 5%, the take-off gradient may be reported based on the next most critical obstacle within the take-off area provided that a note is added:
- advising that the fence or levee bank has not been taken into account in the calculation of the TODA and STODA gradients; and
  - giving the location and height of the fence or levee bank.

### Supplementary take-off distance available (STODA)

- (10) For a TODA having an obstacle clear gradient of more than 1.6%, the STODA must be reported for obstacle clear take-off gradients of 1.6%, 1.9%, 2.2%, 2.5%, 3.3% and 5%, up to the gradient associated with the TODA, unless the corresponding STODA for a particular gradient is less than 800 m.

*Note* In calculating the STODA, care must be taken to ensure that a shielded object does not become critical for the lesser take-off distances, and that the slope of the runway is taken into account.

### Threshold elevation

- (11) For an instrument runway, the elevation of the midpoint of the runway threshold must be reported, measured in feet to an accuracy of 1 foot, based on the Australian Height Datum (AHD).

### Aerodrome obstacle charts — Types A and B

- (12) If a Type A or B chart is prepared, its currency must be reported by reference to:
- (a) its date of preparation; or
  - (b) its sequential edition or issue number.

### Precision approach terrain chart

- (13) If an aerodrome obstacle chart is provided by an aerodrome operator, it must be in accordance with the standards and procedures set out in ICAO Annex 4.

*Note* For ICAO documents, see section 1.07.

### Aerodrome Terrain and Obstacle Chart — ICAO (Electronic)

- (14) If an aerodrome terrain and obstacle chart is provided by an aerodrome operator, it must be prepared and published as an Aerodrome Terrain and Obstacle Chart — ICAO (Electronic), in accordance with ICAO Annex 4.

*Note* For ICAO documents, see section 1.07.

### One-direction runways

- (15) If a runway direction cannot be used for take-off or landing, the declared distance must be reported as “nil” and accompanied by an explanation.

Example: “TKOF 14 and LAND 32 not AVBL due surrounding terrain.”

## 5.13 Movement area — taxiways

### Taxiway width

- (1) The minimum width of the taxiway must be reported in metres.

### Nature of taxiway surface

- (2) The taxiway surface type must be reported as 1 of the following:
- (a) bitumen seal;
  - (b) asphalt;
  - (c) concrete;
  - (d) gravel;

- (e) grass;
- (f) natural surface.

*Note* For example, “dirt” would be a natural surface.

- (3) If only the central portion of the taxiway is sealed, this must be reported.

*Note* This would relate to a non-homogeneous runway surface.

#### Taxiway designation

- (4) For the taxiway record:
  - (a) each main taxiway and each short feeder taxiway must have a designation; and
  - (b) subject to paragraph (c), the designation must be a single letter used without numbers; and
  - (c) for each short feeder taxiway — an alpha-numeric designator may be used.

### 5.14 Movement area — aprons

#### Nature of apron surface

- (1) The apron surface type must be reported as 1 of the following:
  - (a) bitumen seal;
  - (b) asphalt;
  - (c) concrete;
  - (d) gravel;
  - (e) grass;
  - (f) natural surface.

*Note* For example, “dirt” would be a natural surface.

- (2) The location and coordinates of all primary and secondary parking positions must be reported:
  - (a) for an aerodrome that has scheduled international air transport operations; and
  - (b) for an aerodrome without scheduled international air transport operations — if the operator has supplied parking position designations to an AIS provider for publication in the AIP.

*Note* See also subsections 5.04 (4) and 5.04 (5).

- (3) For subsection (2):
  - (a) a location must be reported in degrees, minutes, seconds and hundredths of seconds of latitude and longitude; and
  - (b) elevation must be reported to the nearest foot.

### 5.15 Visual aids

#### Lighting systems

- (1) All aerodrome lighting systems must be reported using the abbreviations set out in the AIP.

*Note* Runway lights include runway edge, threshold and runway end lights, and, where stopways are provided, stopway lights.

### Visual Docking Guidance System (VDGS) including Advanced Visual Docking Guidance System (A-VDGS)

- (2) For an aerodrome apron of a kind mentioned in subsection 5.04 (4) or 5.04 (5), the type of guidance system must be reported as follows:
  - (a) if a VDGS or A-VDGS is provided — the type of system;
  - (b) if a pilot stop line is provided in lieu of a VDGS or A-VDGS — the word “Pilot”;
  - (c) if a marshaller is provided in lieu of a VDGS or A-VDGS — the word “Marshaller”.

## 5.16 Navigation aids

If the aerodrome operator provides a navigation aid, the geographic location coordinates and operating frequency must be recorded.

## 5.17 Additional hazard information

Local hazards that may adversely affect aviation safety (local hazard data) must be recorded, including the following:

- (a) operating restrictions on the manoeuvring area;
- (b) continual wildlife hazards at the aerodrome or in its vicinity, including descriptions, locations, and times or seasonal information;

*Note* Requirements for managing wildlife hazards are specified in Chapter 17. As a guide, the aerodrome vicinity, for the purposes of wildlife hazards, may be considered as being:

- (a) for sources of attractants and wildlife movements which present a hazard — within a radius of 3 km from all the runways of an aerodrome; and
- (b) for significant sources of attractants or hazardous wildlife movements across the aerodrome site — within a radius of 8 km from the aerodrome reference point.
- (c) apron or parking position restrictions outside daylight hours;
- (d) any activities within the circuit area that are hazardous to aviation;

*Note* For example shooting ranges, explosive areas (such as mine sites or military ordinance practice areas), wind farms or sources of gaseous plumes (such as gas driven generators, refineries or furnaces).

- (e) other aviation activities such as helicopter, ultralight or glider operations within the circuit area.

*Note* In general terms, for aircraft engaged in general aviation with an approximate climb rate of 500 ft per minute, the circuit area may be considered as being within a radius of 3 km of the aerodrome reference point. For higher performance turboprop or jet engine aircraft, CASA recommends that a larger area should be considered for the circuit or circling area.



## CHAPTER 6      AERODROME PLANNING, DESIGN AND MAINTENANCE — PHYSICAL CHARACTERISTICS OF MOVEMENT FACILITIES

### Division 1    Runways

#### 6.01    Location of runway threshold

- (1) Subject to this section, as far as possible, a runway threshold must be located at the extremity of a runway.
- (2) A runway threshold must be located:
  - (a) for a code 1 runway — not less than 30 m; or
  - (b) in any other case — not less than 60 m;after the point at which the approach surface for aircraft using the runway meets the extended runway centreline.
- (3) Subject to subsection (2), a runway threshold may be displaced from the extremity of a runway if:
  - (a) the OLS would otherwise be infringed by an obstacle; or
  - (b) the PANS-OPS airspace would otherwise be infringed by an obstacle; or
  - (c) an immovable object or structure would otherwise extend above the approach surface.

*Note 1* CASA Advisory Circular (AC) 139.A-04: *Applying for aerodrome authorisations, exemptions and approvals*, and AC 139.C-08: *Aerodrome obstacle control*, as existing from time to time and freely available on the CASA website, contain important guidance on the various safety factors that an aerodrome operator should consider before displacing a runway threshold.

*Note 2* Thresholds should not be displaced without consideration of aircraft operational factors, such as approach angle and LDA. Large approach angles (above 3.5 degrees) can only be flown by aircraft that have been certified for steep approaches and where the aircraft operator has received approval. Furthermore, displaced thresholds will result in a reduced LDA which may affect the safety and efficiency of the operation even if the approach angle remains at 3 degrees.

- (4) A runway threshold must be displaced from the extremity of a runway in accordance with a written direction by CASA given in the interests of aviation safety.
- (5) If a runway threshold is temporarily displaced, the aerodrome operator must:
  - (a) assess the revised approach splay for the OLS, and notify CASA in writing of any new obstacles in the approach surface; and
  - (b) recalculate the TODA, the critical obstacle gradient, and the STODA in the reciprocal direction from the displacement; and
  - (c) report any changes resulting from the recalculation to the AIS provider and request that a NOTAM be issued.
- (6) The aerodrome operator must set out in the aerodrome manual the details of, and reasons for, any permanent runway threshold displacement.

#### 6.02    Runway width

- (1) For a runway with a code number mentioned in a row of column 1 of Table 6.02 (1), the minimum width of runway for an aircraft with an OMGWS mentioned in the same row in

column 2, 3, 4 or 5, is the width in metres mentioned in the cell that is common to the code number and the aircraft's OMGWS.

**Table 6.02 (1) Minimum runway width**

Code number	OMGWS			
	Up to but not including 4.5 m	4.5 m up to but not including 6 m	6 m up to but not including 9 m	9 m up to but not including 15 m
1	18 m	18 m	23 m	–
2	23 m	23 m	30 m	–
3	30 m	30 m	30 m	45 m
4	–	–	45 m	45 m

*Note 1* OMGWS means outer main gear wheel span.

*Note 2* The combinations of code numbers and OMGWS for which widths are specified have been developed for typical aeroplane characteristics.

*Note 3* The choice of minimum runway width lies with the aerodrome operator having regard to the aircraft type which the facility is nominated to serve, bearing in mind that an aircraft must be operated in accordance with its aircraft flight manual or supplement which specifies the required minimum runway width. The minimum runway widths presented in Table 6.02 (1) do not guarantee that all aircraft types correlating to a code number and the corresponding OMGWS will be able to utilise the runway in accordance with the aircraft flight manual or supplement. Aerodrome and aircraft operators should consult with each other to ensure that aircraft may safely utilise the runway width provided at the aerodrome.

*Note 4* The runway width determined in accordance with this MOS is normally considered to be the width of a runway of homogeneous runway surface material. If an aerodrome operator chooses to provide a runway width consisting of non-homogeneous runway surface material, aircraft operations to the reported runway width may be limited. For example, a runway with an 18 m centre-sealed surface and 2.5 m of adjacent rolled gravel on each side is not considered to be a 23 m runway for the purposes of minimum width determination as documented in the aircraft flight manual or supplement.

- (2) A runway nominated as Code F for use by aircraft with at least 4 wing-mounted engines (that is, at least 2 engines on each wing) must:
  - (a) have a minimum width of 45 m; and
  - (b) have load-bearing shoulders in accordance with section 6.11.
- (3) For a precision approach runway — the runway width must not be less than 30 m.

### 6.03 Runway turn pad and runway bypass pad

- (1) If a runway turn pad or runway bypass pad is provided at any point on a runway, then, for an aircraft with an OMGWS mentioned in a row of column 1 of Table 6.03 (1):
  - (a) the minimum clearance of the outer main gear wheels of the aircraft from the edge of the relevant pad when carrying out a turn must not be less than the clearance mentioned in the same row in column 2; and
  - (b) the width of the relevant pad must be designed accordingly.

**Table 6.03 (1) Minimum clearance between outer main gear wheels and edge of turn pad or bypass pad on runway**

OMGWS	Minimum clearance
Up to but not including 4.5 m	1.5 m
4.5 m up to but not including 6 m	2.25 m
6 m up to but not including 9 m	3 m on straight portions
	3 m on curved portions — for aeroplanes with a wheelbase less than 18 m
	4 m on curved portions — for aeroplanes with a wheelbase equal to or greater than 18 m
9 m up to but not including 15 m	4 m

*Note* CASA recommends that the radius of the curve leading into and out of the runway turn pad or runway bypass pad should be compatible with the manoeuvring capability and normal taxiing speeds of the aeroplanes for which the relevant pad is intended. The intersection angle into the relevant pad should not be greater than 30 degrees. The relevant pad design should then guide the aeroplane in such a way as to allow a straight portion of taxiing before the point where a 180 degree turn is to be made. The straight portion of the relevant pad design, into and out of the relevant pad, should be parallel to the runway.

- (2) Subject to subsection (3), a runway turn pad or a runway bypass pad must be located on the right-hand side of a runway as viewed when looking in the direction of take-off from that runway end (the *normal side*).

*Note 1* This configuration would be viewed as being on the left-hand side by the pilot entering the runway turn pad or runway bypass pad, prior to the aircraft performing a reciprocal turn within the node, ready for take-off.

*Note 2* See Figure 8.33 (1).

- (3) A turn pad or bypass pad may be located on the opposite side of a runway from the normal side as described in subsection (2), but only if:

- (a) the presence of aerodrome facilities or infrastructure makes it impracticable to locate the turn pad or bypass pad on the normal side; and
- (b) the placement on the side opposite the normal side does not adversely affect safety for the take-off and landing of aircraft; and
- (c) the fact of placement on the side opposite the normal side is described and recorded in the aerodrome manual.

- (4) If:

- (a) a taxiway shoulder in accordance with section 6.11 is required for a taxiway serving a runway; and
- (b) an engine of an aeroplane using the turning node would otherwise travel outside the area defined by the turning node or the runway shoulder;

then a shoulder must be provided to a minimum distance of 3 m from the runway turn pad, or runway bypass pad, edge, and the shoulder must:

- (c) slope downwards and away from the relevant pad surface; and
- (d) be resistant to aeroplane engine blast erosion; and

- (e) be capable of supporting an aeroplane running off the relevant pad on to a shoulder without the aeroplane sustaining any structural damage; and
  - (f) be capable of supporting emergency and service vehicles; and
  - (g) either:
    - (i) preferably be flush to the relevant pad edge; or
    - (ii) if not flush with the relevant pad surface — not step down by more than 25 mm.
- (5) A runway turn pad or runway bypass pad must ensure containment of the aircraft wingspan within the width of the applicable taxiway strip, as required under section 6.48.
- (6) An additional runway turn pad or bypass pad may be provided on the opposite side to that of the pad required under subsection (2).

*Note* Such a configuration may be required to allow an aircraft with a longer wheel base of oversteer characteristics to manoeuvre safely within the turning node or bypass node.

#### **6.04 Runway starter extension**

- (1) For a runway with a starter extension not otherwise incorporated in a runway bypass pad, the starter extension design, and the associated aircraft taxi guidelines, must:
- (a) be not more than 150 m in length; and
  - (b) provide the minimum distance from the wingtip of the aircraft to each of the following located in proximity to the starter extension:
    - (i) any object;
    - (ii) a runway holding position;
    - (iii) a vehicle access road; and
  - (c) provide a minimum clearance of the outer main gear wheels of the aircraft from the edges of the starter extension that is not less than the clearance mentioned in the row in column 2 of Table 6.03 (1) that is for the OMGWS of the aircraft; and
  - (d) achieve the runway surface requirements of section 6.09; and
  - (e) achieve the runway strength requirements of section 6.10.
- (2) For paragraph (1) (b), the minimum distance must be at least 20% of the maximum wingspan of an aircraft with the aircraft code letter for which the runway starter extension is intended.

*Note* For the applicable aircraft code letter, see Table 4.01 (4).

#### **6.05 Parallel runways**

- (1) For non-instrument runways that are parallel and for simultaneous use — the minimum separation distance between the runway centrelines must not be less than the following:
- (a) if the higher code number of the two runways is 3 or 4 — 210 m;
  - (b) if the higher code number of the two runways is 2 — 150 m;
  - (c) if the code number of the two runways is 1 — 120 m.

- (2) For instrument runways that are parallel and for simultaneous use — the minimum separation distance between the runway centrelines must not be less than the following:
  - (a) for independent parallel approaches — 1 035 m;
  - (b) for dependent parallel approaches — 915 m;
  - (c) for segregated parallel operations — 760 m;
  - (d) for independent parallel departures — 760 m.

*Note* CASA recommends that non-instrument runways built after the commencement of this MOS should conform to the standards set out in subsection (2) rather than subsection (1) because this would ensure they are able to support future instrument runway operations.

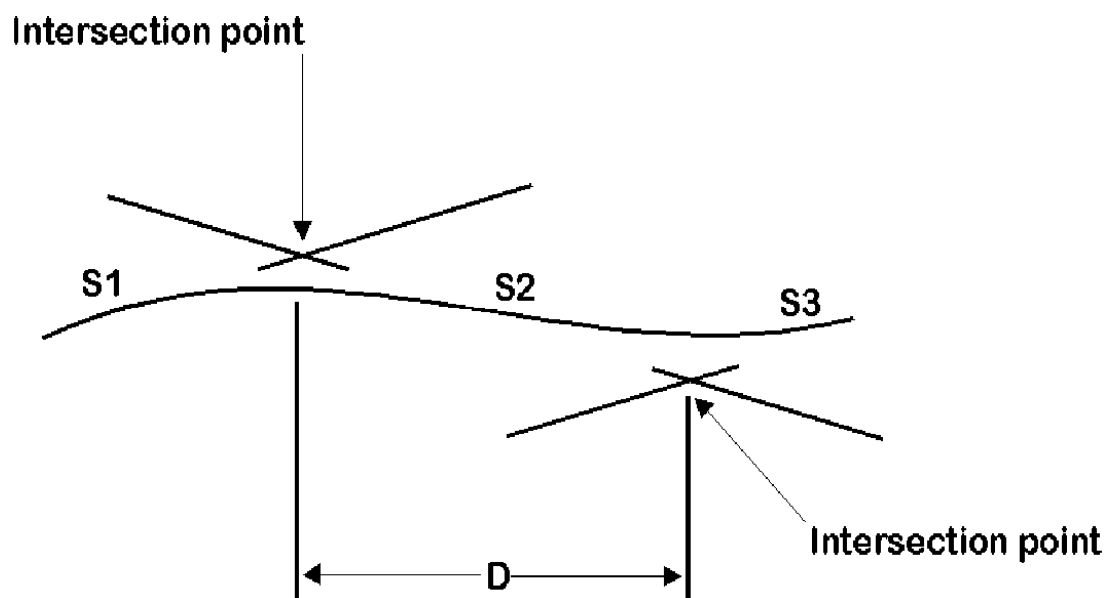
## 6.06 Runway longitudinal slope

- (1) The overall longitudinal slope of a runway must not exceed:
  - (a) for a code 3 or 4 runway — 1%; or
  - (b) for a code 1 or 2 runway — 2%.
- (2) Subject to subsections (3), (4) and (5), the longitudinal slope along any individual 45 m segment of a runway with multiple slopes must not exceed:
  - (a) for a code 4 runway — 1.25%; or
  - (b) for a code 3 runway — 1.5%; or
  - (c) for a code 1 or 2 runway — 2%.
- (3) For a code 4 runway, the longitudinal slope along the first and the last quarters of the runway must not exceed 0.8%.
- (4) For a precision approach CAT II or CAT III code 3 runway — the longitudinal slope along the first and last quarters of the runway must not exceed 0.8%.
- (5) If slope changes cannot be avoided, the change in longitudinal slope between any 2 adjoining 45 m segments of the runway must not exceed the following:
  - (a) for a code 3 or 4 runway — 1.5%;
  - (b) for a code 1 or 2 runway — 2%.
- (6) The transition from 1 longitudinal slope to another must be accomplished by a vertical curve with a rate of change not exceeding:
  - (a) for a code 4 runway — 0.1% for every 30 m (with a minimum radius of curvature of 30 000 m); or
  - (b) for a code 3 runway — 0.2% for every 30 m (with a minimum radius of curvature of 15 000 m); or
  - (c) for a code 1 or 2 runway — 0.4% for every 30 m (with a minimum radius of curvature of 7 500 m).
- (7) The maximum runway longitudinal slope values expressed in subsections (1) to (6) do not apply at the intersection of a runway with another runway or a taxiway if:
  - (a) there are conflicting drainage requirements or slope requirements; and

- (b) alternative runway longitudinal slope values are as follows:
- (i) arrived at after a safety analysis using the safety management system and the risk management plan;
  - (ii) as close as practicable to values expressed in subsections (1) to (6);
  - (iii) demonstrably safe for aircraft operations;
  - (iv) recorded in the aerodrome manual.
- (8) The distance between the points of intersection of 2 successive longitudinal slope changes must be at least the greater of:
- (a) 45 m; or
  - (b) the distance (D) in metres worked out using the formula:
- $$D = k [ |S1 - S2| + |S2 - S3| ] / 100.$$
- (9) For subsection (8):
- (a) **k** means:
    - (i) for a code 4 runway — 30 000 m; or
    - (ii) for a code 3 runway — 15 000 m; or
    - (iii) for a code 1 or 2 runway — 5 000 m; and
  - (b) “S1”, “S2” and “S3” are the 3 successive slopes expressed as percentage values and represented as absolute numerical values.

*Note* Figure 6.06 (9) shows an example of that part of the calculation for the distance between the points of intersection of 2 successive longitudinal slope changes, that is required by subsection 6.06 (8), where the runway is the transverse line running from higher left to lower right.

If the runway code number is 3, and the slopes are S1 (+1%), S2 (-1.5%) and S3 (+1.5%), then the distance in metres between the 2 points of intersection must not be less than  $15\,000 \times (2.5 + 3) / 100$ , that is to say 825 m.



**Figure 6.06 (9) Part of the calculation for the distance between the points of intersection of 2 successive longitudinal slope changes (illustrates matters)**

## 6.07 Runway sight distance

- (1) For a runway with a code letter mentioned in a row of column 1 of Table 6.07 (1), the minimum unobstructed line of sight along the surface of a runway must not be less than the distance mentioned in the row of column 2 of the Table that is for the code letter.

**Table 6.07 (1) Runway line of sight**

Code letter	Minimum unobstructed line of sight
A	From a point 1.5 m above the runway to any other point 1.5 m above the runway for half the length of the runway.
B	From a point 2 m above the runway to any other point 2 m above the runway for half the length of the runway.
C, D, E or F	From a point 3 m above the runway to any other point 3 m above the runway for half the length of the runway.

*Note* CASA recommends that runways for aircraft codes both above and below Code C should use the Code A minimum unobstructed line of sight. This would ensure superior visibility for aircraft with lower pilot eye heights when measured above the runway surface.

- (2) If runway lighting is provided for a runway with a code letter mentioned in a row of column 1 of Table 6.07 (2), the minimum unobstructed line of sight to the runway end lights must not be less than the distance mentioned in the row of column 2 of the Table that is for the code letter, when viewed at the height mentioned in the row.

**Table 6.07 (2) Line of sight to runway end lights**

Code letter	Minimum unobstructed line of sight to runway end lights
A	200 m — when viewed at a height of 1.5 m above the surface.
B	400 m — when viewed at a height of 2 m above the surface.
C, D, E or F	600 m — when viewed at a height of 3 m above the surface.

## 6.08 Transverse slopes on runways

- (1) The transverse slope on any part of a runway must not permit the pooling or ponding of water on the runway.
- (2) For design purposes, a transverse slope on a runway must be within the range of the percentage figures in column 1 in Table 6.08 (2) but a construction tolerance above or below the range is allowed within the limits specified in column 2.

**Table 6.08 (2) Runway transverse slope values**

Design slope	Construction tolerance
1.0% - 2.0%	± 0.5%

- (3) The runway transverse slope values expressed in Table 6.08 (2) do not apply at the intersection of a runway with another runway or a taxiway if:
  - (a) there are conflicting drainage requirements or slope requirements; and
  - (b) alternative runway transverse slope values are as follows:
    - (i) arrived at after a safety analysis using the safety management system and the risk management plan;

- (ii) as close as practicable to the values expressed in Table 6.08 (2);
- (iii) demonstrably safe for aircraft operations;
- (iv) recorded in the aerodrome manual.

## 6.09 Runway surface

- (1) The surface of a sealed runway:
  - (a) must not have any irregularities that:
    - (i) excluding markings, impair the minimum runway surface friction required under paragraph (1) (b) or subsection (5); or
 

*Note* CASA recommends that paint which, when applied, would leave a thick film, should be avoided, for example, paint normally used for vehicle road markings.
    - (ii) otherwise adversely affect the safety of take-off or landing; and
  - (b) subject to subsection (5), must have:
    - (i) for an un-grooved surface — an average surface texture depth of at least that stated in column 1 of Table 6.09 (1)-1 over the full length and width of the runway, as measured using sand patch tests in accordance with subsection (2); or
    - (ii) for any surface — a minimum measured coefficient of friction level greater than the minimum friction level specified in Table 6.09 (1)-2; and
  - (c) if the surface is grooved — must have grooves that are:
    - (i) perpendicular to the runway centreline; and
    - (ii) if compliance with subparagraph (i) is not physically possible — parallel to transverse joints that are not perpendicular to the runway centreline; and
    - (iii) extended as close as possible to the runway edge.

**Table 6.09 (1)-1 Average surface texture depth**

Minimum average texture depth	Preferred average texture depth
0.625 mm	1 mm

*Note* Average means the average of results within a test area, and not results averaged across multiple test areas.

- (2) Tests that satisfy paragraph (1) (b) must be carried out in accordance with ICAO Airport Services Manual, Part 2, Pavement Surface Conditions, triggered by any of the following:
  - (a) as soon as possible after a newly constructed or overlaid surface is completed;
  - (b) as soon as possible after the application of a surface treatment or surface enrichment to any part of the runway;
  - (c) in accordance with a written direction from CASA;
  - (d) so that not more than 10 years elapses between any 2 tests.

*Note* For ICAO documents, see section 1.07.
- (3) Tests that satisfy subparagraph (1) (b) (i) must be carried out as follows:
  - (a) at intervals along the full length of the runway;
  - (b) at locations no more than 10% of runway length apart;



- (c) at successive test locations on alternating sides of the runway centreline;
  - (d) at locations offset 4 m from the runway centreline except that the third test location on each side must be 1 m from the runway edge.
- (4) Grooving may be omitted within 100 m of the runway end provided paragraphs (1) (a) and (b) are both satisfied for the sections where grooving is omitted.
- (5) Despite paragraph (1) (b), for an aerodrome used for scheduled international air transport operations, the runway surface friction level must continuously achieve whichever of the following is applicable:
- (a) for a new, renewed or reconstructed surface — unless impracticable, at least the preferred friction level specified in column 7 of Table 6.09 (1)-2, applied in accordance with subsection (6);
  - (b) for the maintenance planning of an existing surface — unless impracticable, at least the preferred friction level specified in column 6 of Table 6.09 (1)-2, applied in accordance with subsection (6);
  - (c) for any surface where it is impracticable to achieve the level specified in paragraph (a) or (b) — at least the minimum friction level specified in column 5 of Table 6.09 (1)-2, applied in accordance with subsection (6).

*Note* Subsection 1.08 (3) relevantly provides that a reference in a Table to a value that is **preferred** means that, as far as practicable, the use of the value is required in priority to another value expressed in the Table although the other value expressed must be used or observed if the preferred value is not used because it is impracticable to do so. Where the preferred value is not complied with, the aerodrome manual must contain a statement to that effect, the reasons for non-compliance, and the alternative value that is complied with.

**Table 6.09 (1)-2 Friction values for continuous friction measuring devices**

Test equipment	Test tyre pressure (kPa)	Test speed (km/h)	Test water depth (mm)	Minimum friction level	Preferred Maintenance Planning Level	Preferred Design objective (for new, renewed or reconstructed surfaces)
Mu-meter trailer	A 70	65	1.0	0.42	0.52	0.72
	A 70	95	1.0	0.26	0.38	0.66
Skiddometer trailer	B 210	65	1.0	0.50	0.60	0.82
	B 210	95	1.0	0.34	0.47	0.74
Surface friction tester vehicle	B 210	65	1.0	0.50	0.60	0.82
	B 210	95	1.0	0.34	0.47	0.74
Runway friction tester vehicle	B 210	65	1.0	0.50	0.60	0.82
	B 210	95	1.0	0.41	0.54	0.74
TATRA friction tester vehicle	B 210	65	1.0	0.48	0.57	0.76
	B 210	95	1.0	0.42	0.52	0.67
RUNAR Trailer	B 210	65	1.0	0.45	0.52	0.69
	B 210	95	1.0	0.32	0.42	0.63
GRIPTESTER trailer	C 140	65	1.0	0.43	0.53	0.74
	C 140	95	1.0	0.24	0.36	0.64

- (6) For the test equipment mentioned in a row of column 1 of Table 6.09 (1)-2, the minimum friction level for a test tyre pressure, test speed and test depth of water mentioned in the same row of columns 2, 3, and 4 respectively, is that mentioned in the same row of column 5, 6 or 7 that, in accordance with subsection (5), is for the particular pressure, speed or depth.
- (7) The surface of a grass, gravel or natural runway or runway strip:
  - (a) must meet the surface standards set out in Table 6.09 (7); and
  - (b) must not have any irregularities that:
    - (i) result in the loss of frictional characteristics; or
    - (ii) otherwise adversely affect the safety of take-off or landing.
- (8) For Table 6.09 (7), a surface characteristic mentioned in a row of column 1 must meet the standard for the characteristic mentioned in the same row in column 2 for runways, and column 3 for runway strips.

**Table 6.09 (7) Standards for a grass, gravel or natural runway or runway strip**

Surface	Runway	Runway strip
Maximum height of grass	150 mm	300 mm
Maximum size of isolated, loose stones on natural or constructed gravel surfaces	25 mm	50 mm
Maximum size of surface cracks (transverse)	40 mm	75 mm
Maximum size of surface cracks (longitudinal)	25 mm	75 mm

- (9) For subparagraph (1) (a) (ii), whether or not any irregularities adversely affect the safety of take-off or landing must be determined by a safety analysis using the safety management system or the risk management plan (as applicable).

## 6.10 Runway bearing strength

A runway must be capable of bearing the weights and aircraft movement frequencies of the types of aeroplanes which the runway is nominated to serve.

*Note* As required by paragraph 5.04 (1) (e), the pavement strength rating for a runway must be reported using the ACN – PCN pavement rating system.

## 6.11 Runway shoulders

- (1) For a code D, E or F runway, runway shoulders must be provided.
- (2) For a code D or E runway with a nominated OMGWS of not less than 9 m and up to but not including 15 m — the total width of the runway and the shoulders must not be less than 60 m.
- (3) Subject to subsection (4), a code F runway that has a nominated OMGWS of not less than 9 m and up to but not including 15 m must:
  - (a) be at least 45 m wide; and
  - (b) have at least 7.5 m shoulders on each side;

but only if the engines of an aeroplane for which the runway is nominated would not otherwise overhang the runway shoulders.

*Note* This configuration is normally acceptable for Code F aeroplanes with 2 or 3 engines.

- (4) A code F runway that has a nominated OMGWS of not less than 9 m and up to but not including 15 m must:
- (a) be at least 45 m wide; and
  - (b) have at least 7.5 m **runway shoulders** on each side; and
  - (c) have at least 7.5 m **additional shoulders** on each outer side of the 7.5 m **runway shoulders**;

but only if the engines of an aeroplane for which the runway is nominated would otherwise overhang the **runway shoulders** in the absence of the **additional shoulders**.

*Note* This configuration is normally required for Code F aeroplanes with 4 or more engines.

- (5) Shoulders required by subsection (4) must be provided in the following configuration:
- (a) a 7.5 m width of inner shoulder on each side of the runway capable of supporting any aircraft that runs off the runway;
  - (b) a 7.5 m width of additional shoulder on each outer side of the 7.5 m shoulders mentioned in paragraph (a), that are capable of:
    - (i) resisting engine blast erosion; and
    - (ii) supporting emergency and service vehicles.

*Note* Thus, the total width of the runway and the shoulders must not be less than 75 m.

## 6.12 Characteristics of runway shoulders

Runway shoulders must:

- (a) be of equal width on both sides; and
- (b) slope downwards and away from the runway surface; and
- (c) be resistant to aeroplane engine blast erosion; and
- (d) be capable of supporting an aeroplane running off the runway onto a shoulder without the aeroplane sustaining any structural damage; and
- (e) be capable of supporting emergency and service vehicles; and
- (f) if a taxiway intersects with the runway — merge with the taxiway shoulder (if any); and
- (g) either:
  - (i) preferably be flush to the runway surface; or
  - (ii) if not flush with the runway surface — not step down by more than 25 mm.

## 6.13 Transverse slope on runway shoulder

For design purposes, a transverse slope on a runway shoulder must be within the range of the percentage figures in column 1 in Table 6.13 but a construction tolerance above or below the range is allowed within the limits specified in column 2.

**Table 6.13 Runway shoulder transverse slope values**

Design slope	Construction tolerance
1.0 - 2.5%	± 0.5%

### 6.14 Provision of runway strip

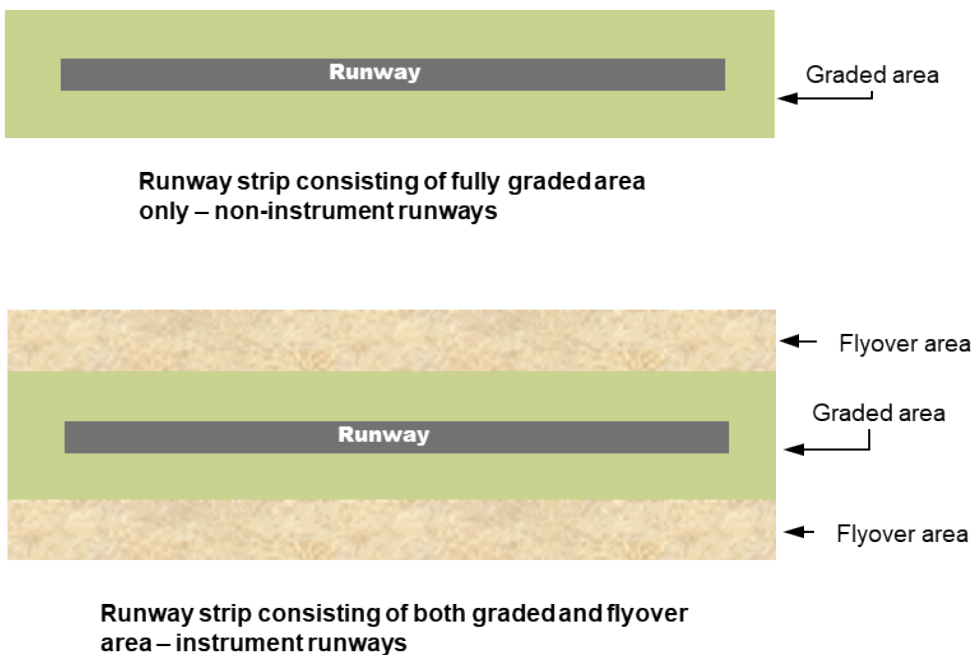
- (1) A runway and each associated stopway must be centrally located within a runway strip.
- (2) If the runway strip is made available for landing and take-off, it must be maintained to the same standard as a natural surface runway in accordance with Table 6.09 (7).

### 6.15 Composition of runway strip

In addition to a runway and associated stopways, a runway strip must also include the following:

- (a) for a non-instrument runway — a graded area around the runway and stopway;
- (b) for an instrument runway:
  - (i) a graded area around the runway and associated stopways; and
  - (ii) an area (*fly-over area*) outside the graded area.

*Note* See the illustrations in Figure 6.15. The runway sits within the graded area.



**Figure 6.15 Composition of runway strip (illustrates matters)**

### 6.16 Runway strip length

The graded area of a runway strip must extend before the threshold, and beyond the end of the runway or any associated stopway, for at least the following distances:

- (a) for a non-instrument code 1 runway — 30 m;
- (b) in any other case — 60 m.

## **6.17 Runway strip width**

- (1) Subject to this section, the width of the graded area of a runway strip must not be less than that shown in Table 6.17 (1).
- (2) In Table 6.17 (1), for a runway with a runway code number mentioned in a row of column 1, the graded runway strip width is the width mentioned in column 2 for the same row.

**Table 6.17 (1) Graded runway strip width**

Runway code number (ARC)	Graded runway strip width
1 <i>Note</i> See also subsection 6.17 (3).	60 m
2	80 m
3 (if the runway width is 30 m)	90 m
3 (if the runway is used for scheduled international air transport operations); or 3 (if the runway width is 45 m or more); or 4	150 m

*Note* For Code 3 runways with a width of 30 m, a 150 m wide graded runway strip is recommended.

- (3) For a code 1 runway that has permanent lighting, the graded runway strip width must not be less than 80 m.
- (4) For a non-precision approach runway — the width of the runway strip, including the fly-over area, must not be less than that shown in Table 6.17 (4).
- (5) In Table 6.17 (4), for a runway with a runway code number mentioned in a row of column 1, the runway strip width, including the fly-over area, is the width mentioned in column 2 for the same row.

**Table 6.17 (4) Runway strip width, including the fly-over area — non-precision approach runways**

Runway Code Number (ARC)	Runway strip width, including the fly-over area
1 or 2	140 m
3 or 4	280 m

- (6) For a precision approach runway — the width of the runway strip, including the fly-over area, must not be less than that shown in Table 6.17 (6).
- (7) In Table 6.17 (6), for a runway with a runway code number mentioned in a row of column 1, the runway strip width, including the fly-over area, is the width mentioned in column 2 for the same row.

**Table 6.17 (6) Runway strip width, including the fly-over area — precision approach runways**

Runway Code Number (ARC)	Runway strip width, including the fly-over area
1 or 2	140 m
3 or 4	280 m

## 6.18 Longitudinal slope on graded area of runway strip

- (1) The design longitudinal slope along the graded area of the runway strip must not exceed:
  - (a) for a code 4 runway — 1.5%; and
  - (b) for a code 3 runway — 1.75%; and
  - (c) for a code 1 or 2 runway — 2.0%.
- (2) The design longitudinal slope values expressed in subsection (1) do not apply at the intersection of a runway strip with another runway strip or a taxiway strip if:
  - (a) there are conflicting drainage requirements or slope requirements; and
  - (b) alternative runway strip longitudinal slope values are as follows:
    - (i) arrived at after a safety analysis using the safety management system and the risk management plan;
    - (ii) as close as practicable to the values expressed in subsection (1);
    - (iii) demonstrably safe for aircraft operations;
    - (iv) recorded in the aerodrome manual.

## 6.19 Longitudinal slope changes on graded area of runway strip

- (1) Longitudinal slope changes on the graded area of a runway strip (*slope changes*) must not exceed 2%.
- (2) The slope changes:
  - (a) must be gradual; and
  - (b) must not be abrupt; and
  - (c) must not involve sudden reversal of slopes.

## 6.20 Radio altimeter operating area

- (1) For precision approach SA CAT I, SA CAT II, CAT II and CAT III runways — there must be no longitudinal slope changes on the portion of the graded area of a runway strip mentioned in subsection (2).
- (2) For subsection (1), the portion is the area, immediately before the threshold, that is 60 m wide, 300 m long, and symmetrical about the centreline (*radio altimeter operating area*).
- (3) Despite subsection (1), if it is physically impossible to avoid a slope change on a radio altimeter operating area, the rate of change between 2 consecutive slopes must not exceed 2% per 30 m (that is, a minimum radius of curvature of 1 500 m).

## 6.21 Runway strip transverse slope

- (1) Subject to subsection (2), the design transverse slope of the graded area of the runway strip must not exceed:
  - (a) for a code 3 or 4 runway — 2.5%; and
  - (b) for a code 1 or 2 runway — 3%.
- (2) For the first 3 m of the graded runway strip:
  - (a) adjacent to the runway edge; or

(b) adjacent to the runway shoulder;

the design transverse slope:

(c) must slope downwards; and

(d) may be up to 5%.

(3) Subject to subsection (4), no portion of the fly-over area of a runway strip, and no object or structure on the fly-over area, may project through a plane that:

(a) starts along each outer side of the graded area; and

(b) has an upward slope away from the graded area of 5%.

*Note* The plane commences from the ground level associated with the edge of the graded area.

(4) Navigational aids for the guidance of aircraft or vehicles may project through the plane described in subsection (3) if approved in writing by CASA under subsection 7.02 (1).

## 6.22 Surface of graded area of runway strips

(1) The surface of a graded runway strip that abuts a runway, a runway shoulder or a stopway must not have any step down from the runway, the runway shoulder or the stopway exceeding 25 mm.

*Note* CASA recommends that within the graded area of the runway strip, constructions such as plinths, runway ends, paved taxiway edges etc. are such as to avoid presenting a non-frangible buried vertical face to aircraft wheels in the runway direction, in soft ground conditions.

(2) Maintenance must ensure that no step up to the runway strip from the runway, the runway shoulder or stopway exceeds 25 mm.

(3) Effective drainage (but not involving open drains) must ensure that water does not pool or pond in the graded area of a runway strip.

*Note* Where deemed necessary for proper drainage, an open-air storm water conveyance is permitted in the *non-graded* portion of a runway strip. However, for such cases, CASA recommends that the storm water conveyance should be placed as far as possible from the runway.

(4) The area of a runway strip at the end of a runway that is at least 30 m from the runway threshold must be constructed in such a way as to resist erosion from jet blast, prop wash or rotor wash so that a landing aeroplane is not endangered by the effects of such erosion on the runway, runway shoulder or stopway edge.

*Note* See sections 6.16 to 6.25 for runway strip standards.

## 6.23 Composition of runway strips

The graded portion of a runway strip must be prepared, constructed and maintained so as to minimise hazards arising from differences in the load-bearing capacity of aeroplanes which the runway is intended to serve, in the event of an aeroplane running off the runway.



## 6.24 Objects or structures on runway strips

*Note* The runway strip forms part of the obstacle restriction area. CASA approval is required for objects, other than approved visual and navigational aids, which are located within the obstacle restriction area. See subsection 7.02 (1).

- (1) A runway strip must be free of fixed objects or structures, other than visual or navigational aids for the guidance of aircraft or vehicles:
  - (a) within 77.5 m of the centreline of a code 4F precision approach CAT I, II or III runway; and
  - (b) within 60 m of the centreline of a code 3 or 4 precision approach CAT I, II or III runway; and
  - (c) within 45 m of the centreline of a code 1 or 2 precision approach CAT I runway.
- (2) Any fixed object or structure permitted to be on the runway strip (including visual or navigational aids) must be of low mass and frangibly mounted.
- (3) When a runway is in use for take-off or landing, no mobile object may be on any part of the graded runway strip.

*Note* For information regarding the siting of equipment and installations on runway strips, see section 19.16.

## 6.25 Runway strip availability

If an aerodrome operator prepares a runway strip and makes it available for take-offs and landings, information to that effect and any associated limitations must be provided to the AIS provider for publication in the AIP.

*Note* For information regarding the provision of glider runway strips, see Division 6 of Chapter 6.

## 6.26 Runway end safety area (RESA)

- (1) Subject to subsections (2) and (3), a runway end safety area (**RESA**) must be:
  - (a) provided at the end of a runway strip; and
  - (b) prepared, constructed and maintained to:
    - (i) protect an aeroplane which undershoots or overruns the runway; and
    - (ii) ensure an aeroplane encounters no hazards if it runs off the runway; and
    - (iii) ensure the movement of ARFFS vehicles is facilitated.
- (2) Subsection (1) does not apply for a code 1 or 2 non-instrument runway.
- (3) Subsection (1) does not apply if CASA, in writing and on application, approves, with or without conditions, an engineering solution designed to ensure the safe deceleration of an aircraft in the event of a runway overrun.
- (4) The minimum length of a RESA is 60 m unless otherwise provided for in Table 6.26 (4).
- (5) In Table 6.26 (4), for a runway with a code number mentioned in a row of column 1:
  - (a) the minimum length of the associated RESA is that mentioned in the same row in column 2; and
  - (b) the preferred length of the associated RESA is that mentioned in the same row in column 3.

**Table 6.26 (4) The minimum length of a RESA**

Runway code number	Minimum length of a RESA	Preferred length of a RESA
1 or 2	60 m	120 m
3 or 4	90 m; or 240 m (if the runway is intended for scheduled international air transport operations)	240 m

- (6) A RESA must, as a minimum, be twice the width of the associated runway.
- (7) The slopes on a RESA must not exceed the following values:
  - (a) for the downward longitudinal slope — 5%;
  - (b) for the transverse slope — 5% upwards or downwards.
- (8) Transitions between different slopes on a RESA must be as gradual as possible.
- (9) No portion of a RESA may project above the approach or take-off climb surfaces of the runway.
- (10) A RESA must be free of fixed objects or structures, other than visual or navigational aids for the guidance of aircraft or vehicles.
- (11) Any fixed object or structure permitted to be on a RESA must be of low mass and frangibly mounted.

*Note* CASA recommends that within the graded area of the runway strip, constructions such as plinths, runway ends, paved taxiway edges etc. should be such as to avoid presenting a buried vertical face to aircraft wheels, in the runway direction in soft ground conditions.

- (12) When a runway is in use for take-off or landing, no mobile object may be on any part of a RESA.

## 6.27 Clearways

A clearway, consisting of an obstruction-free rectangular plane, may be provided at the end of a runway.

*Note* The purpose of a clearway is to allow an aeroplane taking off to make a portion of its initial climb to at least 35 ft (10.7 m) above the ground by the end of the clearway.

## 6.28 Location of clearways

A clearway must start at the end of the TORA.

*Note* The area between the end of the runway and the end of the runway strip is treated as a clearway.

## 6.29 Dimensions of clearways

- (1) The maximum length of any clearway must not exceed half the length of the TORA.
- (2) The width of a clearway must be at least:
  - (a) for a code 3 or 4 runway — 150 m; and
  - (b) for a code 2 runway — 80 m; and

- (c) for a code 1 runway — 60 m.
- (3) A clearway must be at least as wide as the width of the runway strip.

### **6.30 Slopes on clearways**

No portion of the surface below a clearway may project above a plane with an upward slope of 1.25%, the lower limit of which is a horizontal line that:

- (a) is perpendicular to the vertical plane containing the runway centreline; and
- (b) passes through a point located on the runway centreline at the end of the TORA.

### **6.31 Objects or structures on clearways**

- (1) A clearway must be free of fixed or mobile objects or structures, other than visual or navigational aids for the guidance of aircraft or vehicles.
- (2) Any fixed objects or structures permitted to be on the clearway must be of low mass and frangibly mounted.

### **6.32 Stopways**

A stopway on which an aeroplane may be stopped in the event of an abandoned take-off may be provided at the end of a runway.

*Note* A stopway is required to terminate 60 m before the end of the runway strip. See section 6.16.

### **6.33 Dimensions of stopways**

A stopway must be as wide as the width of its associated runway.

### **6.34 Surface of stopways**

A stopway with a sealed surface must have frictional characteristics at least equivalent to those of the associated runway.

### **6.35 Stopway slopes and slope changes**

Slope and slope changes on a stopway must be the same as those for the associated runway, except that:

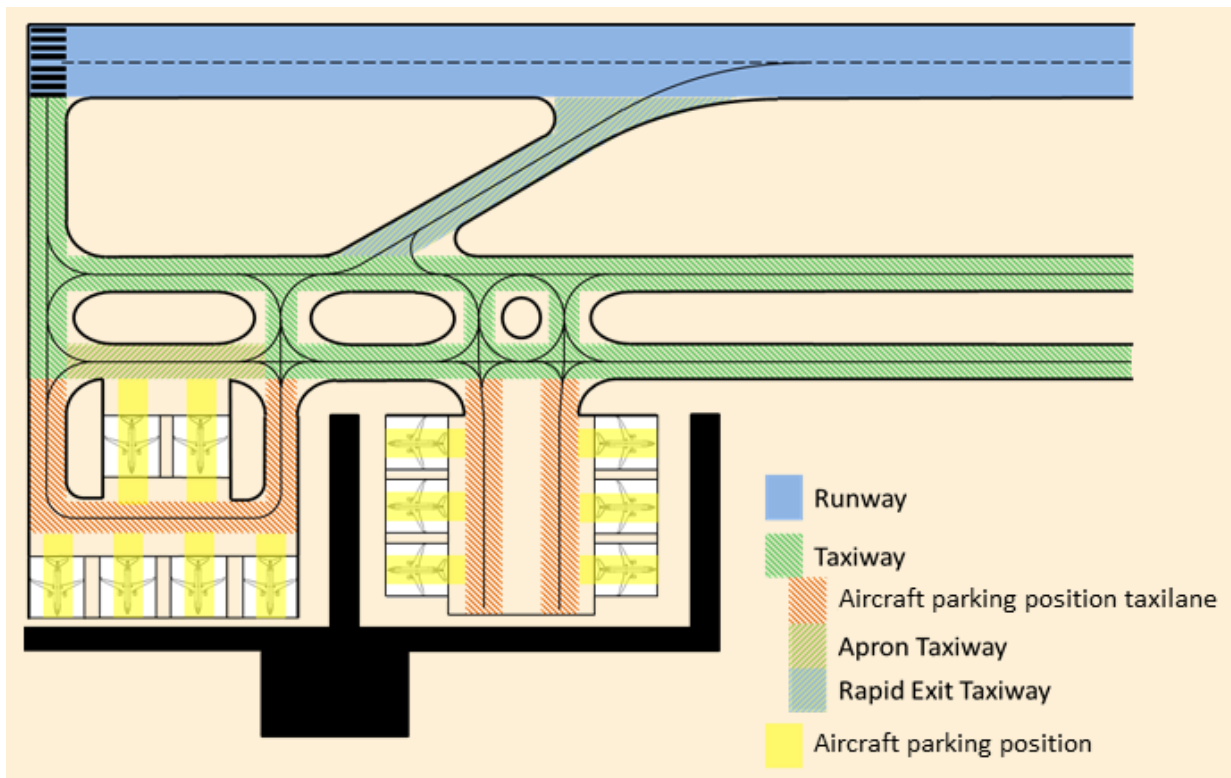
- (a) the limitation of a 0.8% slope for the first and last quarter of the length of a runway do not apply to the stopway; and
- (b) at the junction of the stopway and runway, and along the stopway, the maximum rate of slope change may be increased to 0.3% per 30 m (a minimum radius of curvature of 10 000 m).

### **6.36 Bearing strength of stopways**

The bearing strength of a stopway must be such as to support at least 1 single pass of an aeroplane for which the runway aeroplane reference code nomination is appropriate, without the aeroplane sustaining any structural damage.

## CHAPTER 6

### Division 2 Taxiways



**Figure Division 2 Taxiways (illustrates matters)**

*Note* Figure Division 2 is a colour-coded diagram of runways and the possible layout of taxiways, taxilanes and aircraft stands. It is for illustrative purposes only.

#### 6.37 Taxiway width

- (1) The width of a straight section of a taxiway must not be less than the width determined using Table 6.37 (1).
- (2) In Table 6.37 (1), for a taxiway with the OMGWS mentioned in a row of column 1, the minimum taxiway width of a straight section is the width mentioned in the same row in column 2.

**Table 6.37 (1) Minimum width for straight section of taxiway**

OMGWS	Minimum taxiway width (straight sections)
Up to but not including 4.5 m	7.5 m
4.5 m up to but not including 6 m	10.5 m
6 m up to but not including 9 m	15 m
9 m up to but not including 15 m	23 m

### 6.38 Taxiway edge clearance

- (1) The width of any section of a taxiway must be such that, with the nose wheel of an aeroplane remaining on the taxiway, the clearance between the outer main gear wheels and the edge of the taxiway, at any point, must not be less than the distance determined using Table 6.38 (1).
- (2) In Table 6.38 (1), for a taxiway with an OMGWS mentioned in a row of column 1, the minimum clearance between the outer main gear wheels of an aircraft and the edge of the taxiway is the clearance mentioned in the same row in column 2.

**Table 6.38 (1) Minimum clearance between outer main gear wheels of aircraft and edge of taxiway**

OMGWS	Minimum clearance
Up to but not including 4.5 m	1.5 m
4.5 m up to but not including 6 m	2.25 m
6 m up to but not including 9 m	3 m on straight portions
	3 m on curved portions — for aeroplanes with a wheelbase less than 18 m
	4 m on curved portions — for aeroplanes with a wheelbase equal to or greater than 18 m
9 m up to but not including 15 m	4 m

*Note* Wheelbase means the distance from the nose gear to the geometric centre of the main gear.

### 6.39 Taxiway curves

- (1) The radii of any curves of a taxiway must be compatible with the manoeuvring capability and normal taxiing speeds of the aeroplanes for which the taxiway is provided.

*Note* See ICAO Document 9157, Aerodrome Design Manual, Part 2 — Taxiways and Aprons, for further guidance on the design of the curves. For ICAO documents, see section 1.07.

- (2) The design of a taxiway curve must be such that, when the cockpit of the aeroplane remains over the taxiway centreline markings, the clearance distance between the outer main gear wheels of the aeroplane and the edge of the taxiway is not less than that specified in Table 6.38 (1).

### 6.40 Taxiway longitudinal slope

- (1) The design longitudinal slope along any part of a taxiway must not exceed:
  - (a) for a code C, D, E or F taxiway — 1.5%; and
  - (b) for a code A or B taxiway — 3.0%.
- (2) If it is physically impossible to avoid slope changes along any part of a taxiway, the transition from one longitudinal slope to another must be accomplished by a vertical curve, with a rate of change not more than:
  - (a) for a code C, D, E or F taxiway — 1.0% per 30 m (minimum radius of curvature of 3 000 m); and

- (b) for a code A or B taxiway — 1.0% per 25 m (minimum radius of curvature of 2 500 m).
- (3) The longitudinal slope values expressed in subsections (1) and (2) do not apply at the intersection of a taxiway with a runway or other taxiway if:
  - (a) there are conflicting drainage requirements or slope requirements; and
  - (b) alternative taxiway longitudinal slope values are as follows:
    - (i) arrived at after a safety analysis using the safety management system and the risk management plan;
    - (ii) as close as practicable to values expressed in subsections (1) and (2);
    - (iii) demonstrably safe for aircraft operations;
    - (iv) recorded in the aerodrome manual.

#### 6.41 Taxiway transverse slope

- (1) The transverse slope on any part of a taxiway must not permit any pooling or ponding of water on the taxiway.
- (2) For design purposes, a transverse slope on a taxiway must be within the range of the percentage figures in column 1 in Table 6.41 (2) but a construction tolerance above or below the range is allowed within the limits specified in column 2.

**Table 6.41 (2) Taxiway transverse slope values**

Design slope	Construction tolerance
1.0% - 2.0%	± 0.5%

- (3) The taxiway transverse slope values expressed in Table 6.41 (2) do not apply at the intersection of a taxiway with a runway or another taxiway if:
  - (a) there are conflicting drainage requirements or slope requirements; and
  - (b) alternative taxiway transverse slope values are as follows:
    - (i) arrived at after a safety analysis using the safety management system and the risk management plan;
    - (ii) as close as practicable to values expressed in Table 6.41 (2);
    - (iii) demonstrably safe for aircraft operations;
    - (iv) recorded in the aerodrome manual.

#### 6.42 Taxiway sight distance

- (1) The unobstructed line of sight along the surface of a taxiway, from a point above the taxiway, must not be less than the distance determined using Table 6.42 (1).
- (2) In Table 6.42 (1), for a taxiway with a code letter mentioned in a row of column 1, the minimum unobstructed line of sight along the surface of the taxiway must not be less than the distance mentioned in the same row of column 2.

**Table 6.42 (1) Taxiway line of sight**

Taxiway code letter	Minimum line of sight
A	150 m — from a point 1.5 m above taxiway
B	200 m — from a point 2 m above taxiway
C, D, E or F	300 m — from a point 3 m above taxiway

### 6.43 Taxiway bearing strength

The bearing strength of a taxiway must be:

- (a) at least equal to the bearing strength of the runway it serves; or
- (b) otherwise capable of bearing the weights and movement frequencies of the types of aeroplanes which the taxiway serves.

### 6.44 Taxiway shoulders

A code C, D, E or F taxiway must have shoulders if it is available for use by turbine-engined aeroplanes.

*Note* Taxiway shoulders are otherwise optional but are recommended.

### 6.45 Width of taxiway shoulders

- (1) The total width of the taxiway and the shoulders must not be less than the following (the *minimum taxiway shoulder width*):
  - (a) for a code F taxiway — 44 m;
  - (b) for a code E taxiway — 38 m;
  - (c) for a code D taxiway — 34 m;
  - (d) for a code C taxiway — 25 m.
- (2) The minimum taxiway shoulder width must be maintained along the whole length of a taxiway, including:
  - (a) on its curved sections; and
  - (b) at junctions and intersections with runways and other taxiways.

*Note* The requirement in subsection (1) applies despite any increase in the surface width of the taxiway itself on its curved sections, or at junctions or intersections with runways or other taxiways.

### 6.46 Surface of taxiway shoulders

- (1) Taxiway shoulders must:
  - (a) be on both sides of the taxiway; and
  - (b) slope downwards and away from the taxiway surface; and
  - (c) be resistant to aeroplane engine blast erosion; and
  - (d) if they have a step down from the taxiway surface — not step down by more than 25 mm; and

(e) if a runway intersects with the taxiway — merge with the runway shoulder.

*Note* CASA recommends that a taxiway shoulder should also be capable of the following:

- (a) supporting an aeroplane running off the taxiway onto a shoulder without the aeroplane sustaining any structural damage;
- (b) supporting emergency and service vehicles.

(2) If a sealed taxiway is designed for a jet engine aircraft whose engines overhang the taxiway shoulders, the surface of the shoulders must be sealed along their length to a width of at least 3 m from each taxiway edge.

## 6.47 Taxiway strips

(1) A taxiway, other than an aeroplane taxiway, must be located on a taxiway strip which includes graded areas on either side of the taxiway.

*Note* See Figure 6.47 (1). The taxiway sits within the graded area and overall taxiway strip.

- (2) The surface of the graded area of a taxiway strip where it abuts a taxiway or a taxiway shoulder must not have any step down from the taxiway or a taxiway shoulder exceeding 25 mm.
- (3) Any step up to the taxiway strip from a taxiway or taxiway shoulder must not exceed 25 mm.



**Figure 6.47 (1) Taxiway composition (illustrates matters)**

## 6.48 Width of taxiway strip

The width of the taxiway strip:

- (a) on each side of the centreline of the taxiway; and
  - (b) measured from the centreline; and
  - (c) along the full length of the taxiway;
- must not be less than the following:
- (d) for a code F taxiway — 51 m;



- (e) for a code E taxiway — 43.5 m;
- (f) for a code D taxiway — 37 m;
- (g) for a code C taxiway — 26 m;
- (h) for a code B taxiway — 20 m;
- (i) for a code A taxiway — 15.5 m.

#### 6.49 Width of graded area of taxiway strip

The graded area of a taxiway strip:

- (a) on each side of the taxiway, including shoulders; and
- (b) measured from the centreline of the taxiway; and
- (c) along the full length of the taxiway;

must not be less than the following:

- (d) for a taxiway where the OMGWS is less than 4.5 m — 10.25 m;
- (e) for a taxiway where the OMGWS is at least 4.5 m but less than 6 m — 11 m;
- (f) for a taxiway where the OMGWS is at least 6 m but less than 9 m — 12.5 m;
- (g) for a taxiway where the OMGWS is at least 9 m but less than 15 m — 18.5 m where the code letter is D;
- (h) for a taxiway where the OMGWS is at least 9 m but less than 15 m — 19 m where the code letter is E;
- (i) for a taxiway where the OMGWS is at least 9 m but less than 15 m — 22 m where the code letter is F.

#### 6.50 Slope of taxiway strip

- (1) The graded area of a taxiway strip, when measured relative to the transverse slope of the adjacent taxiway surface, must not have a design upward transverse slope that is more than:
  - (a) for a code C, D, E or F taxiway — 2.5%; or
  - (b) for a code A or B taxiway — 3%.
- (2) The graded area of a taxiway strip, when measured relative to the horizontal, must not have a design downward transverse slope that exceeds 5.0%.
- (3) No part of the taxiway strip beyond the graded area, and no objects or structures on the taxiway strip beyond the graded area, may project upwards through the plane surface mentioned in subsection (4).
- (4) For subsection (3), the plane surface originates from the outer edge of the graded taxiway strip, and slopes upwards and outwards at a slope of 5% measured relative to the horizontal.

*Note 1* The plane commences from the level associated with the edge of the graded area.

*Note 2* Drains and ditches may be located at ground level in the taxiway strip beyond the graded portion.

#### 6.51 Objects or structures on a taxiway strip

- (1) A taxiway strip must be free of fixed objects or structures other than visual or navigational aids used for the guidance of aircraft or vehicles.

- (2) Visual aids located within a taxiway strip must be sited at such a height that they cannot be struck by the propellers, engine pods or wings of aircraft using the taxiway.

### 6.52 Taxiways on bridges

- (1) A bridge that is for a taxiway, or the part of a bridge that is to carry a taxiway (***taxiway bridge***) must be designed and constructed to bear the weight and frequency of the aircraft traffic for which the taxiway has the appropriate ARC nomination.
- (2) The minimum width of a taxiway bridge must not be less than the total width of the taxiway and the graded areas specified in section 6.49.
- (3) Despite subsection (2), the minimum width of the taxiway bridge may be reduced to not less than the width of the associated taxiway specified in section 6.37 if lateral restraints are provided at each edge of the taxiway bridge to prevent an aircraft from leaving the taxiway bridge.
- (4) For subsection (3), a lateral restraint must not be hazardous for any aeroplane for which the taxiway is intended.
- (5) If the engines of an aeroplane for which the taxiway has the appropriate ARC nominated overhang the structure of the taxiway bridge, adjacent areas below the taxiway bridge must be protected in such a way that no person or property is injured, damaged or adversely affected by engine blast.
- (6) Vehicle access roads for emergency purposes may be located alongside a taxiway bridge.
- (7) Vehicles on the access roads, and any required lateral restraints for vehicles, may infringe the slope of 5% measured relative to the horizontal mentioned in subsection 6.50 (4).

### 6.53 Taxiway minimum separation distances

- (1) The separation distance between the centreline of a taxiway (including an apron taxiway, a rapid exit taxiway, and a taxilane) and 1 of the following:
  - (a) the centreline of a parallel runway;
  - (b) the centreline of a parallel taxiway;
  - (c) the centreline of a parallel taxilane;
  - (d) a building, structure, vehicle, wall, plant, equipment, parked aeroplane or road;must not be less than the distance determined using Tables 6.53 (1)-1 and 6.53 (1)-2.
- (2) For Table 6.53 (1)-1, where the row for a nominated code number for a runway (***the runway***) intersects with the column for a nominated code letter for the taxiway, the distance mentioned in the intersecting cell is the minimum separation distance required for the centreline of an associated taxiway to be from the centreline of the runway.
- (3) The separation distance of the following (***the relevant minimum separation distance***):
  - (a) from the centreline of a taxiway (other than a taxilane) to the centreline of another taxiway (including a taxilane);
  - (b) from the centreline of a taxiway (other than a taxilane) to an object or structure;
  - (c) from the centreline of a taxilane to the centreline of another taxilane;
  - (d) from the centreline of a taxilane to an object, structure, parked aeroplane or road;must not be less than the distance determined using Table 6.53 (1)-2.

- (4) For Rows 1 and 2 in Table 6.53 (1)-2, the relevant minimum separation distance for a taxiway with a code letter mentioned in a column of the Row is the distance in metres mentioned in the same column of the Row.
- (5) For Rows 3 and 4 in Table 6.53 (1)-2, the relevant minimum separation distance for a taxilane with a code letter mentioned in a column of the Row is the distance in metres mentioned in the same column of the Row.

**Table 6.53 (1)-1 Taxiway minimum separation distance to runways**

<b>From a taxiway centreline to a precision approach runway centreline</b>						
	<b>Code letter (Column 2)</b>					
<b>Runway code number (Column 1)</b>	<b>A</b>	<b>B</b>	<b>C</b>	<b>D</b>	<b>E</b>	<b>F</b>
1	77.5 m	82 m	88 m	–	–	–
2	77.5 m	82 m	88 m	–	–	–
3	152 m	152 m	158 m	166 m	172.5 m	180 m
4	–	–	158 m	166 m	172.5 m	180 m
<b>From a taxiway centreline to a non-precision approach runway centreline</b>						
	<b>Code letter (Column 2)</b>					
<b>Runway code number (Column 1)</b>	<b>A</b>	<b>B</b>	<b>C</b>	<b>D</b>	<b>E</b>	<b>F</b>
1	77.5 m	82 m	88 m	–	–	–
2	77.5 m	82 m	88 m	–	–	–
3	152 m	152 m	158 m	166 m	172.5 m	180 m
4	–	–	158 m	166 m	172.5 m	180 m
<b>From a taxiway centreline to a non-instrument runway centreline</b>						
	<b>Code letter (Column 2)</b>					
<b>Runway code number (Column 1)</b>	<b>A</b>	<b>B</b>	<b>C</b>	<b>D</b>	<b>E</b>	<b>F</b>
1	37.5 m	42 m	48 m	–	–	–
2	47.5 m	52 m	58 m	–	–	–
3	52.5 m	87 m	93 m	101 m	107.5 m	115 m
4	–	–	93 m	101 m	107.5 m	115 m

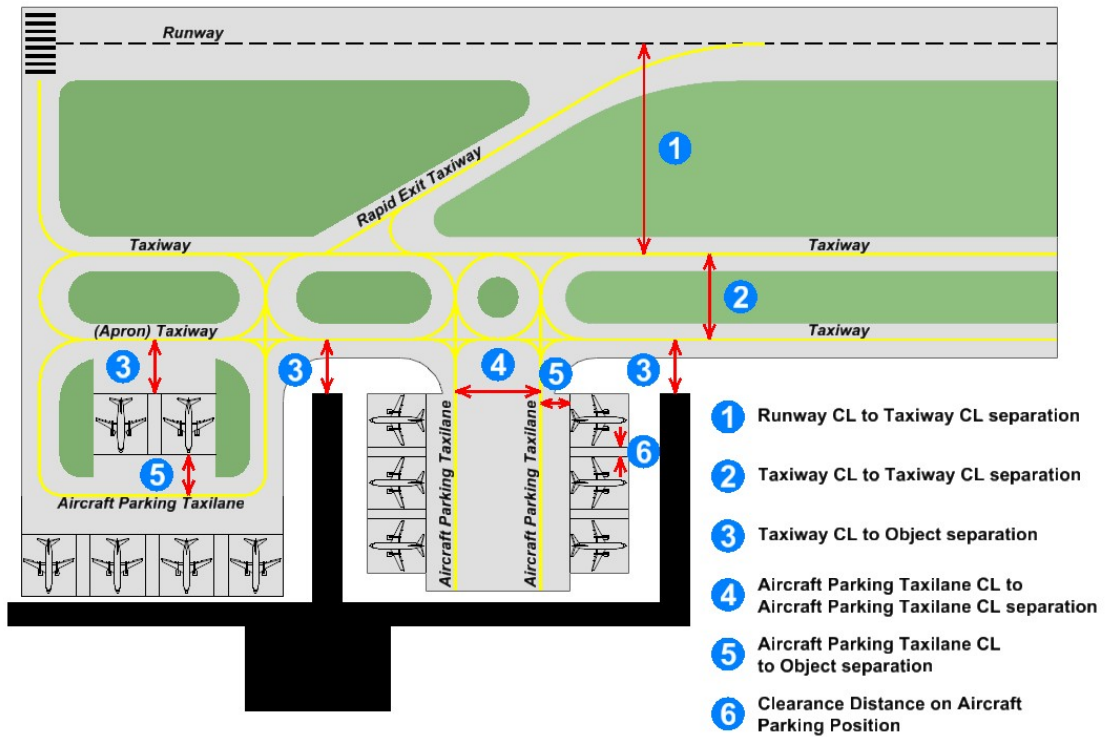
**Table 6.53 (1)-2 Taxiway and taxilane minimum separation distance to other taxiways, taxilanes, objects, structures, parked aeroplanes or roads**

<b>From a taxiway centreline, other than a taxilane, to another taxiway centreline</b>						
<b>Row 1</b>	<b>Code letter</b>					
	<b>Column 1</b>	<b>Column 2</b>	<b>Column 3</b>	<b>Column 4</b>	<b>Column 5</b>	<b>Column 6</b>
	<b>A</b>	<b>B</b>	<b>C</b>	<b>D</b>	<b>E</b>	<b>F</b>
	23 m	32 m	44 m	63 m	76 m	91 m
<b>From a taxiway centreline, other than a taxilane, to an object, structure, parked aeroplane or road</b>						
<b>Row 2</b>	<b>Code letter</b>					
	<b>Column 1</b>	<b>Column 2</b>	<b>Column 3</b>	<b>Column 4</b>	<b>Column 5</b>	<b>Column 6</b>
	<b>A</b>	<b>B</b>	<b>C</b>	<b>D</b>	<b>E</b>	<b>F</b>
	15.5 m	20 m	26 m	37 m	43.5 m	51 m
<b>From a taxilane centreline to another taxilane centreline</b>						
<b>Row 3</b>	<b>Code letter</b>					
	<b>Column 1</b>	<b>Column 2</b>	<b>Column 3</b>	<b>Column 4</b>	<b>Column 5</b>	<b>Column 6</b>
	<b>A</b>	<b>B</b>	<b>C</b>	<b>D</b>	<b>E</b>	<b>F</b>
	19.5 m	28.5 m	40.5 m	59.5 m	72.5 m	87.5 m
<b>From a taxilane centreline to an object, structure, parked aeroplane or road</b>						
<b>Row 4</b>	<b>Code letter</b>					
	<b>Column 1</b>	<b>Column 2</b>	<b>Column 3</b>	<b>Column 4</b>	<b>Column 5</b>	<b>Column 6</b>
	<b>A</b>	<b>B</b>	<b>C</b>	<b>D</b>	<b>E</b>	<b>F</b>
	12 m	16.5 m	22.5 m	33.5 m	40 m	47.5 m

*Note 1* Separation distances are based on the concept of the wing of an aeroplane, centred on a parallel taxiway, remaining clear of a runway strip of standard width.

*Note 2* The taxiway centreline to runway centreline separation distances in Table 6.53 (1)-2 have been determined using the maximum runway strip width required for the particular operational category (whether precision, non-precision or non-instrument) and the runway code letter.

*Note 3* ILS installations may influence the location of taxiways due to interference to ILS signals from a taxiing or stopped aircraft. Information on critical and sensitive areas surrounding ILS installations is contained in ICAO Annex 10, Aeronautical Telecommunications, Volume I, Radio Navigation Aids, Attachment C. Further information may be obtained by consulting the CNS facility service provider. For ICAO documents, see section 1.07.



**Figure 6.53 (1) Certain separation distances (illustrates matters)**

*Note* Figure 6.53 (1) is a diagram showing certain separation distances. It is for illustrative purposes only. In the legend, *CL* means centreline.

## CHAPTER 6

### Division 3 Holding bays, runway holding positions, intermediate holding positions and road-holding positions

#### 6.54 Provision of a holding bay, runway holding position, intermediate holding position and road-holding position

*Note* Holding bays may allow more than 1 aircraft to hold in proximity to a runway entry or allow for the passing of aircraft on a taxiway. However, these areas are not for aircraft parking purposes.

- (1) A runway holding position must be established:
  - (a) for a taxiway that intersects with a runway — at the intersection; and
  - (b) for a taxiway location, other than at the intersection of the taxiway and a runway — where a taxiing aircraft or vehicle would otherwise infringe an obstacle limitation surface or interfere with the operation of radio navigation aids; and
  - (c) at an intersection of a runway with another runway — where an aeroplane is required to hold.
- (2) Except for an exit taxiway, an intermediate holding position must be established on a taxiway if ATC requires an aeroplane to hold at that position or those positions.
- (3) A road-holding position must be established at an intersection of a road with a runway.

*Note* See section 8.91 of this MOS for signage and marking of a road-holding position.

#### 6.55 Location of a holding bay, runway holding position, intermediate holding position or road-holding position

- (1) A holding bay, runway holding position, intermediate holding position or road-holding position must not be placed where an aircraft or vehicle using the position would:
  - (a) infringe the obstacle free zone, the approach surface, the take-off climb surface or the graded area of the runway strip; or
  - (b) interfere with the operation of radio navigation aids.
- (2) A holding bay must be designed to ensure that all aircraft types within the nominated code letter for the holding bay are separated from aircraft on the associated taxiway by at least the width of the relevant taxiway strip specified in section 6.48.

#### 6.56 Distance from runway holding position, intermediate holding position or road-holding position, to runway centreline

- (1) A runway holding position, holding bay, intermediate holding position, or road-holding position must not be located closer to the centreline of the runway than the distance (the *relevant distance*) determined using Table 6.56 (1).
- (2) In Table 6.56 (1):
  - (a) for a runway with a code number mentioned in a row in column 1, the relevant distance for a type of runway mentioned in column 2 is the distance shown in the cell for the type of runway that is in the same row; and

(b) if a distance shown in a cell in accordance with paragraph (a) has a superscribed letter of the alphabet corresponding to the same letter in Note 1 in the Table:

(i) the text in Notes 1 and 2 for the letter has the same legal force as if it appeared in this subsection; and

(ii) the relevant distance may be modified according to the text in the Note.

**Table 6.56 (1) Minimum distance from runway holding position, intermediate holding position or road-holding position, to associated runway centreline**

Runway code number (Column 1)	Type of runway (Column 2)				
	Non-instrument	Non-precision approach	Precision CAT I	Precision CAT II or CAT III	Take-off
1	30 m	40 m	60 m <sup>d</sup>		30 m
2	40 m	40 m	60 m <sup>d</sup>		40 m
3	75 m <sup>a</sup>	75 m <sup>a</sup>	90 m <sup>b, d</sup>	90 m <sup>d</sup>	75 m <sup>a</sup>
4	75 m	75 m	90 m <sup>c, d</sup>	90 m <sup>c, d</sup>	75 m

*Note 1*

<sup>a</sup> If the runway code is A or B, the minimum distance is 45 m.

<sup>b</sup> If the runway code is A or B, the minimum distance is 75 m.

<sup>c</sup> If the runway code is F, the minimum distance is 107.5 m.

*Note 2* For “d”, this distance must be increased, if necessary, to the distance that ensures the avoidance of interference with radio navigation aids. Advice on ILS critical and sensitive areas must be obtained from the relevant aeronautical telecommunications service and radio navigation service provider.

(3) Despite subsection (1), for a holding bay, runway or road-holding position, the relevant distance mentioned in Table 6.56 (1) may be decreased by 5 m for every 1 m that the elevation of the bay or position is lower than the runway threshold elevation, provided that an aircraft at the bay or position does not infringe on the inner transitional surface.

## CHAPTER 6

### Division 4 Aprons

#### 6.57 Location of apron

An apron must be located so that an aeroplane parked on it does not infringe an obstacle limitation surface.

#### 6.58 Separation distances on aprons

- (1) An aircraft entering or exiting a parking position must be separated from an object, structure or parked aeroplane by a *separation distance* not less than that determined using Table 6.58 (1).

*Note* The separation distance is based on the minimum distance between the wingtip of an aeroplane on the aircraft parking position and the object or structure.

- (2) In Table 6.58 (1):
- (a) for an aircraft entering or exiting a parking position with a code letter mentioned in a row of column 1, the separation distance of the aircraft from an object, structure or parked aeroplane must not be less than the distance shown in column 2 in the same row; and
  - (b) if a distance shown in a row in column 2 has a superscribed asterisk explained in the Note in the Table:
    - (i) the text in the Note for the asterisk has the same legal force as if it appeared in this subsection; and
    - (ii) the relevant separation distance must be modified according to the text in the Note.

**Table 6.58 (1) Aircraft parking positions — minimum separation distance**

<b>Aircraft parking position code letter</b>	<b>Separation distance for an aircraft from an object, structure or parked aeroplane</b>
A	3.0 m
B	3.0 m
C	4.5 m
D	7.5 m
E	7.5 m*
F	7.5 m*
<i>Note</i> * The minimum separation distance must be 10 m if free-moving parking is used.	

- (3) An aircraft parked on an aircraft parking position must be separated from any object or structure, other than an aerobridge, by a distance not less than that determined using Table 6.58 (1).



- (4) Subsection (1) does not apply to a code D, E or F parking position if:
  - (a) the aerodrome operator's written safety assessment demonstrates that a VDGS allows a reduced separation distance without creating risk of damage to the aeroplane; and
  - (b) the safety assessment and the reduced separation distance are recorded in the aerodrome manual.

## **6.59 Alternative aircraft parking position separation**

- (1) If:
  - (a) physical constraints prevent an aircraft parking position (the *position*) from complying with the separation distances under section 6.58; and
  - (b) the aerodrome operator:
    - (i) designs a position in accordance with Part 2 of ICAO Document 9157, Aerodrome Design Manual — Taxiways and Aprons; and
    - (ii) submits the design to CASA with a written safety assessment and an application for approval; and
  - (c) CASA, in writing, with or without conditions, approves the safety assessment;then:
  - (d) such of the standards in section 6.58 as are specified in the CASA approval as non-applicable, are taken not to apply to the operator; and
  - (e) the approved design and safety assessment, the conditions of the approval (if any), and the alternative standards specified in the CASA approval are taken to be the applicable standards for the positions.

*Note* For ICAO documents, see section 1.07.

## **6.60 Slopes on aprons**

- (1) The design slope on a parking position must:
  - (a) if the parking position is sealed — not exceed 1%; and
  - (b) if the parking position is a natural surface — not exceed 2%.
- (2) The design slopes on apron taxiways, including taxiway strips and taxilanes, must be determined in accordance with Chapter 6, Division 2, Taxiways, as if the apron taxiway were a taxiway.
- (3) The design slope on any part of any apron that is not a taxiway or a taxilane must:
  - (a) be level as far as possible without causing water to pool or pond on the surface of the apron; and
  - (b) not vary more than 2% from the horizontal.
- (4) The slopes on the following:
  - (a) an apron, that is not an apron taxiway or taxilane;
  - (b) an apron which is part of a parking position;must transition smoothly to the maximum allowable slope on the corresponding parking position.

- (5) Subject to subsection (6), the grading of an apron must be such that it does not slope down towards the terminal building.
- (6) If a slope down towards a terminal building cannot physically be avoided, apron drainage must direct any spilled fuel away from the building and other structures adjoining the apron.
- (7) If a stormwater drain collects spilt fuel from the apron area, flame traps or interceptor pits must be provided to isolate the fuel and prevent it spreading from the apron area.

### **6.61 Apron bearing strength**

Each part of an apron must be capable of withstanding the traffic of the aircraft for which it is designed.

*Note* This is to prevent the development of surface depressions or other hazards which may adversely affect aircraft operations.

### **6.62 Apron roads**

A marked vehicle roadway on an apron must not bring a vehicle closer than 3 m horizontally to any part of an aircraft on an aircraft parking position.

## CHAPTER 6

### Division 5 Blast and wash from aircraft propulsion systems

#### 6.63 General

Movement area design must protect the following from any damaging or injurious effects of jet blast, rotor wash and propeller wash:

- (a) people;
- (b) other aircraft;
- (c) buildings;
- (d) vehicles;
- (e) equipment.

*Note* People and property are not to be exposed to the dangers of high speed, high temperature airflows from blast and wash sources.

#### 6.64 Jet blast, propeller wash and rotor wash air velocity

For section 6.63, the maximum blast or wash velocity is as follows:

- (a) 60 km/h:
  - (i) for areas of an aerodrome traversed by flight crew, or passengers, boarding or leaving an aircraft; or
  - (ii) for public areas, within or outside the aerodrome boundary, where passengers or members of the public are likely to walk or congregate;
- (b) 80 km/h — for public areas where passengers or others are not likely to congregate;
- (c) 50 km/h — for public roads where the vehicle speed is likely to be 80 km/h or more;
- (d) 60 km/h — for public roads where the vehicle speed is likely to be less than 80 km/h;
- (e) 80 km/h — for any personnel working near an aeroplane;
- (f) 80 km/h — for equipment on an apron;
- (g) 60 km/h — for light aeroplane parking areas with some risk of damage;
- (h) 80 km/h — for light aeroplane parking areas with zero risk of damage;
- (i) 100 km/h — for buildings and other structures.

*Note* An aerodrome operator may use jet blast fences, appropriate building materials or other effective means to achieve the standards.

## CHAPTER 6

### Division 6 Glider facilities

*Note* The provision of glider facilities at an aerodrome is a decision for the aerodrome operator. If glider facilities are provided, CASA recommends that the aerodrome operator consults the operators of both powered aircraft and gliders to ensure that the provision of glider facilities is adequate.

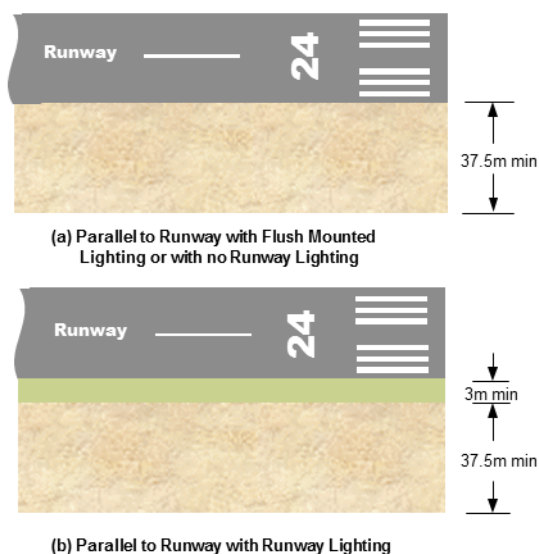
#### 6.65 General

If glider facilities, including parking and staging areas, are provided, they must:

- (a) meet the minimum dimensions required under section 6.66; and
- (b) be correctly marked in accordance with section 8.126; and
- (c) have their presence and status at the aerodrome reported in accordance with Division 1 of Chapter 5.

#### 6.66 Dimensions of glider runway strips

- (1) If a glider runway strip is located anywhere outside an existing runway strip, the width of the glider runway strip must not be less than 60 m.
- (2) The separation distance between the centrelines of a glider runway strip and a parallel runway must be not be less than 120 m for an aerodrome with:
  - (a) an approved glider circuit direction contrary to the aerodrome circuit pattern; and
  - (b) glider operations conducted independently of parallel runway operations.
- (3) If a glider runway strip is located wholly or partly within the runway strip of an existing runway:
  - (a) the width of the glider runway strip must not be less than 37.5 m, measured:
    - (i) if there is no existing runway lighting, or the existing runway lighting is flush with the runway — from the runway edge; and  
*Note* See Figure 6.66 (3).
    - (ii) if there are hazards to glider operations from elevated or other features of the existing runway — from 3 m clear of the hazards.



**Figure 6.66 (3) Glider runway strip (illustrates matters)**

*Note* Standards for the marking of glider runway strips can be found in Chapter 8, Division 13.

### 6.67 Glider parking areas

A glider parking area must not be located inside the glider runway strip or the existing runway strip.

### 6.68 Glider runway strip standards

- (1) A glider runway strip located inside an existing runway strip for powered aircraft must comply with the standards in this MOS for a runway strip.
- (2) A glider runway strip located outside an existing runway strip for powered aircraft must comply with the standards for a code A runway and a code 1 obstacle limitation surface.

## CHAPTER 7 OBSTACLE RESTRICTION AND LIMITATION

### Division 1 General

#### 7.01 Introduction

- (1) Both of the following must be monitored and maintained free from obstacles in accordance with this MOS:
  - (a) the airspace around an aerodrome;
  - (b) the manoeuvring area of an aerodrome.

*Note 1* Where the requirement to maintain the OLS and PANS-OPS airspace (protection surface) clear of obstacles cannot be fulfilled, some kinds of aerodrome operation may not be authorised or permitted.

*Note 2* An aerodrome operator is responsible for monitoring the OLS and PANS-OPS airspace and must advise CASA in the event of an actual or proposed OLS penetration, and the terminal instrument flight procedure designer in the event of an actual or proposed penetration into the PANS-OPS airspace. Following CASA or designer assessment of any resulting hazard from the penetration, it is the responsibility of the aerodrome operator to advise the relevant planning authority of the result of the assessment and liaise with that authority to ensure that hazardous obstacles that are an unacceptable risk to aviation are not approved; or that hazardous objects or structures are appropriately mitigated, for example, through charting, markings or lighting.

*Note 3* Obstacles within the aerodrome boundary are to be dealt with in accordance with section 7.03. To address obstacles either outside of the aerodrome boundary or otherwise outside of the control of the aerodrome operator, may require liaison with the relevant planning authority.

- (2) Obstacle data requirements for terminal instrument flight procedure design must be determined by a certified designer under Part 173 of CASR.

#### 7.02 Obstacle restriction area

- (1) Objects or structures, other than approved visual and navigational aids, must not be constructed or erected within the obstacle restriction area of an aerodrome without the written approval of CASA.
- (2) Equipment and installations required for air navigation must be:
  - (a) of minimum possible mass and height; and
  - (b) frangible, including any mountings; and
  - (c) sited to reduce to a minimum any hazard they may present to aircraft.
- (3) In determining the obstacle clear approach or take-off surfaces, obstacles in the obstacle restriction area must be taken into account.

## CHAPTER 7

### Division 2 Obstacle limitation surfaces (OLS)

#### 7.03 Introduction

- (1) An aerodrome operator must establish and monitor the obstacle limitation surfaces (*OLS*) applicable to the aerodrome.
- (2) The physical dimensions of the OLS for approach runways must be determined using Table 7.15 (1).
- (3) The physical dimensions of the OLS for take-off runways must be determined using Table 7.16 (1).
- (4) As far as possible, the aerodrome operator must ensure that the OLS within the aerodrome boundary is maintained clear of obstacles.

*Note* If third parties propose to erect structures likely to infringe the OLS *outside the aerodrome boundary*, it is in the interests of aerodrome operators to liaise as soon as possible with the proponents and the relevant planning authorities, with a view to ensuring the preservation of the OLS and limiting the introduction of new obstacles.

#### 7.04 Reference elevation datum

A reference elevation datum must be:

- (a) established for the horizontal and conical surfaces of the OLS; and
- (b) if the elevation of the ARP is within 3 m of the average elevations of all existing and proposed runway ends — the same elevation as the ARP (rounded down to the nearest half metre); and
- (c) if paragraph (b) does not apply — the average elevation of existing and proposed runway ends (rounded down to the nearest half metre).

*Note* The reference elevation datum is not to be confused with the aerodrome elevation published in the AIP-ERSA. Aerodrome elevation is, by definition, the highest point on the landing area.

#### 7.05 Outer horizontal surface of the OLS

The outer horizontal surface of the OLS must consist of a plane located 150 m above the reference elevation datum and extending from the upper edge of the extended conical surface, for a radial distance of 15 000 m from the ARP.

*Note* For guidance only, Figure 7.07-1 shows the relationship between the outer horizontal, the conical, the inner horizontal, and the transitional surfaces.

#### 7.06 Conical surface

- (1) The conical surface of the OLS must consist of straight and curved elements which slope upwards and outwards from the edge of the inner horizontal surface to the relevant height specified in Table 7.15 (1) above the inner horizontal surface.

*Note* For guidance only, see Figure 7.07-1.

- (2) The slope of the conical surface must be measured in a vertical plane perpendicular to the periphery of the inner horizontal surface.

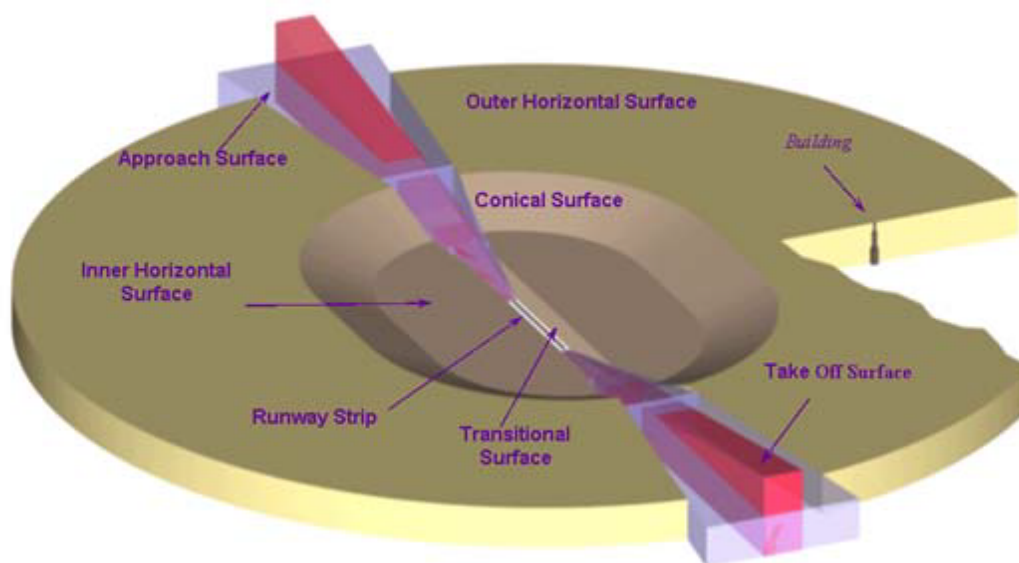
- (3) If an outer horizontal surface is present and the end of the conical surface does not terminate directly into the commencement of the outer horizontal surface, the conical surface must then continue outwards on the same plane perpendicular to the periphery of the inner horizontal surface until it reaches the commencement of the outer horizontal surface.

## 7.07 Inner horizontal surface

The inner horizontal surface must be a horizontal plane, at the height specified in Table 7.15 (1) above the reference elevation datum, and extending to an outer boundary comprising:

- (a) in the case of an aerodrome with a single runway — semi-circular curves of a radius determined in accordance with Table 7.15 (1), centred on the middle of each of the runway strip ends and joined tangentially by straight lines on each side of the runway parallel to the runway centreline; and
- (b) in the case of an aerodrome with multiple runways — curves of a specified radius, centred on the middle of each of the runway strip ends and joined by a tangential line as 2 curves intersect.

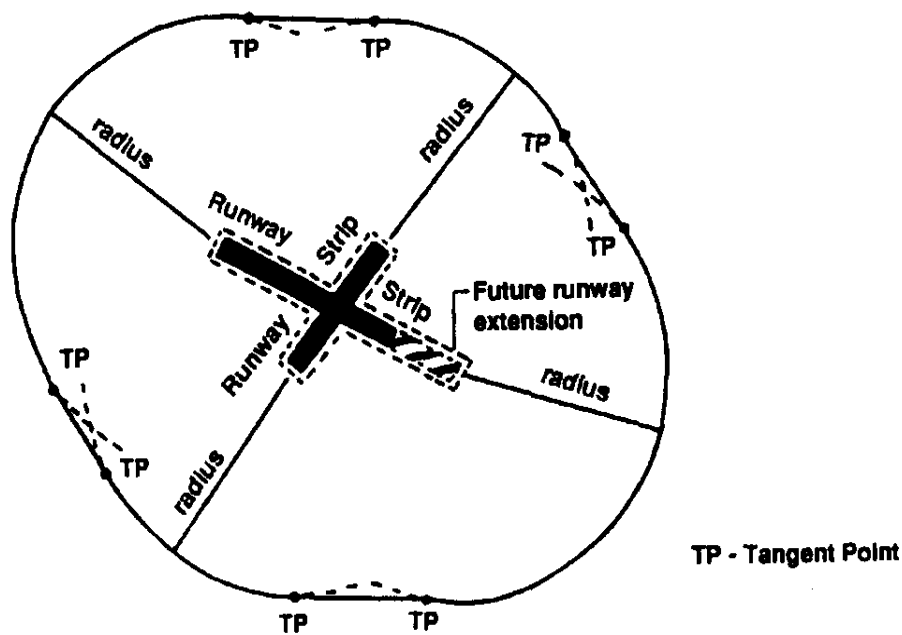
*Note* For guidance only, see Figure 7.07-2.



**Figure 7.07-1 Relationship of outer horizontal, conical, inner horizontal and transitional surfaces, with an example obstacle (illustrates matters)**



Outer edge of Inner Horizontal and Inner edge of Conical



TP - Tangent Point

Figure 7.07-2 Boundary of inner horizontal surface (illustrates matters)

## 7.08 Approach surface

- (1) The approach surface must be an inclined plane, or combination of planes, which originates from the inner edge associated with each runway threshold, with 2 sides originating at the ends of the inner edge.
- (2) The inner edge associated with each runway threshold must have a specified length, and be located horizontally and perpendicular to the runway centreline, at the relevant distance before the threshold, as specified in Table 7.15 (1).
- (3) The 2 sides must diverge uniformly from the extended centreline of the runway at the relevant rate, as specified in Table 7.15 (1).
- (4) The approach surface may be divided into 3 sections and ends at an outer edge that is located at the relevant overall distance from the inner edge, and parallel to the inner edge, as specified in Table 7.15 (1).
- (5) The elevation of the midpoint of the threshold must be the elevation of the inner edge.
- (6) The slope of each section of the approach surface must be as specified in Table 7.15 (1) measured in the vertical plane containing the centreline of the runway.

*Note* For guidance only, see Figures 7.08 (6)-1 and 7.08 (6)-2 for the approach surface for an instrument approach runway, and a plane view of the approach surface.

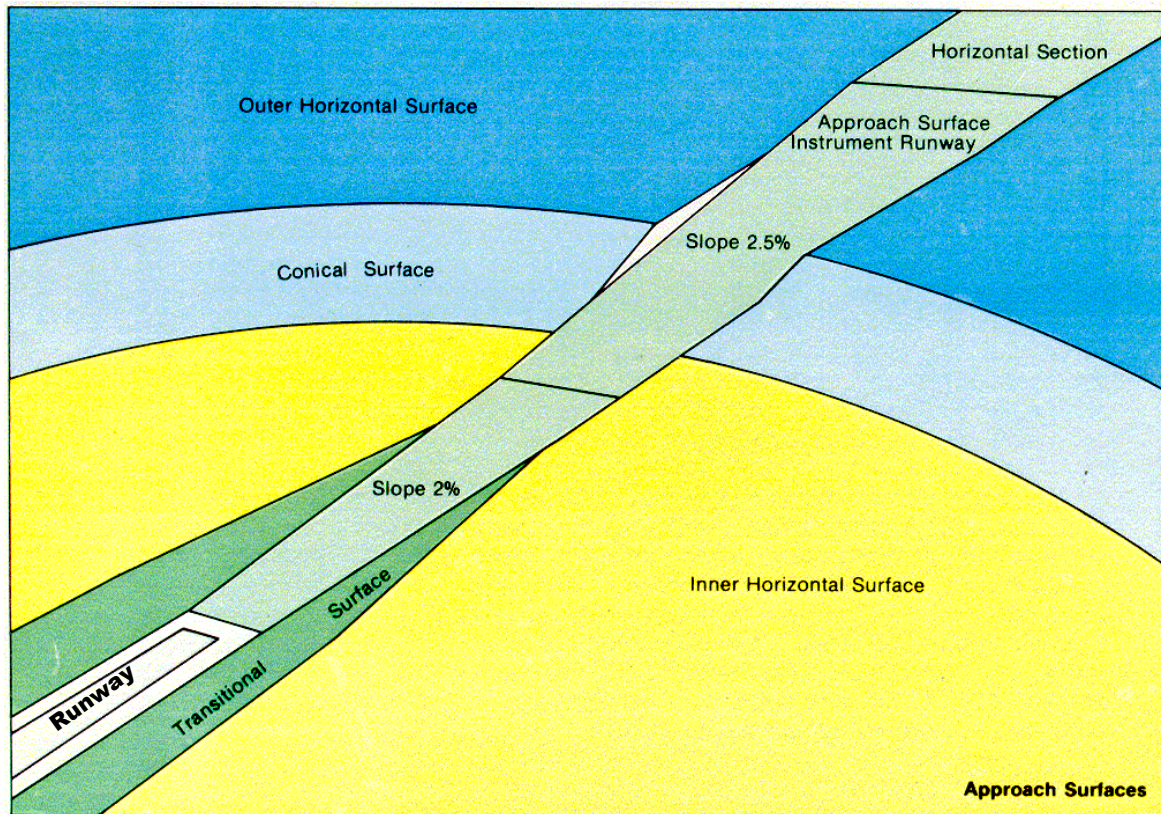


Figure 7.08 (6)-1 Approach surface for an instrument approach runway

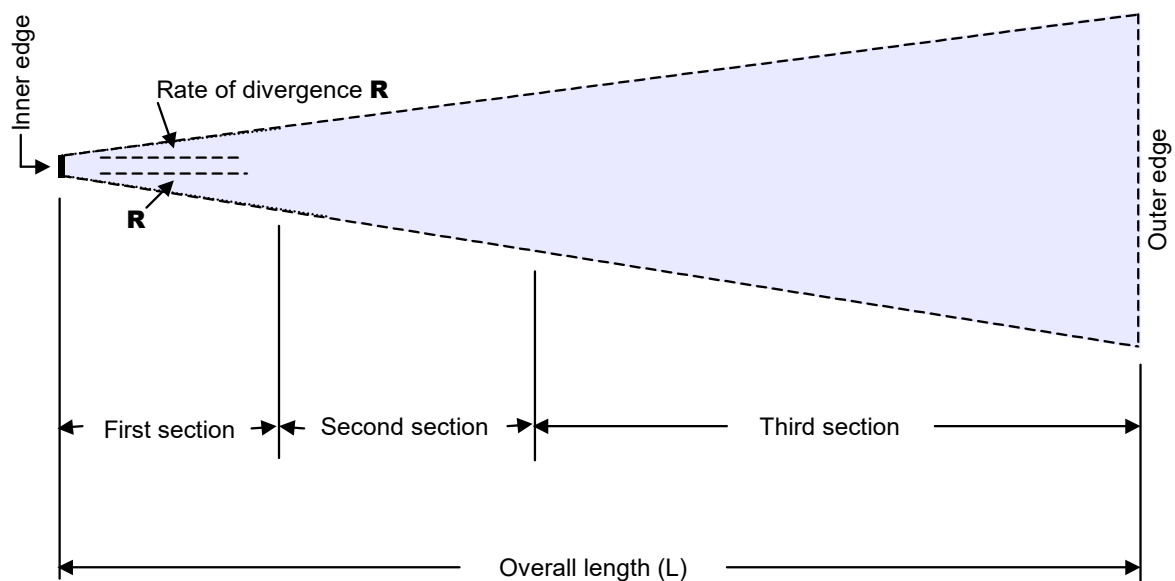


Figure 7.08 (6)-2 Plane view of approach surface

### 7.09 Transitional surface

- (1) The transitional surface:
  - (a) must be comprised of inclined planes that originate:
    - (i) at the lower edge from the side of the runway strip; and
    - (ii) at the side of the approach surface that is below the inner horizontal surface; and

(b) must finish where the upper edge is located in the plane of the inner horizontal surface.

*Note* For guidance only, see Figure 7.08 (6)-1.

- (2) The transitional surface must slope upwards and outwards at a specified rate and be measured in a vertical plane at right angles to the centreline of the runway.
- (3) The elevation of a point on the lower edge of the transitional surface must be:
  - (a) along the side of the approach surface — equal to the elevation of the approach surface at the point; and
  - (b) along the side of the runway strip — equal to the elevation of the nearest point on the centreline of the runway or stopway.

## 7.10 Inner approach surface

The inner approach surface:

- (a) must be a rectangular portion of the approach surface immediately preceding the threshold; and
- (b) must:
  - (i) originate from an inner edge of the length relevantly specified in Table 7.15 (1), at the same location as the inner edge for the approach surface; and
  - (ii) extend on 2 sides, parallel to the vertical plane containing the runway centreline, to an outer edge located at the distance specified in Table 7.15 (1) from, and parallel to, the inner edge.

*Note* For guidance only, see Figure 7.12 (1).

## 7.11 Inner transitional surface

*Note* For general guidance, the inner transitional surface is similar to the transitional surface but closer to a runway used for precision operations.

- (1) The lower edge of the inner transitional surface must originate from the end of the inner approach surface, extend down the sides of the inner approach surface to the inner edge of the inner approach surface, from there extend along the runway strip to the inner edge of the baulked landing surface, and from there extend up the side of the baulked landing surface to the point where the side of the baulked landing surface intersects the inner horizontal surface.
- (2) The elevation of a point on the lower edge of the inner transitional surface must be:
  - (a) along the side of the inner approach and baulked landing surfaces — equal to the elevation of the particular surface at that point; and
  - (b) along the runway strip — equal to the elevation of the nearest point on the centreline of the runway or stopway.
- (3) The inner transitional surface must slope upwards and outwards at the relevant rate specified in Table 7.15 (1), and is to be measured in a vertical plane at right angles to the centreline of the runway.
- (4) The upper edge of the inner transitional surface must be located in the plane of the inner horizontal surface.

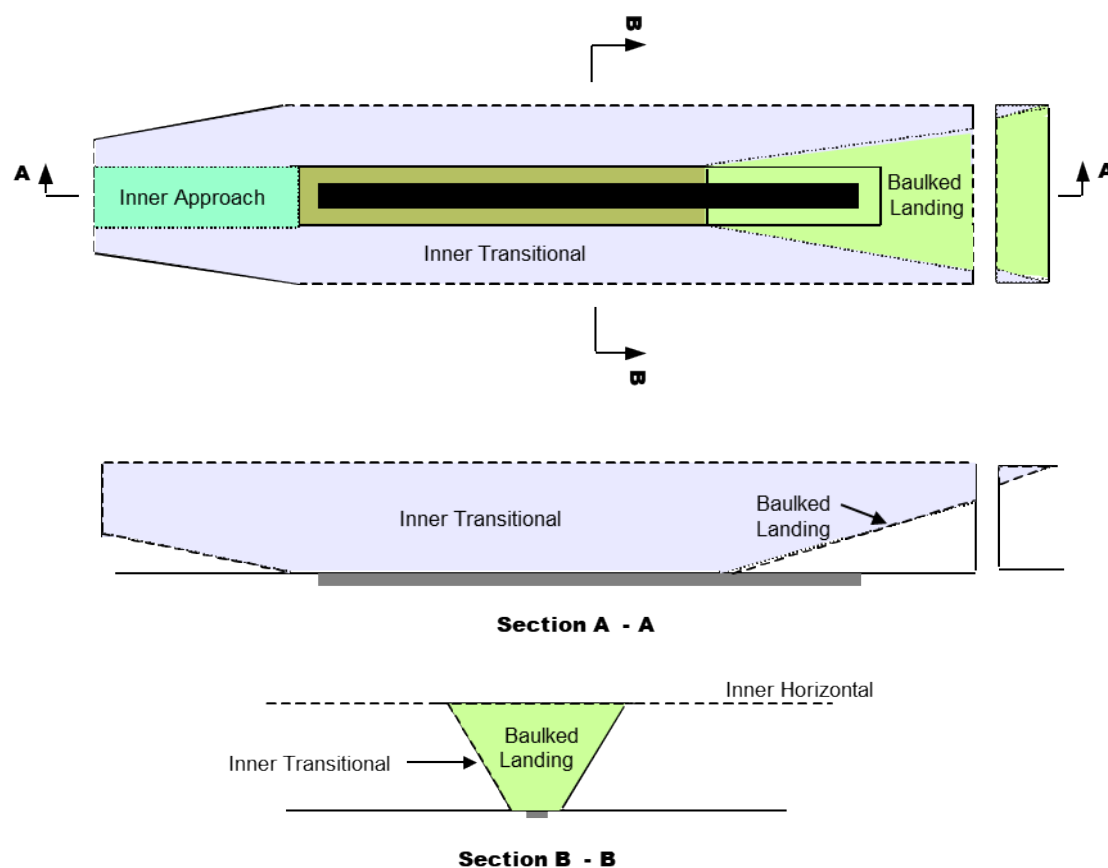
*Note* For guidance only, see Figure 7.12 (1). CASA recommends that, subject to sections 6.55 and 6.56, the inner transitional surface should otherwise be used as the controlling surface for navigational aids, and aircraft

and vehicle holding positions, which have to be located near the runway. The transitional surface should also be used as the controlling surface for building height control.

## 7.12 Baulked landing surface

*Note* For guidance only, see Figure 7.12 (1).

- (1) The baulked landing surface must be an inclined plane originating at the relevant distance specified in Table 7.15 (1) after the threshold, and extending between the inner transitional surfaces.
- (2) The baulked landing surface must originate from an inner edge of the length specified in Table 7.15 (1) located horizontally and perpendicular to the centreline of the runway, with 2 sides from the ends of the inner edge diverging uniformly at the specified rate from the vertical plane containing the centreline of the runway, ending at an outer edge located in the plane of the inner horizontal surface.
- (3) The elevation of the inner edge must be equal to the elevation of the runway centreline at the location of the inner edge.
- (4) The specified slope of the baulked landing surface must be measured in the vertical plane containing the centreline of the runway.



**Figure 7.12 (1) Inner approach, inner transitional and baulked landing OLS (illustrates matters)**

### 7.13 Obstacle-free zone

The obstacle-free zone must be kept free from the following:

- (a) fixed objects or structures other than lightweight, frangibly-mounted navigation aids that must be located near the runway to perform their function;
- (b) transient objects when the runway is being used for precision approaches.

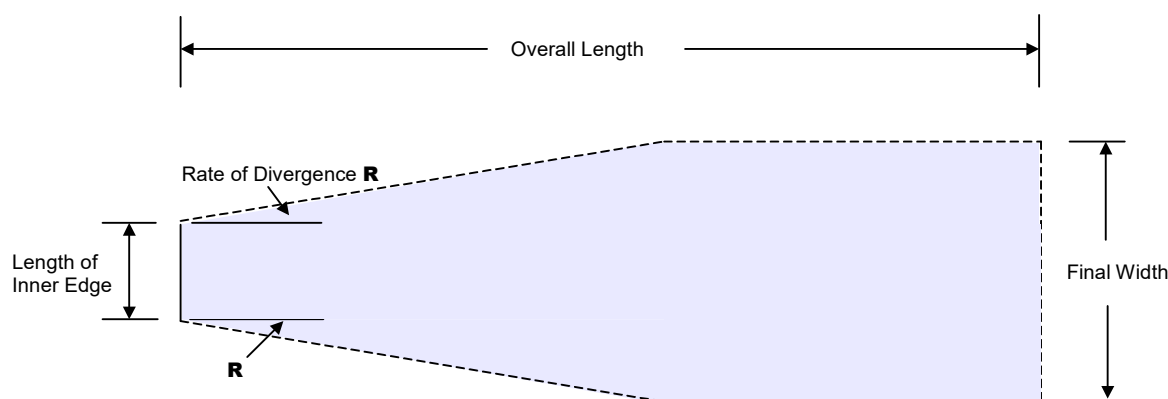
*Note* Transient objects include, for example, aircraft and vehicles.

### 7.14 Take-off climb surface

- (1) The take-off climb surface must be an inclined plane located beyond the end of the runway or clearway.

*Note* For guidance, see Figure 7.14 (1).

- (2) The origin of the take-off climb surface must be the inner edge of the specified length, located at the specified distance from the end of the runway or the clearway.
- (3) The plane from the inner edge must slope upward at the specified rate, with the 2 sides of the plane originating from the ends of the inner edge concurrently diverging uniformly outwards to the final specified width, and continuing thereafter at that width for the remainder of the specified overall length of the take-off climb surface until it reaches the outer edge which is horizontal and perpendicular to the take-off track.
- (4) Subject to subsection 7.14 (5), the elevation of the inner edge must be equal to the highest point on the extended runway centreline between the end of the runway and the inner edge.
- (5) When a clearway is provided, the elevation of the inner edge must be equal to the highest point on the ground on the centreline of the clearway.
- (6) The slope of the take-off climb surface must be measured in the vertical plane containing the centreline of the runway.
- (7) References in this section to dimensions or values that are “specified” are specified in Table 7.16 (1).



**Figure 7.14 (1) Plan view of take-off climb surface**

### 7.15 Approach runways — physical dimensions of the OLS

- (1) The physical dimensions of the OLS for an approach runway are determined from Table 7.15 (1) in accordance with this section.

- (2) Table 7.15 (1) is applied by matching the OLS dimension item in a row of column 1, for which a provision of this MOS mentions that the relevant dimension is specified, with the value in the cell in the same row of the column that is for the type of approach and runway code number.

*Note* For example, for subsection 7.06 (1), the height above the inner horizontal surface is as specified in the column of the row **CONICAL**, *Height (m)* in Table 7.15 (1) that is for the relevant approach and runway code.

- (3) For Table 7.15 (1), all distances are measured horizontally unless otherwise specified under a symbol mentioned in subsection (5).
- (4) The approach climb surface requirements for a code 2 runway apply to a code 1 runway for which lighting is provided.
- (5) For Table 7.15 (1), the superscript letters against certain dimensions have the following meaning:
- **a** means 90 m if the width of the runway is 30 m;
  - **b** — RESERVED;
  - **c** means that no actual ground survey is required unless specifically required by a procedure designer. A procedure designer must use topographical maps and tall structure databanks to determine minimum altitudes;
  - **d** means that the approach area up to this distance must be monitored for new obstacles. The procedure designer’s advice, on significant high ground or tall structures that should be monitored, must also be followed;
  - **e** means the distance to the end of the runway strip;
- Note* Applicable only to *Distance from threshold (m)* dimension item.
- **f** means “or to the end of the runway strip, whichever is less”;
  - **g** means that if the code letter is F from Table 4.01 (4), the length of the baulked landing inner edge must be increased to 140 m.

**Table 7.15 (1) Physical dimensions of the OLS for an approach runway**

OLS (in bold) and dimension items (in italics)	Runway type and code, and OLS values in percentages and metres									
	Non-instrument				Instrument					
					Non-precision			Precision		
	Code				Code			CAT I Code		CAT II & III Code
1	2	3	4	1, 2	3	4	1, 2	3, 4	3, 4	
<b>OUTER HORIZONTAL</b>										
<i>Height (m)</i>									150	150
<i>Radius (m)</i>									15000	15000
<b>CONICAL</b>										
<i>Slope</i>	5%	5%	5%	5%	5%	5%	5%	5%	5%	5%
<i>Height (m)</i>	35	55	75	100	60	75	100	60	100	100
<b>INNER HORIZONTAL</b>										

<b>OLS (in bold) and dimension items (in italics)</b>	<b>Runway type and code, and OLS values in percentages and metres</b>									
	<b>Non-instrument</b>				<b>Instrument</b>					
					<b>Non-precision</b>			<b>Precision</b>		
	<b>Code</b>				<b>Code</b>			<b>CAT I Code</b>		<b>CAT II &amp; III Code</b>
1	2	3	4	1, 2	3	4	1, 2	3, 4	3, 4	
<i>Height (m)</i>	45	45	45	45	45	45	45	45	45	45
<i>Radius (m)</i>	2000	2500	4000	4000	3500	4000	4000	3500	4000	4000
<b>APPROACH</b>										
<i>Length of inner edge (m)</i>	60	80	150 <sup>a</sup>	150	140	280	280	140	280	280
<i>Distance from threshold (m)</i>	30	60	60	60	60	60	60	60	60	60
<i>Divergence each side</i>	10%	10%	10%	10%	15%	15%	15%	15%	15%	15%
<i>First section length (m)</i>	1600	2500	3000	3000	2500	3000	3000	3000	3000	3000
<i>Slope</i>	5%	4%	3.33%	2.5%	3.33%	2%	2%	2.5%	2%	2%
<i>Second section length (m)</i>	-	-	-	-	-	3600 <sup>c</sup>	3600	12000	3600	3600
<i>Slope</i>	-	-	-	-	-	2.5% <sup>c</sup>	2.5%	3%	2.5%	2.5%
<i>Horizontal section length (m)</i>	-	-	-	-	-	8400 <sup>c</sup>	8400	-	8400	8400
<i>Total length (m)</i>	1600	2500	3000	3000	2500	15000 <sup>d</sup>	15000	15000	15000	15000
<b>INNER APPROACH</b>										
<i>Width (m)</i>								90	120	120
<i>Distance from threshold (m)</i>								60	60	60
<i>Length (m)</i>								900	900	900
<i>Slope</i>								2.5%	2%	2%
<b>TRANSITIONAL</b>										
<i>Slope</i>	20%	20%	14.3%	14.3%	20%	14.3%	14.3%	14.3%	14.3%	14.3%
<b>INNER TRANSITIONAL</b>										
<i>Slope</i>								40%	33.3%	33.3%
<b>BAULKED LANDING</b>										
<i>Length of inner edge (m)</i>								90	120 <sup>g</sup>	120 <sup>g</sup>
<i>Distance from threshold (m)<sup>e</sup></i>									1800 <sup>f</sup>	1800
<i>Divergence each side</i>								10%	10%	10%
<i>Slope</i>								4%	3.3%	3.3%

*Note* For information on code F aeroplanes equipped with digital avionics providing steering commands to maintain an established track during a go-around manoeuvre, see ICAO Circular 301 – *New Larger Aeroplanes – Infringement of the Obstacle Free Zone: Operational Measures and Aeronautical Study*. For ICAO documents, see section 1.07.

## 7.16 Take-off runways — physical dimensions of the take-off climb surface

- (1) The physical dimensions of the take-off climb surface for a take-off runway are determined from Table 7.16 (1) in accordance with this section.
- (2) Table 7.16 (1) is applied by matching the dimension in a row of column 1, for which a provision mentions that the dimension is specified, with the value in the cell in the same row of the column that is for the relevant take-off runway code number.
- (3) The take-off climb surface requirements for a code 2 runway apply to a code 1 runway for which lighting is provided.
- (4) For Table 7.16 (1), the superscript letters against certain dimensions have the following meaning:
  - **a** means that the take-off climb starts from the end of the clearway, if a clearway is provided;
  - **b** means that the final runway width may be reduced to 1 200 m — but only if the runway is used only by aircraft with take-off procedures which do not include changes of heading greater than 15 degrees for operations conducted in IMC or at night.

**Table 7.16 (1) Physical dimensions of the OLS for a take-off runway**

Take-off climb surface — elements and dimensions	Take-off runway code number and corresponding values (in metres and percentages)		
	Code 1 runway	Code 2 runway	Code 3 or 4 runway
Length of inner edge	60	80	180
Minimum distance of inner edge from runway end <sup>a</sup>	30	60	60
Rate of divergence (each side)	10%	10%	12.5%
Final width	380	580	1800 <sup>b</sup>
Overall length	1600	2500	15000
Slope	5%	4%	2%

## 7.17 Establishment of the OLS

- (1) The following OLS must be established for a non-instrument runway and a non-precision instrument runway:
  - (a) the conical surface;
  - (b) the inner horizontal surface;
  - (c) the approach surface;
  - (d) the transitional surface;
  - (e) the take-off climb surface.



- (2) The following OLS must be established for a precision approach runway:
  - (a) the outer horizontal surface;
  - (b) the conical surface;
  - (c) the inner horizontal surface;
  - (d) the approach surface;
  - (e) the inner approach surface;
  - (f) the transitional surface;
  - (g) the inner transitional surface;
  - (h) the baulked landing surface;
  - (i) the take-off climb surface.
- (3) Where 2 OLS overlap, the lower surface must be used as the controlling obstacle limitation surface.

### **7.18 Procedures for aerodrome operators to deal with obstacles in the OLS**

- (1) An aerodrome operator must:
  - (a) monitor the OLS for the aerodrome; and
  - (b) report to CASA, in writing, any infringement, or potential infringement, of the OLS.
- (2) When a new obstacle is identified, the aerodrome operator must ensure that pilots are informed of it by NOTAM.
- (3) For subsection (2), unless otherwise stated in the data product specification (**DPS**) for the aerodrome, the information must include the following:
  - (a) the nature of the obstacle;

*Note* For example, whether the obstacle is a structure or machinery or of another kind.
  - (b) the distance and bearing of the obstacle from:
    - (i) if the obstacle is within the take-off area — the start of the take-off end of the runway; or
    - (ii) the ARP;
  - (c) the height of the obstacle in relation to the aerodrome elevation;
  - (d) if it is a temporary obstacle — the time during which it is a temporary obstacle.

*Note* If CASA declares an obstacle within the aerodrome boundary as being hazardous, it may result in an operational limitation on the aerodrome from aircraft operators, or a relevant safety direction from CASA under regulation 11.245 of CASR, unless the hazardous obstacle is removed.

### **7.19 Objects or structures that could become obstacles in the OLS**

- (1) If a proposed object or structure is identified as likely to be an obstacle, details of the relevant proposal must be referred to CASA for CASA to determine, in writing:
  - (a) whether the object or structure will be a hazard to aircraft operations; and
  - (b) whether it requires an obstacle light that is essential for the safety of aircraft operations.

*Note* See also paragraph 9.36 (2) (c).

- (2) A runway must not be made available for night use for the first time until:
  - (a) the aerodrome operator has informed CASA of obstacles within the OLS; and
  - (b) CASA has determined that the obstacles will not adversely affect the safety of night operations.

#### Temporary and transient obstacles

- (3) A temporary or transient obstacle:
  - (a) in close proximity to an aerodrome; and
  - (b) that infringes the OLS;must be referred to CASA to determine whether the obstacle will be a hazard to aircraft operations.

*Note* Transient obstacles would include, for example, road vehicles, rail carriages and ships.

#### Fences or levee banks

- (4) A fence or levee bank that infringes the OLS must be treated as an obstacle.
- (5) For this section:
  - (a) referrals or information to CASA must be made by the aerodrome operator in writing; and
  - (b) determinations by CASA must be in writing.

### 7.20 Monitoring of obstacles associated with instrument runways

- (1) An aerodrome operator must monitor any object or structure that may infringe the aerodrome's OLS and PANS-OPS airspace associated with instrument approach procedures.

*Note* Under regulation 173.110 of CASR, instrument approach procedure designers provide aerodrome operators with information and drawings of the area around the aerodrome, showing the designed approach paths, the circling areas and locations of critical obstacles taken into account in the design.

- (2) An aerodrome operator must:
  - (a) establish procedures to monitor:
    - (i) the OLS; and
    - (ii) such obstacles, associated with the aerodrome's terminal instrument flight procedures, as are determined by the instrument flight procedure designer to be critical obstacles; and
  - (b) include the procedures in the aerodrome manual.
- (3) The aerodrome operator must inform the designer of a terminal instrument flight procedure at the aerodrome of the following:
  - (a) any change in the status of an existing critical obstacle;
  - (b) any proposed development that is to be higher than the critical obstacles within the area depicted by the designer;
  - (c) any new object or structure that is higher than the critical obstacles within the area depicted by the designer.

## CHAPTER 7

### Division 3 Aerodrome obstacle and terrain charts

#### 7.21 Type A charts

- (1) An aerodrome operator must prepare a Type A chart:
  - (a) for each runway at the aerodrome that is used in scheduled international air transport operations; and
  - (b) that is:
    - (i) included in the aerodrome manual; or
    - (ii) recorded as an Aerodrome Terrain and Obstacle Chart – ICAO (Electronic).
- (2) Subsection (1) does not apply if the same information is provided in the Aerodrome Terrain and Obstacle Chart – ICAO (Electronic).

*Note* See section 7.24.

- (3) The obstacle data to be collected, and the way the Type A chart is presented, must be in accordance with the standards and procedures set out in ICAO Annex 4.
- (4) For a Type A chart, obstacle data must be in a digital format and be provided to the AIS provider in accordance with Subpart 175.E of CASR.
- (5) If no obstacle exists within the take-off flight path area, as specified by ICAO Annex 4, a Type A chart is not required, but a statement to this effect with an explanatory note must be included in the aerodrome manual.
- (6) If a Type A chart has been prepared, or updated, a copy of the chart must be given to CASA as soon as reasonably practicable.
- (7) If a Type A chart has been prepared and issued, the take-off flight area must be monitored and any changes to the Type A chart information must be communicated as soon as possible to all Type A chart holders on the list mentioned in subsection (9).
- (8) The currency and accuracy of the following must be confirmed as part of the aerodrome technical inspection:
  - (a) the Type A chart;
  - (b) the aerodrome operator's obstacle monitoring procedures;
  - (c) the distribution list of current Type A chart holders.

*Note* Changes to the Type A chart information but not to the take-off climb surface of the OLS do not require NOTAM action. If a change to Type A chart information is also the subject of NOTAM action, additional separate advice to the Type A chart holders is not required.

- (9) The aerodrome manual must contain:
  - (a) an up-to-date distribution list of current Type A chart holders (*the list*); or
  - (b) reference to another document (including its location) which contains the list.

*Note* For ICAO documents, see section 1.07.

## 7.22 Type B charts

- (1) An aerodrome operator may prepare a Type B chart but only in accordance with the standards and procedures set out in ICAO Annex 4.

*Note* A Type B chart is discretionary, but may assist some operators of aircraft with a maximum take-off weight greater than 5 700 kg to identify obstacles around an aerodrome. However, a Type B chart is not required if Type B obstacle data is included in the Aerodrome Terrain and Obstacle Chart – ICAO (Electronic) (see section 7.24).

- (2) The obstacle data to be collected, and the way the Type B chart is presented, must be in accordance with ICAO Annex 4.
- (3) For a Type B chart, obstacle data must be in a digital format and be provided to the AIS provider in accordance with Subpart 175.E CASR.

*Note* For ICAO documents, see section 1.07.

## 7.23 Precision Approach Terrain Charts — ICAO

- (1) A Precision Approach Terrain Chart — ICAO must be prepared:
  - (a) for each precision approach runway at an aerodrome that is CAT II, CAT III, SA CAT I or SA CAT II; and
  - (b) in accordance with the standards and procedures in ICAO Annex 4.

*Note* For ICAO documents, see section 1.07.

- (2) Subsection (1) does not apply if the same information is provided in the Aerodrome Terrain and Obstacle Chart – ICAO (Electronic).
- (3) A Precision Approach Terrain Chart — ICAO must be revised as soon as possible after any significant change occurs to the relevant terrain profile.
- (4) For a Precision Approach Terrain Chart – ICAO, terrain data must be:
  - (a) in a digital format; and
  - (b) provided to the AIS provider in accordance with Subpart 175.D of CASR.

## 7.24 Aerodrome Terrain and Obstacle Charts — ICAO (Electronic)

- (1) An aerodrome operator may prepare an Aerodrome Terrain and Obstacle Chart – ICAO (Electronic) but only in accordance with the standards and procedures set out in ICAO Annex 4.
- (2) An Aerodrome Terrain and Obstacle Chart — ICAO (Electronic) must be revised as soon as possible after any significant change occurs to the relevant terrain profile or obstacles.
- (3) For an Aerodrome Terrain and Obstacle Chart – ICAO (Electronic), terrain data must be:
  - (a) in a digital format; and
  - (b) provided to the AIS provider in accordance with Subparts 175.D and 175.E of CASR.

*Note* For ICAO documents, see section 1.07.

## CHAPTER 7

### Division 4 Principles of shielding

#### 7.25 General

- (1) An aerodrome operator must inform CASA in writing of the presence of all obstacles at the aerodrome.
- (2) Subject to subsection (3), only CASA may determine whether or not a new obstacle is shielded by an existing obstacle.
- (3) An aerodrome operator may assess whether a new obstacle is shielded by an existing obstacle only if the assessment is made for publication in the operator's Type A chart.
- (4) A new obstacle is not to be considered as being shielded by an existing obstacle unless:
  - (a) CASA determines in writing that the new obstacle is shielded; or
  - (b) the aerodrome operator assesses, for publication in their Type A chart, that the new obstacle is shielded and the assessment has not been replaced by a CASA determination that the new obstacle is not shielded.
- (5) An aerodrome operator may apply in writing to CASA for a written determination on whether or not an obstacle is shielded.

*Note* A new obstacle, located in the vicinity of an existing obstacle, and assessed as not being a hazard to aircraft, would be considered to be shielded. Only existing permanent obstacles may be considered in assessing the applicability of shielding of new obstacles.

**CHAPTER 8 VISUAL AIDS PROVIDED BY AERODROME MARKINGS, MARKERS, SIGNALS, SIGNS, WIND DIRECTION INDICATORS ETC.**

**Division 1 General**

**8.01 General**

- (1) All visual aids, including wind direction indicators, must be:
  - (a) clearly visible; and
  - (b) designed, sited, marked and placed as required by the applicable standards under this Chapter; and
  - (c) maintained to the standard that is required for the aid or indicator under this Chapter.
- (2) Relevant standards under this Chapter are expressed in metric units.

**8.02 Permanent aerodrome or partial movement area closure**

Unless a provision of this Chapter expressly provides otherwise, on a closed aerodrome or a closed part of the movement area of an aerodrome, all markings, markers, signals and signs (other than those indicating unserviceability) must be obscured or removed.

**8.03 Colours**

- (1) Colours used in aerodrome markings, markers, signals and signs must meet Australian Standard AS 2700-2011, *Colour Standards for General Purposes*, as in force or existing from time to time, in accordance with Table 8.03 (1).

*Note* Australian Standard AS 2700-2011, *Colour Standards for General Purposes*, is available from the Australian Standards website: <http://www.standards.org.au/searchandbuyastandard/pages/default.aspx>.

- (2) For Table 8.03 (1), a colour mentioned in a row in column 1 has the Australian Standard (**AS**) colour code and the AS colour name mentioned in the same row in columns 2 and 3, respectively.

**Table 8.03 (1) Standard colours for aerodrome markings, markers, signals and signs**

Example of colour	AS colour code	AS colour name
Blue	B41	Blue bell
Green	G35/G26	Lime/apple green
Orange	X15	Orange
Red	R13/R14/R15	Signal red, waratah or crimson. AS Code R13, signal red, is preferred. However AS Code R14 or R15 may be used if AS Code R13 cannot be sourced.
Yellow	Y14	Golden yellow
White	N14	White
Black	N61	Black

#### **8.04 Visibility of markings and markers**

- (1) Each marking and marker must be clearly visible against the background and environment in which it is placed.
- (2) Unless the colour is otherwise stated in this Chapter, the selection of the surrounding colour for a marking must be white, grey or black, whichever is the most appropriate to provide sufficient contrast to ensure that the marking is clearly visible.
- (3) The width of a contrasting surround for a marking must be:
  - (a) for a line marking with a width up to and including 0.3 m — not less than the line width of the marking; and
  - (b) for a marking with a width greater than 0.3 m — not less than 0.3 m; and
  - (c) for all other markings — not more than 0.3 m.

#### **8.05 Dimensions and tolerances of markings**

- (1) Subject to subsection (2), markings required by this Chapter must meet the metric dimensions specified in this Chapter for the marking.
- (2) If it is not physically possible to comply with subsection (1), a marking may be:
  - (a) not more than 5% smaller than the dimensions specified for it; or
  - (b) not more than 5% or 0.1 m (whichever is the lesser) larger than the dimensions specified for it.
- (3) A tolerance mentioned in paragraph (2) (a) or (b) must be applied uniformly to the whole marking.
- (4) Despite subsection (2), the ratios for the height and width of markings must be preserved within the specifications in this Chapter for markings.
- (5) Despite subsection (2), the ratios between markings must be preserved within the specifications specified in this Chapter for markings.
- (6) The letters, numbers and symbols provided in a marking must be in the form and proportions mentioned in section 8.69, unless otherwise provided for in this Chapter.

## CHAPTER 8

### Division 2 Markers

#### 8.06 Introduction

- (1) A marker must be lightweight and frangible in accordance with Division 11 of this Chapter.
- (2) When displayed, a marker must be secured against propeller wash and jet blast to ensure it does not cause a hazard to aircraft.

#### 8.07 Cones

- (1) A cone used as runway edge marker or a taxiway edge marker must:
  - (a) be 0.3 m high; and
  - (b) have a base diameter of 0.4 m.
- (2) A cone used other than as a runway edge marker or a taxiway edge marker must:
  - (a) be 0.5 m high; and
  - (b) have a base diameter of 0.75 m; and
  - (c) be placed to provide not less than 0.1 m of vertical clearance from the bottom of the vertical propeller or engine pod of the aircraft:
    - (i) that is regularly using the aerodrome; and
    - (ii) whose propeller or pod is closest to the ground of the aircraft which the runway is appropriately nominated by the aerodrome operator to serve.
- (3) A cone mentioned in a row of column 1 of Table 8.07 (3)-1 must be in the colour or colours mentioned in column 2 that is for the same row, and be as illustrated in Figure 8.07 (3)-2.

**Table 8.07 (3)-1 Colour of cones**

Marker cone	Colour
Runway edge marker	White
Taxiway edge marker	Yellow
Apron edge marker	Yellow
Runway strip marker	White
Helicopter apron edge marker	Blue
Helicopter taxiway edge marker	Blue
Unserviceability marker	White, with central 25 cm <b>red band</b>
Runway strip marker (displaced threshold)	Split white and suitable background colour





**Figure 8.07 (3)-2 Cone markers (illustrates matters)**

### **8.08 Works limit markers**

- (1) Works limit markers must be clearly visible.
- (2) Barriers around works must be:
  - (a) all red; or
  - (b) all orange; or
  - (c) red and white, or orange and white, but with sufficient white to ensure contrast.

- (3) Works limit markers must not have weight, size, shape, colour, texture or material characteristics which may make them a hazard to aircraft operations.

*Note* For example, works limit markers which are too light in weight, or which are too aerodynamically shaped, may become airborne in strong winds and strike aircraft.

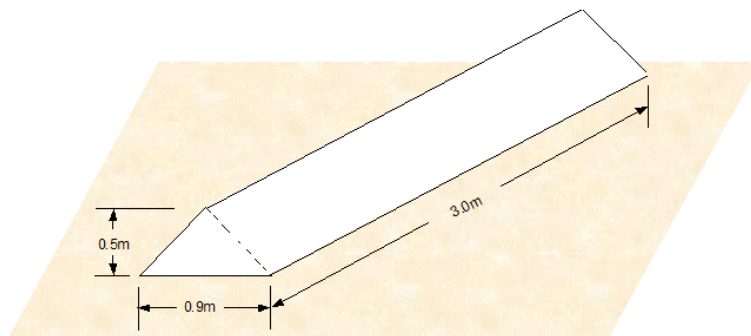
- (4) Works limit markers must be spaced at intervals that ensure they are clearly visible to works personnel, including works personnel using works equipment or vehicles.
- (5) When used on a movement area, works limit markers must:
  - (a) be placed inside the barriers around the works and behind unserviceability markings; and
  - (b) not be used to convey information to pilots about changes to the movement area.

## 8.09 Gable markers

Gable markers for a runway strip must be:

- (a) 3 m long; and
- (b) 0.9 m wide; and
- (c) 0.5 m high; and
- (d) triangular (gable) in shape continued along the full length of the marker; and
- (e) white in colour.

*Note* See the illustration in Figure 8.09.



**Figure 8.09 Gable marker (illustrates matters)**

## 8.10 Flush runway strip markers

A flush runway strip marker must be:

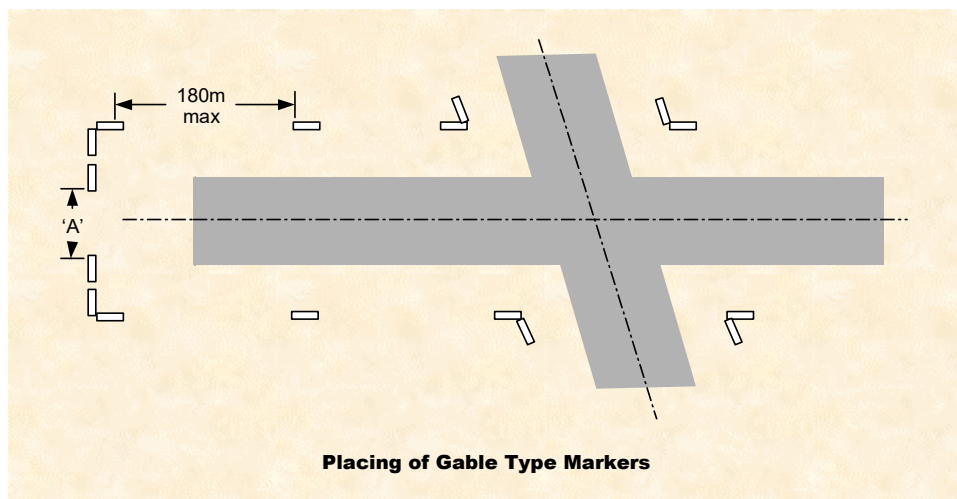
- (a) 3 m long; and
- (b) 0.9 m wide; and
- (c) placed lengthways along, and flush with, the boundary of the runway strip.

## 8.11 The use of markers on a runway strip

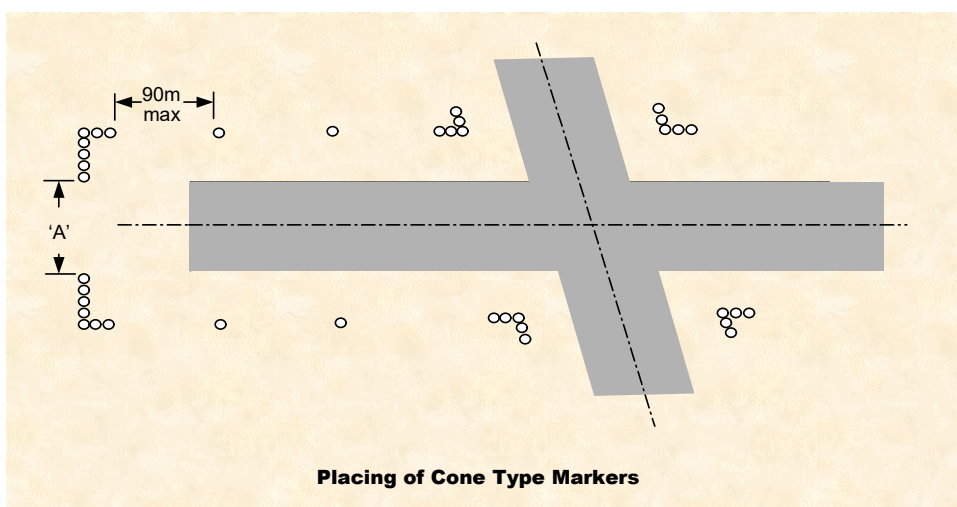
- (1) Runway strip markers must be placed along the edges of the graded portion of a runway strip.
- (2) Runway strip markers must be white coloured:
  - (a) gable markers; or
  - (b) cones; or
  - (c) flush runway strip markers.
- (3) If flush runway strip markers are used, they must:
  - (a) clearly define the boundary of the runway strip for ground vehicles with access to the runway strip; and
  - (b) be free of contamination from grass, weeds, dirt, rubbish or similar matter.

*Note* For consistency and to minimise the risk of confusion, CASA recommends that gable markers, cones and flush runway strip markers not be mixed.

- (4) The distance between gable runway strip markers must not exceed 180 m as shown in Figure 8.11 (4).
- (5) The distance between cone runway strip markers must not exceed 90 m as shown in Figure 8.11 (5).



**Figure 8.11 (4) Runway strip markers — gable markers (shows matters)**



**Figure 8.11 (5) Runway strip markers — cones (shows matters)**

- (6) For subsection (4), if the width of the graded strip is mentioned in a row in column 1 of Table 8.11 (6), the width of the area labelled “A” in Figures 8.11 (4) and 8.11 (5) must be at least that mentioned in the same row in column 2.

**Table 8.11 (6) Minimum width of dimension “A” in Figures 8.11 (4) and (5)**

Width of graded strip	Dimension “A”
30 m	10 m minimum
45 m	20 m minimum
60 m	20 m minimum
90 m	30 m minimum
150 m	60 m minimum

### 8.12 The use of markers on an unsealed runway

- (1) On an unsealed runway, if:
  - (a) there is a lack of contrast between the runway and the runway strip; and
  - (b) the whole of the runway strip is not maintained to normal runway grading standards;then:
  - (c) runway markers must be provided along both sides of the runway; and
  - (d) the distance between each marker must not exceed 90 m; and
  - (e) the thresholds must be marked by normal threshold markings or runway cone markers in the applicable pattern as shown in Figure 8.11 (4) or 8.11 (5) for runway strip ends.
- (2) On an unsealed runway, if the whole of the runway strip is maintained to normal runway grading standard, then:
  - (a) runway markers may be omitted and replaced by runway strip markers placed along the edges of the runway strip; and
  - (b) the thresholds must be marked by normal threshold markings or runway cone markers in a pattern similar to the pattern shown in Figure 8.11 (4) or 8.11 (5) for runway strip ends.
- (3) If an unsealed runway has a permanently displaced threshold at one end, then:
  - (a) 2 sets of runway strip markers must be provided at that end; and
  - (b) each set must be bi-coloured; and
  - (c) the set associated with the permanently displaced threshold must be coloured so that:
    - (i) the half facing the direction of approach (the **first direction**) appears white; and
    - (ii) the other half:
      - (A) matches the background; and
      - (B) is inconspicuous to a pilot operating in the other direction (the **second direction**); and
  - (d) markers associated with the runway strip end must appear:
    - (i) white in the second direction; and
    - (ii) inconspicuous in the first direction.

- (4) For:
  - (a) the displaced threshold — the bi-coloured end markers must be cones; and
  - (b) the runway strip end — the bi-coloured end markers must be cones or gables.
- (5) Markers for the edges of an unsealed runway turn pad must be:
  - (a) yellow cones; and
  - (b) placed to enable pilots to clearly identify the edge of the unsealed turn pad.

### **8.13 The use of markers on an unsealed taxiway**

- (1) If the edge of a trafficable unsealed taxiway is not visible to the pilot in the cockpit of an aircraft, then taxiway edge markers must be provided along the taxiway edge.
- (2) Taxiway edge markers must:
  - (a) be yellow cones; and
  - (b) be placed:
    - (i) preferably along on the edge of the unsealed taxiway; or
    - (ii) no more than 1 m outside the edge of the unsealed taxiway provided the section between the taxiway edge and the marker is graded to the same standard as the taxiway; and
  - (c) provide not less than 0.1 m of vertical clearance from the propeller or engine pod of the aircraft that:
    - (i) is regularly using the aerodrome; and
    - (ii) being an aircraft which the runway is appropriately nominated by the aerodrome operator to serve — is closest to the ground; and
  - (d) enable pilots to clearly identify the edge of the unsealed taxiway.
- (3) If markers are used to delineate the graded edge of the taxiway strip or the overall edge of the taxiway strip, they must:
  - (a) conform to the specification of subsection 8.07 (2) and
  - (b) be provided in addition to taxiway edge markers.

### **8.14 The use of markers on an unsealed apron**

- (1) If any part of the edge of an unsealed apron is not visible to the pilot in the cockpit of an aircraft, then apron edge markers must be provided along the apron edge.
- (2) The apron edge markers must be yellow cones placed at a maximum distance of 30 m apart.

## CHAPTER 8

### Division 3 Runway markings

#### 8.15 Introduction

- (1) Runway markings on sealed runway surfaces must be white.
- (2) Pre-threshold markings must be yellow.
- (3) At runway intersections, markings of the runway with the highest nominated code, or the highest aircraft movement rate, must take precedence over, or interrupt, the markings of the other runway.
- (4) At a runway intersection with a taxiway, the runway markings, other than runway side strip markings, must interrupt the taxiway markings.
- (5) The surface of runway markings must:
  - (a) have a surface texture not less than the minimum required for the surrounding runway surface; or
  - (b) if meeting the requirement in paragraph (a) is not possible — not adversely affect the required coefficient of friction of the runway surface.

*Note* This is to reduce the risk of uneven braking action.

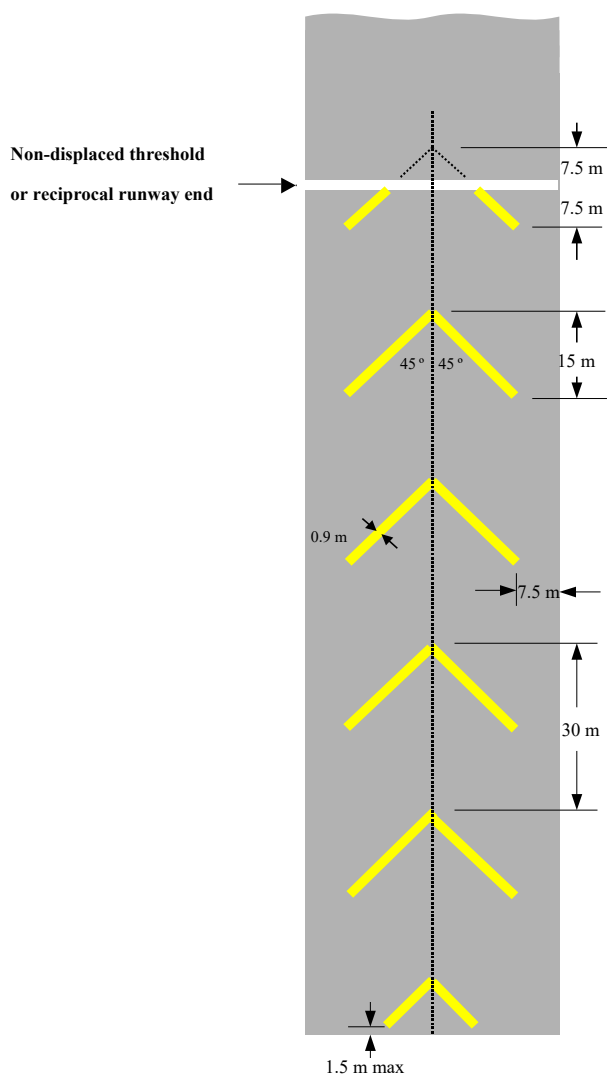
#### 8.16 Pre-threshold area markings

- (1) If an area before the non-displaced threshold, or the runway end in the reciprocal direction:
  - (a) has a sealed, concrete or asphalt surface; and
  - (b) exceeds 60 m in length; and
  - (c) is not suitable for normal aircraft usage;then pre-threshold area markings must be used.

*Note* This does not apply to runway starter extensions.

- (2) As shown in Figure 8.16 (2), pre-threshold area markings must consist of a sequence of yellow chevrons that:
  - (a) have lines 0.9 m wide, angled 45 degrees to the runway centreline; and
  - (b) are spaced 30 m apart, as measured from the apex of one chevron to the apex of the next chevron; and
  - (c) are 15 m tall from apex to base; and
  - (d) point towards the non-displaced threshold, or the runway end in the reciprocal direction, as the case may be; and
  - (e) except where affected by the proximity of the non-displaced threshold or the runway end in the reciprocal direction — have line ends sufficiently long to end not more than 7.5 m from the respective runway edges; and
  - (f) terminate at the runway end marking.

*Note* This area will not normally be used for landing or take-off. If declared as a stopway, only an aircraft in an abandoned take-off from the other direction may use the area.



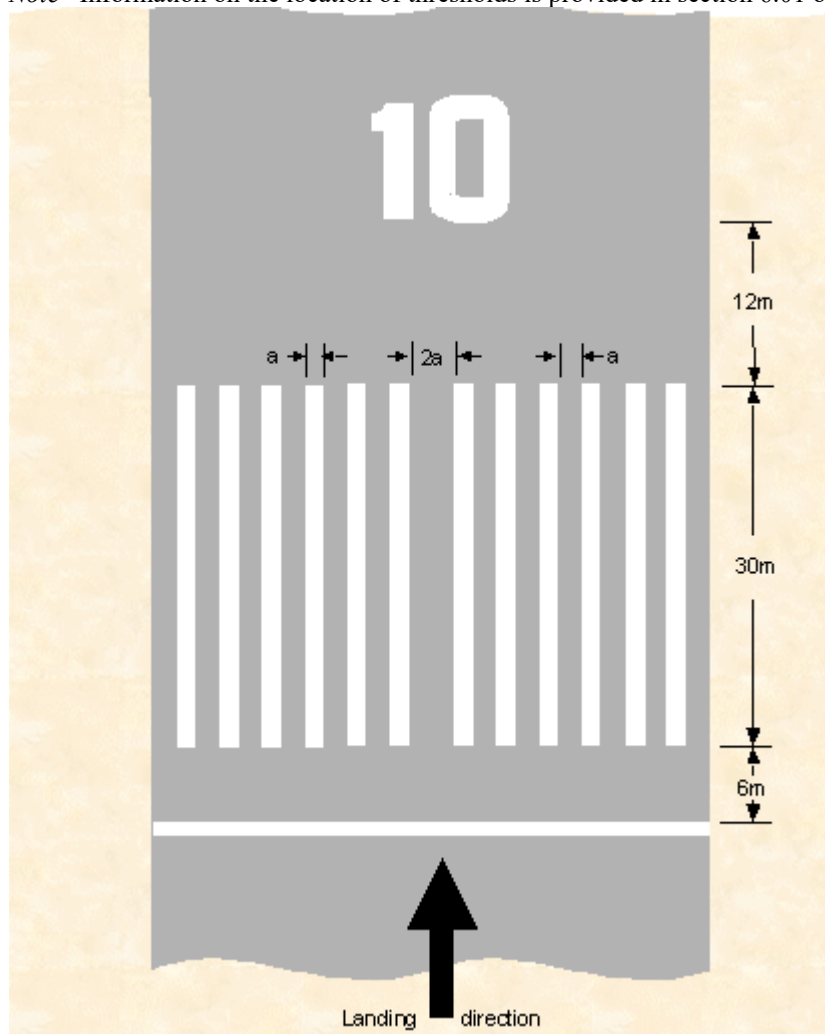
**Figure 8.16 (2) Pre-threshold area markings (shows matters)**

### 8.17 Runway threshold markings

- (1) Runway threshold markings must be provided:
  - (a) on a sealed, concrete or asphalt runway; and
  - (b) on an unsealed runway with sealed, concrete or asphalt thresholds.
- (2) As shown in Figure 8.17 (2), a permanent threshold, or a permanently displaced threshold, must be indicated by:
  - (a) a white transverse line, commencing from the location of the threshold as determined under section 6.01, which is 1.2 m wide and extends the full width of the runway at the location of the threshold; and
  - (b) beyond the line, white “piano key” markings, consisting of adjacent, uniformly spaced, 30 m long stripes whose number and width is determined in accordance with Table 8.17 (2).

- (3) If the normal threshold marking is not marked because the threshold surface is unsealed, runway markers must be used to delineate the ends of an unsealed runway.

*Note* Information on the location of thresholds is provided in section 6.01 of this MOS.



**Figure 8.17 (2) Runway threshold markings (shows matters)**

- (4) For paragraph (2) (b), for a runway whose width is mentioned in a row of column 1 of Table 8.17 (2), the number of stripes, and the width of the spaces between each stripe, is the number and the width mentioned in the same row of columns 2 and 3, respectively.

**Table 8.17 (2) Number of stripes and width of stripe spaces**

Runway width	Number of stripes	Width of stripe space (denoted as “a” in Figure 8.17 (2))
18 m	4	1.5 m
23 m	6	1.5 m
30 m	8	1.5 m
45 m	12	1.7 m
60 m	16	1.7 m



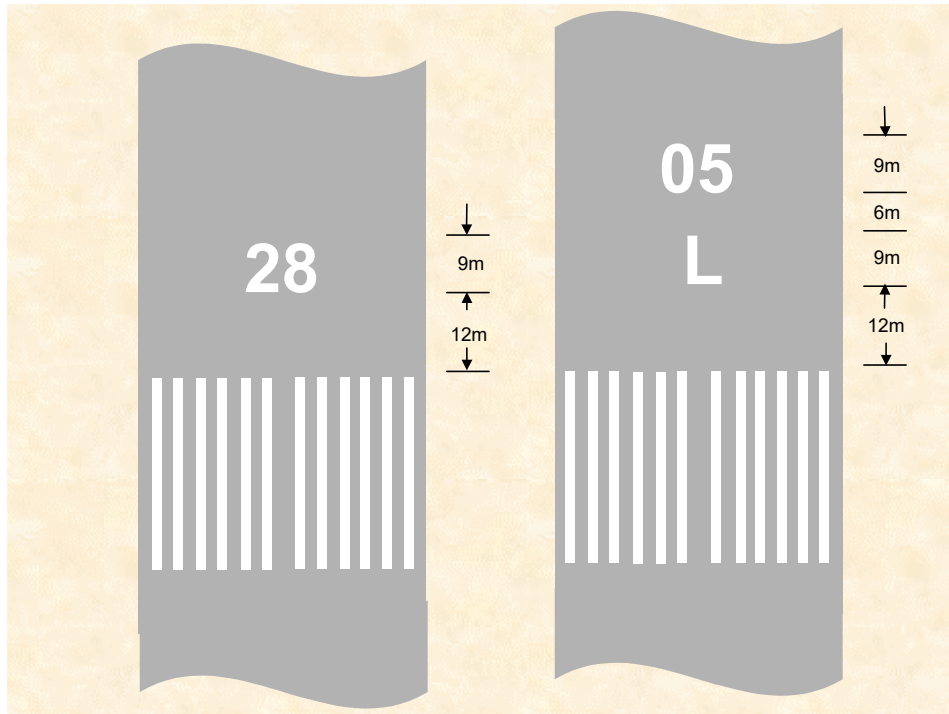
## 8.18 Runway designation markings

- (1) Runway designation markings must be provided:
  - (a) at the thresholds of all sealed, concrete or asphalt runways; and
  - (b) at the thresholds of an unsealed runway with sealed, concrete or asphalt thresholds.
- (2) A runway designation marking must consist of a 2-digit number that is:
  - (a) derived from the magnetic bearing of the runway centreline when viewed from the direction of approach; and
  - (b) rounded to the nearest 10 degrees.
- (3) If a magnetic bearing becomes a single-digit number, a “0” must be placed before it.
- (4) If a magnetic bearing becomes a 3-digit number, the last “0” digit must be omitted.  
*Note* For example, a bearing of 353 degrees would be rounded to 350, and the 0 omitted.
- (5) For parallel runways, each runway designation number must be supplemented by a letter which, when viewed from the direction of the approach, appears in the order from left to right as set out in Table 8.18 (5).

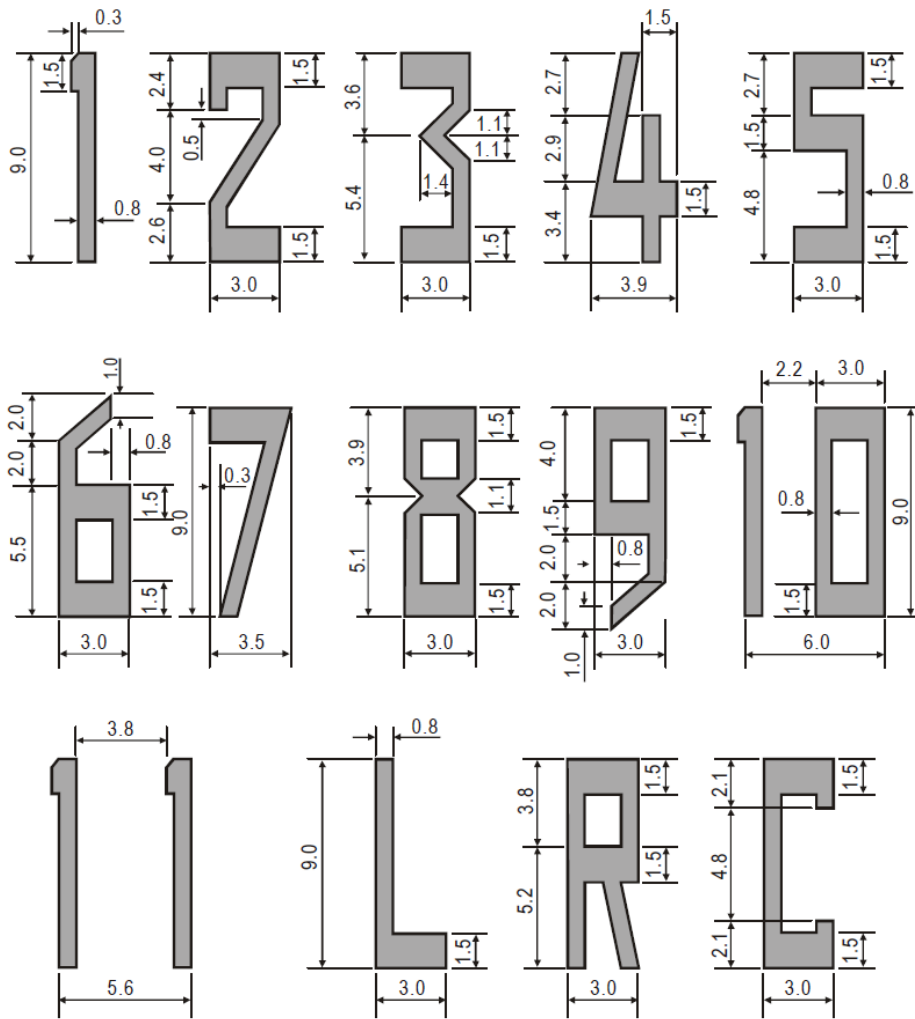
**Table 8.18 (5) Parallel runway letters and their order when viewed from the direction of the approach**

Number of parallel runways	Runway letters and their order
2	L (left) and R (right)
3	L, C (centre) and R
4	L, R, L and R
5	L, C, R, L and R
6	L, C, R, L, C and R

- (6) The location and orientation of runway designation markings on a runway must be as shown in Figure 8.18 (6).
- (7) The distance from the threshold marking to the corresponding runway designation marking must be 12 m.
- (8) The shape and dimensions of the numbers and letters to be used as runway designation markings must be as shown in Figure 8.18 (8).
- (9) Subject to subsection (10), each number or letter used in the runway designation marking must be 9 m in height.
- (10) The numbers “6” and “9” must be 9.5 m in height, but this does not affect any other spacing shown in Figure 8.18 (8).
- (11) For a runway designation marking used on a parallel runway, the distance between the runway designation number and the corresponding letter (L, C or R) must be 6 m.



**Figure 8.18 (6) Runway designation markings (shows matters)**



**Figure 8.18 (8) Shape and dimensions of runway numbers and letters (in metres) (shows matters)**

### 8.19 Runway centreline markings

- (1) Subject to subsection (2), runway centreline markings must be provided on all sealed, concrete or asphalt runways to provide directional guidance during landing or take-off.
- (2) For an 18 m wide sealed, concrete or asphalt runway, runway centreline markings may be omitted if runway side-stripe markings are provided.

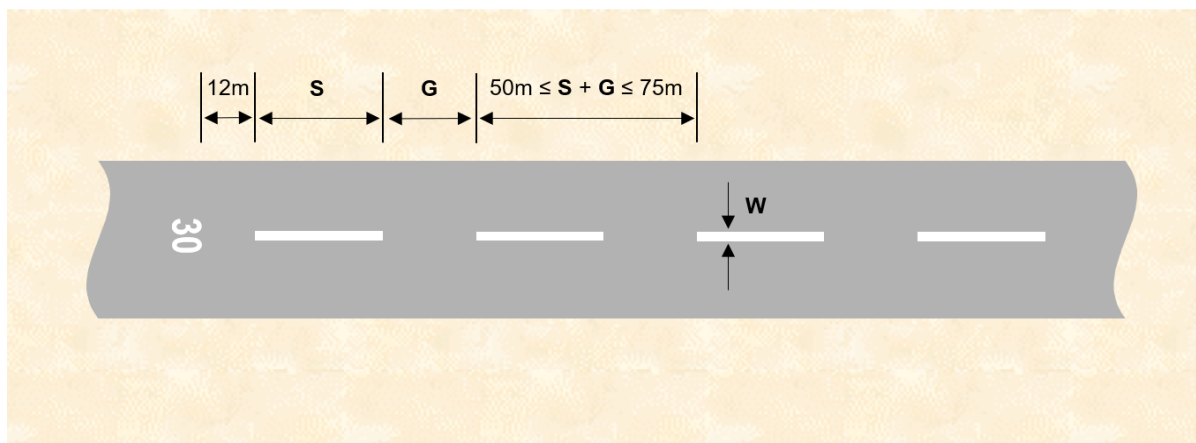
*Note* See also subsection 8.21 (3).

- (3) Runway centreline markings must consist of a line of uniformly-spaced white stripes, in which the stripes are each of equal length, and the gaps between the stripes are each of equal length, using lengths which, when the line is in place, are in accordance with subsection (4).

*Note* See Figure 8.19 (3).

- (4) The combined length of a stripe (**S**) and a gap (**G**) must not be less than 50 m and not more than 75 m.
- (5) The length of each stripe must be at least equal to whichever is greater of the following:
  - (a) the length of each gap;
  - (b) 30 m.

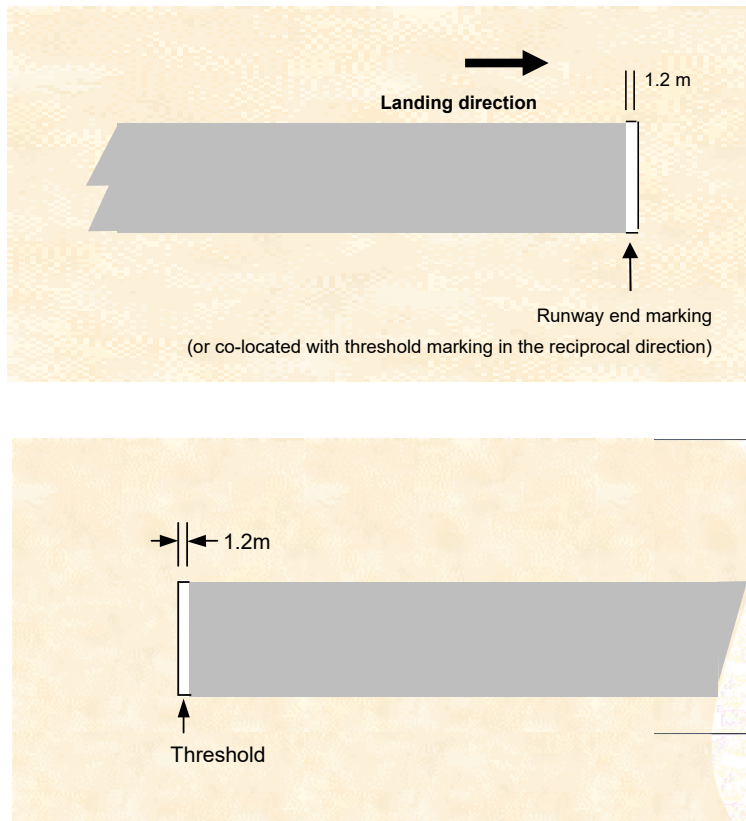
- (6) The first stripe must commence 12 m from the runway designation number as shown in Figure 8.19 (3).
- (7) The width ( $W$ ) of the runway centreline marking must not be less than:
  - (a) 0.3 m for:
    - (i) non-instrument runways; and
    - (ii) code 1 or 2 instrument non-precision approach runways; and
  - (b) 0.45 m for:
    - (i) code 3 or 4 instrument non-precision approach runways; and
    - (ii) CAT I precision approach runways; and
  - (c) 0.9 m for:
    - (i) CAT II and CAT III precision approach runways; and
    - (ii) runways with an RVR of less than 550 m for take-off.



**Figure 8.19 (3) Runway centreline markings (shows matters)**

## 8.20 Runway end markings

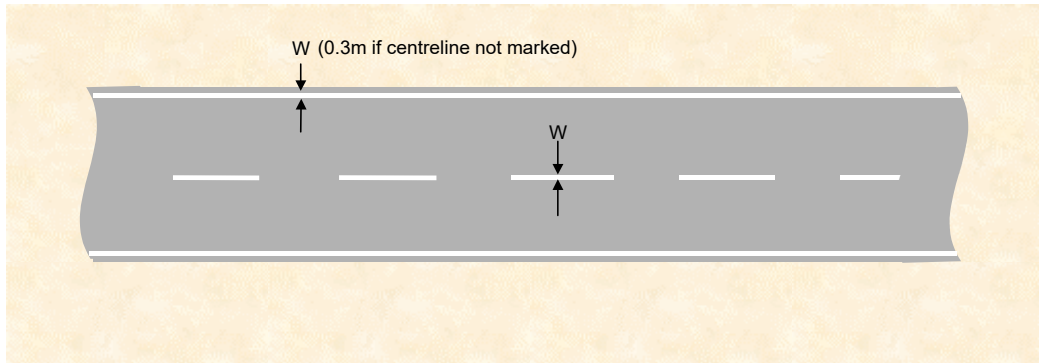
- (1) Runway end markings must:
  - (a) be provided at the end of all sealed, concrete or asphalt runways, as shown in Figure 8.20 (1); and
  - (b) take the form of a white line, 1.2 m wide, extending the full width of the runway at the declared end of the landing distance available.
- (2) If the threshold is also located at the end of the runway, the runway end marking must coincide with the corresponding part of the threshold marking in the reciprocal runway direction.



**Figure 8.20 (1) Runway end markings (shows matters)**

## 8.21 Runway side-stripe markings

- (1) Subject to subsection (7), a runway side-stripe marking must be provided along each side edge of a sealed, concrete or asphalt runway to delineate the width of the runway, as illustrated in Figure 8.21 (1).
- (2) Except where broken for taxiways and other runways, the runway side-stripe markings must consist of 1 continuous white line whose width is not less than that of the runway centreline marking.
- (3) Despite subsection (2), for an 18 m wide runway with no runway centreline marking, the width of the runway side-stripe marking must not be less than 0.3 m.
- (4) The distance between the outer edges of the runway side-stripe markings must be equal to the width of the runway.
- (5) The runway side-stripe markings must be parallel to the runway centreline and extend the full length of the runway that is between the runway end markings.
- (6) Runway side-stripe markings must not extend across runways or taxiways that intersect with the runway.
- (7) If:
  - (a) a runway has no sealed shoulders; and
  - (b) there is distinct contrast between the runway edges and the surrounding terrain;
 then the runway side-stripe markings may be omitted.



**Figure 8.21 (1) Runway side-stripe markings (illustrates matters)**

## 8.22 Aiming point markings

- (1) An aiming point marking:
  - (a) must be provided at each approach end of a runway that is:
    - (i) sealed, concrete or asphalt; and
    - (ii) at least 30 m wide and at least 1 500 m long; and
  - (b) may be provided at the approach end of any other runway.

*Note* CASA recommends that an aiming point marking should be provided at each approach end of each sealed, concrete or asphalt instrument runway even if the runway is less than 30 m wide, or less than 1 500 m long.

- (2) Aiming point markings must comply with the standards in this section, and in sections 8.23, 8.24 and 8.25.

### Precision approach runway

- (3) For a precision approach runway, the aiming point marking must consist of 2 conspicuous stripes whose location and dimensions are in accordance with Table 8.22 (3).
- (4) For Table 8.22 (3), the aiming point marking must be located not more than the distance from the threshold that is mentioned in Row A of the column that is for the landing distance available.
- (5) Subject to subsection (6), for Table 8.22 (3), the length, the width, and the lateral spacing between the inner sides, respectively, of each stripe of the aiming point marking must be the length, the width and the lateral spacing mentioned in Row B, Row C and Row D, respectively, of the column that is for the landing distance available.
- (6) For Table 8.22 (3), the superscript letters “a” and “c” included against certain values in the Table have the following meaning:
  - (a) *a* means that the greater dimension of the specified range may be used if increased conspicuity is required;
  - (b) *c* means that the lateral spacing may be varied within the limits mentioned to minimise the contamination of the marking by rubber deposits.

*Note* For superscript letter *b*, the figures were deduced by reference to the outer main gear wheel span which is element 2 of the ARC.

- (7) Despite subsections (3) and (4), on a runway with a VASIS, the beginning of the aiming point marking must coincide with the origin of the visual approach slope.

**Table 8.22 (3) Precision approach runway — location and dimensions of aiming point marking**

Location and dimensions of aiming point marking	Landing distance available			
	Less than 800 m	800 m up to, but not including, 1 200 m	1 200 m up to, but not including, 2 400 m	2 400 m and above
Row A Distance from threshold to beginning of marking <i>Note</i> For a runway with a VASIS, see subsection 8.22 (7).	150 m	250 m	300 m	400 m
Row B Length of marking stripe <sup>a</sup>	30-45 m	30-45 m	45-60 m	45-60 m
Row C Width of marking stripe	4 m	6 m	9 m	9 m
Row D Lateral spacing between inner sides of marking stripes	6 m <sup>b</sup>	9 m <sup>b</sup>	18-23 m <sup>c</sup>	18-23 m

**Non-precision approach runway**

- (8) For a non-precision approach runway, or a non-instrument runway, the aiming point marking must comply with:
- (a) the relevant precision approach runway standard in Table 8.22 (3); or
  - (b) the following:
    - (i) the marking must consist of 2 conspicuous stripes, each 45 m in length, each having a width (**W**), and each with inside edges separated by a distance (**D**), such that for a runway width mentioned in a row of column 1 of Table 8.22 (8), **W** and **D**, respectively, are as mentioned in the same row of column 2 and 3, respectively;
    - (ii) the ends of the stripes nearest the threshold must be located at 300 m from the line of the runway threshold.

*Note* For runways with a VASIS, CASA recommends that aiming point markings should be provided to the relevant precision approach runway standard.

**Table 8.22 (8) Non-precision approach runway — aiming point marking stripes**

Runway width	<b>W</b>	<b>D</b>
30 m	6 m	17 m
45 m or more	9 m	23 m

**8.23 Touchdown zone markings**

- (1) A touchdown zone marking must be provided at each end of a sealed, concrete or asphalt runway that is at least 30 m wide and at least 1 500 m long.

*Note* CASA recommends that a touchdown zone marking be provided at both ends of other sealed, concrete or asphalt runways.

- (2) The touchdown zone marking must comply with the following pattern:
  - (a) on a precision approach runway — the ICAO “A” – basic pattern, in accordance with section 8.24;
  - (b) on other runways:
    - (i) the ICAO “A” – basic pattern; or
    - (ii) the simple pattern.

## **8.24 Touchdown zone markings – ICAO “A” – basic pattern**

- (1) The ICAO “A” – basic pattern touchdown zone marking must consist of pairs of white rectangular markings symmetrically disposed about the runway centreline.
- (2) As shown in Figure 8.24 (2)-1, with further examples shown in Figure 8.24 (2)-2, each ICAO “A” – basic pattern touchdown zone marking must:
  - (a) be 22.5 m long and 3 m wide; and
  - (b) have a lateral spacing between the inner sides of the rectangles equal to that of the aiming point markings.
- (3) Subject to subsections (4) and (5), the numbers and locations of pairs of touchdown zone markings must be in accordance with Table 8.24 (3) such that for an item in a row of column 2 of the Table, the numbers of pairs and the location of each pair, respectively, are the numbers and the locations mentioned in the same row in columns 3 and 4, respectively.
- (4) If the number of pairs in column 3 of Table 8.24 (3) has a superscript letter “a”, the touchdown zone marking within 50 m of the aiming point marking must be omitted.
- (5) There must be a 550 m zone, located symmetrically about the midpoint of the runway length, where no touchdown zone markings are marked.
- (6) A pair of touchdown zone markings corresponding from each runway end that would otherwise fall within the 550 m zone mentioned in subsection (5) must be omitted.

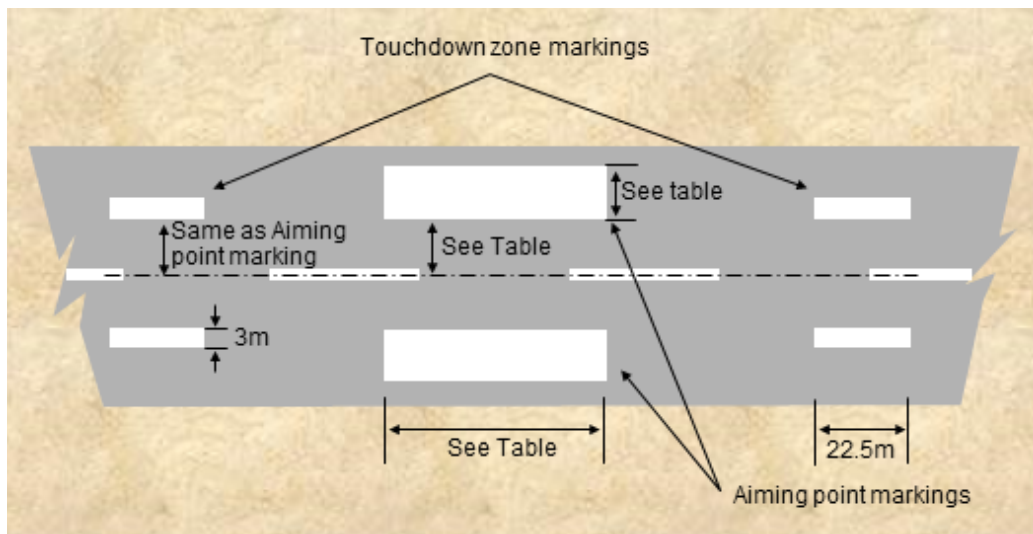
*Note* The intent of this marking practice is to preserve a 550 m unmarked area so that pilots do not confuse the surface markings during a landing with the surface markings originating from the opposite runway end.



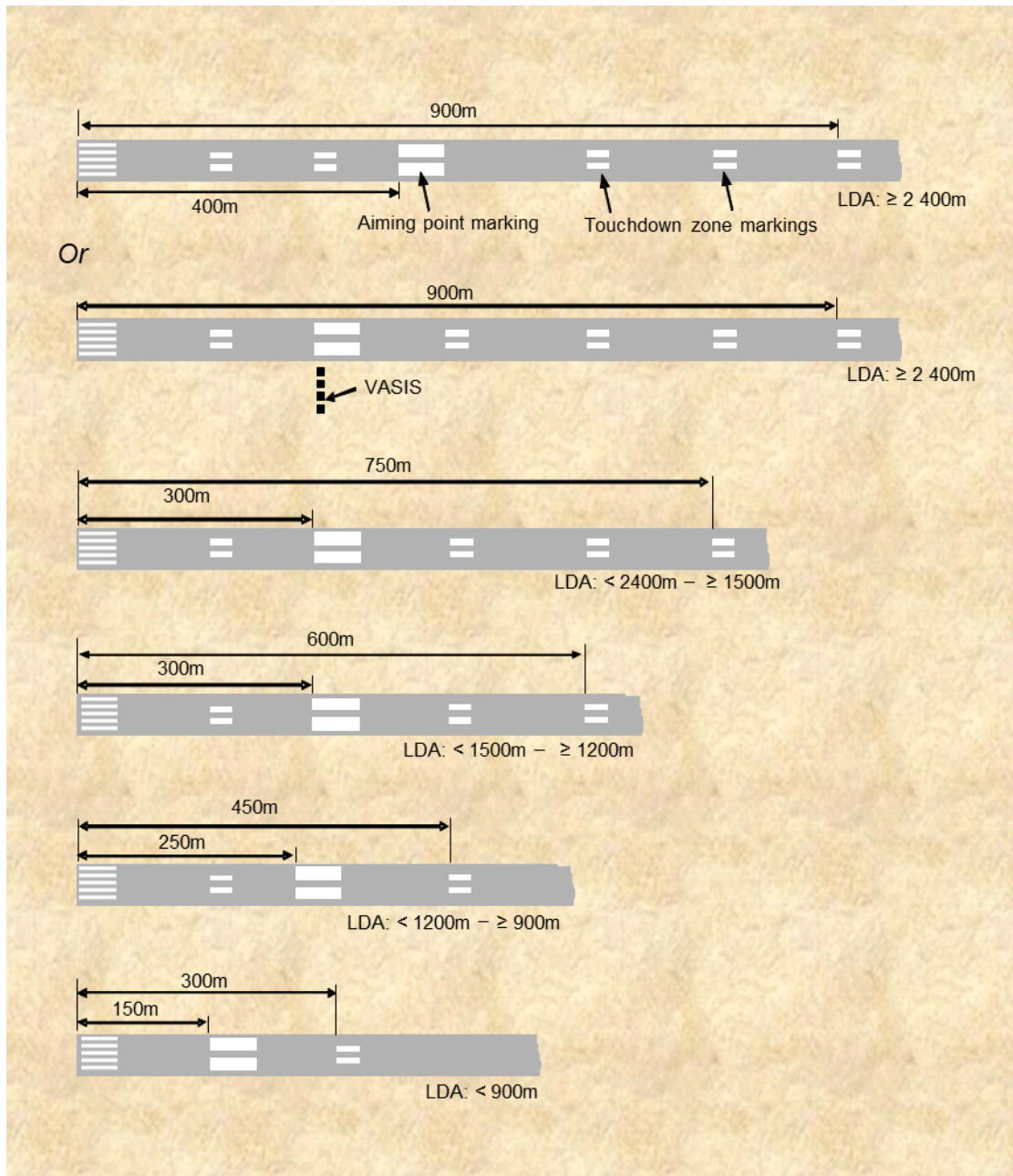
**Table 8.24 (3) Pairs of rectangular markings for ICAO “A” – basic pattern touchdown zone marking**

Item	Landing distance available, or the distance between thresholds (if the touchdown zone marking is displayed at both of the approach directions)	Numbers of pairs of touchdown zone markings	Location of each pair of touchdown zone markings (distance in metres from threshold)
1	less than 900 m	1	300
2	900 m up to, but not including, 1 200 m	2	150 and 450
3	1 200 m up to, but not including, 1 500 m	3 <sup>a</sup>	150, 300, 450 and 600
4	1 500 m up to, but not including, 2 400 m	4 <sup>a</sup>	150, 300, 450, 600 and 750
5	2 400 m or more	5 <sup>a</sup>	150, 300, 450, 600, 750 and 900

*Note* The provision of aiming point markings may require 1 pair of touchdown zone markings to be omitted. As a result, for the Table, the numbers of pairs of touchdown zone markings do not necessarily align with the numbers of locations.



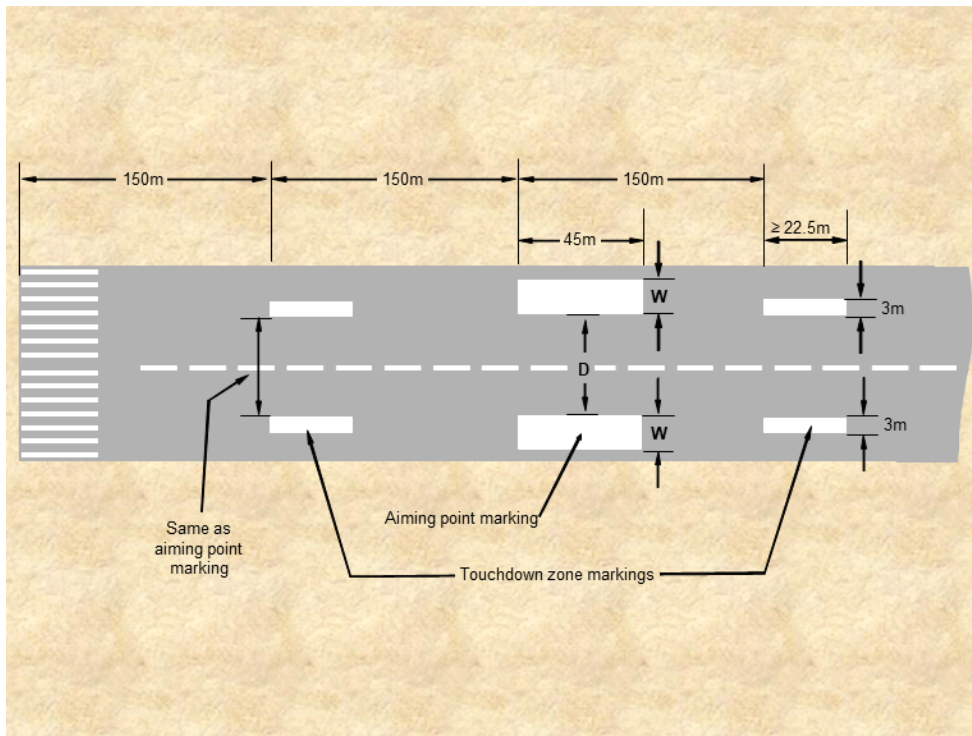
**Figure 8.24 (2)-1 Aiming point and ICAO “A” – basic pattern touchdown zone markings – dimensions (shows matters)**



**Figure 8.24 (2)-2 Aiming point and ICAO “A” – basic pattern touchdown zone markings – examples (shows matters)**

## 8.25 Touchdown zone markings — simple touchdown pattern

- (1) As shown in Figure 8.25 (1), a simple touchdown zone marking must comprise 4 white stripes, each not less than 22.5 m long and 3 m wide, located in pairs such that the ends of each pair of stripes nearest the threshold are 150 m and 450 m, respectively, from the line of the runway threshold. The lateral spacing between the inner sides of each pair of markings must be equal to that of the aiming point marking.
- (2) If simple runway touchdown zone markings are provided on a runway that is less than 1 500 m in length, the markings at 450 m from the end of the runway threshold may be omitted.



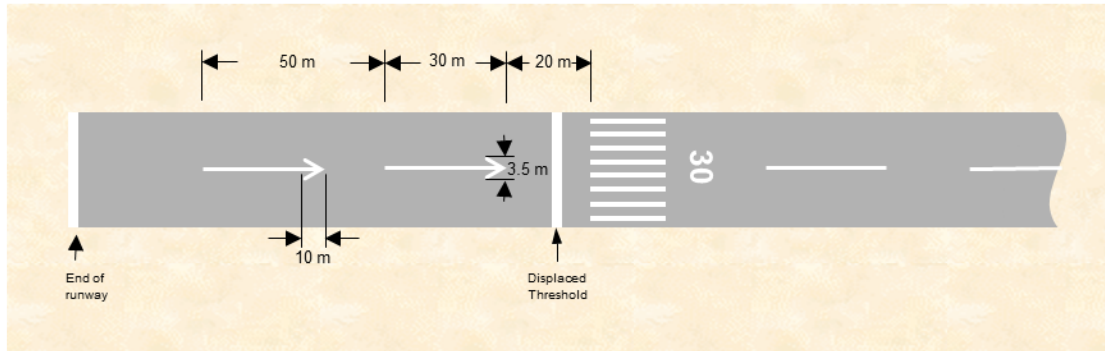
**Figure 8.25 (1) Aiming point and simple touchdown zone markings (shows matters)**

## 8.26 Permanently displaced threshold markings

- (1) If a runway threshold is permanently displaced, permanently displaced threshold markings must be provided as shown in Figures 8.26 (1)-1 and 8.26 (1)-2.
- (2) The markings must take the form of a sequence of 30 m long white arrows as follows:
  - (a) the first arrow must point in the direction of the displaced threshold;
  - (b) the tip of the head of the first arrow must end 20 m from the commencement of the displaced threshold's white "piano key" markings;
  - (c) preceding complete arrows, pointing in the direction of the displaced threshold, must be provided at 20 m intervals until the reciprocal runway end is reached;

*Note* A partial arrow must not be used if there is insufficient space at the reciprocal runway end for a complete arrow.

- (d) the head of each arrow must:
  - (i) be 10 m long with a line thickness of between 0.9 m and 1 m; and
  - (ii) have arms that are 3.5 m apart at their widest dimension; and
  - (iii) commence from the end of the stem with the tip of the arrowhead pointing towards the displaced runway threshold; and
- (e) the stem of each arrow must be 30 m long and the same width as the centreline marking;
- (f) the combined length of the arrowhead, the arrow stem and the gap between the base of the arrow and the head of the preceding arrow must be 50 m.

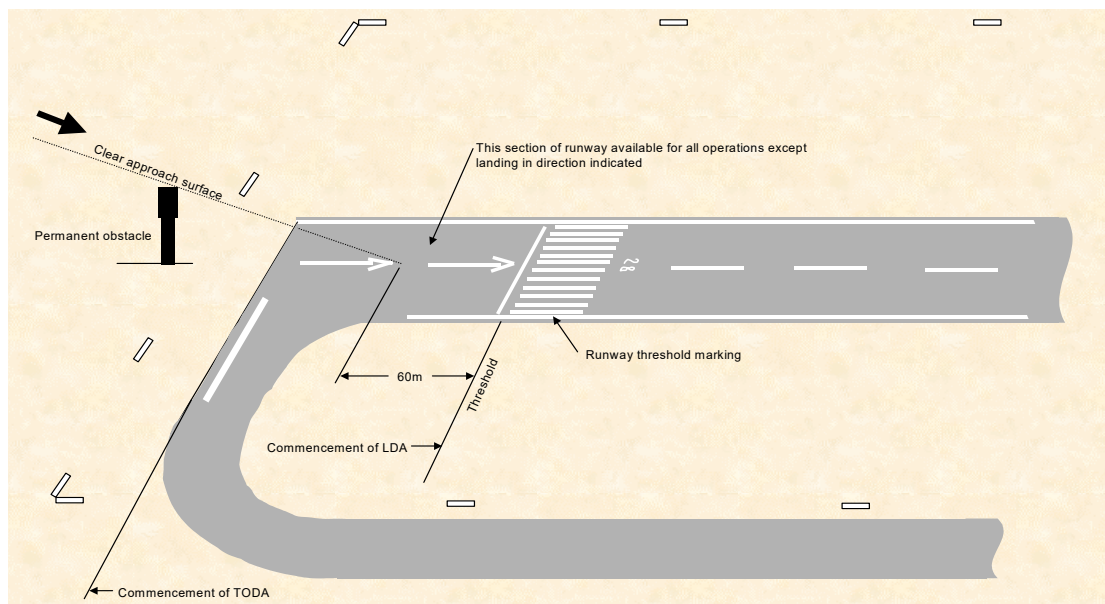


**Figure 8.26 (1)-1 Permanently displaced threshold markings (shows matters)**

- (3) If a threshold on any runway serving scheduled international air transport operations is permanently displaced, in addition to markings, the location of the new threshold may be identified with runway threshold identification lights (*RTIL*).

*Note 1* RTIL are also recommended where increased conspicuity of the permanently displaced threshold is required on runways not serving scheduled international air transport operations, and on runways serving international air transport operations not to a schedule.

*Note 2* If RTIL are provided, CASA recommends that they should not be used with other strobing lead-in light systems to avoid conflict. In such cases, the strobing lead-in light systems should be deactivated during the period the temporary displacement is in effect.



**Figure 8.26 (1)-2 Markings for a typical runway with a permanently displaced threshold (shows matters)**

## 8.27 Temporarily displaced threshold markings

*Note* If an instrument runway threshold is displaced, CASA recommends that the aerodrome operator should consult with the instrument flight procedure designer in relation to any published procedures for that runway.

- (1) Subject to subsection (2), if a permanent runway threshold is temporarily displaced, then temporarily displaced threshold markings must be provided.

- (2) If a threshold displacement will only occur during periods of night, then temporarily displaced threshold markings may be omitted, provided that:
- (a) visual aids in the form of lighting are operational for the displaced threshold with non-serviceable sections of the runway correctly isolated or obscured; and
  - (b) temporarily displaced threshold markers are available and able to be fully installed within 30 minutes of the beginning of morning civil twilight in the event of any delay to reinstatement of the threshold.
- (3) For an aerodrome with scheduled international air transport operations, if a threshold is temporarily displaced then RTIL must be provided at the displaced location (except for an emergency).

*Note* RTIL are also recommended for temporarily displaced thresholds on runways generally.

- (4) If:
- (a) a movement area guidance sign (**MAGS**) displays declared distance information; and
  - (b) because of a period of temporary threshold displacement the MAGS information is incorrect for the period;

the MAGS must be obscured until the permanent threshold is reinstated.

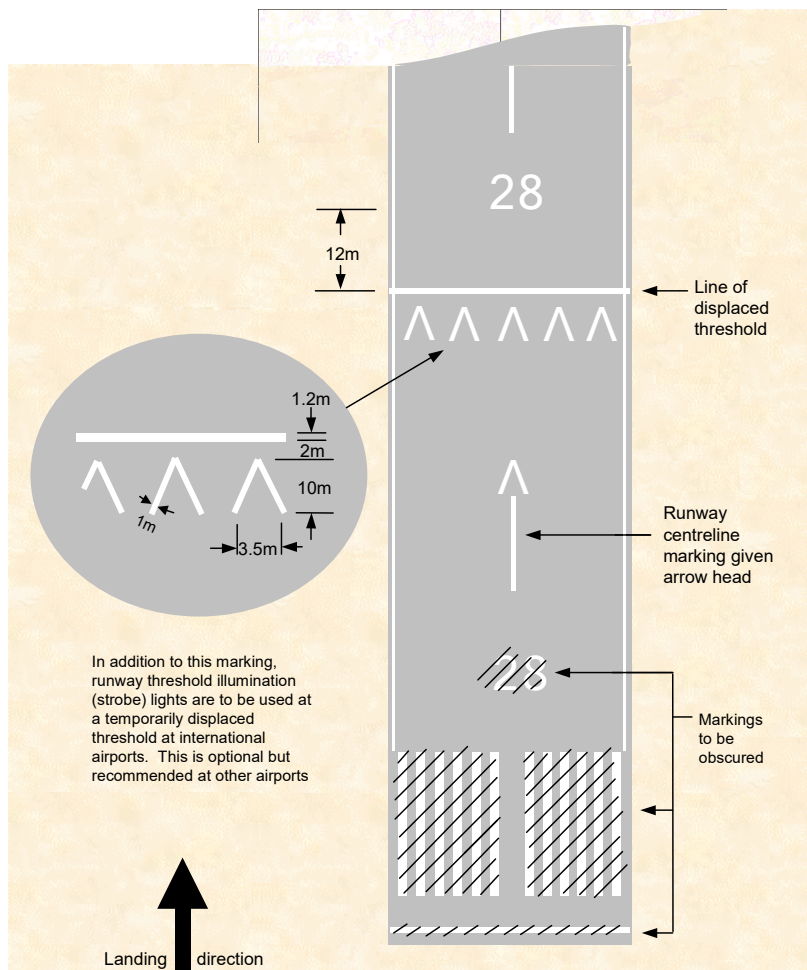
## **8.28 Temporarily displaced threshold markings — more than 30 days**

If a permanent runway threshold is to be displaced for more than 30 days, the temporarily displaced threshold markings must comply with the following:

- (a) a white line, that is 1.2 m wide, must be marked across the full width of the runway at the line of the new threshold, together with adjacent 10 m long white arrowheads, whose lines are 1 m wide;
- (b) existing centreline markings between the reciprocal runway end and the displaced threshold must be converted into arrows as shown in Figure 8.28;
- (c) the permanent threshold marking and associated runway designation number must be obscured, and a temporary runway designation number provided 12 m beyond the new threshold.

*Note 1* The existing centreline markings between the displaced threshold and the runway end do not need to be altered unless the temporary displacement is made permanent, in which case the requirements of section 8.26 would apply.

*Note 2* If the runway aiming point marking or the touchdown zone marking may cause confusion with the new threshold location, CASA recommends that those markings also be obscured.



**Figure 8.28 Temporarily displaced threshold markings (more than 30 days) (shows matters)**

## 8.29 Temporarily displaced threshold markings — more than 5 days to 30 days or less

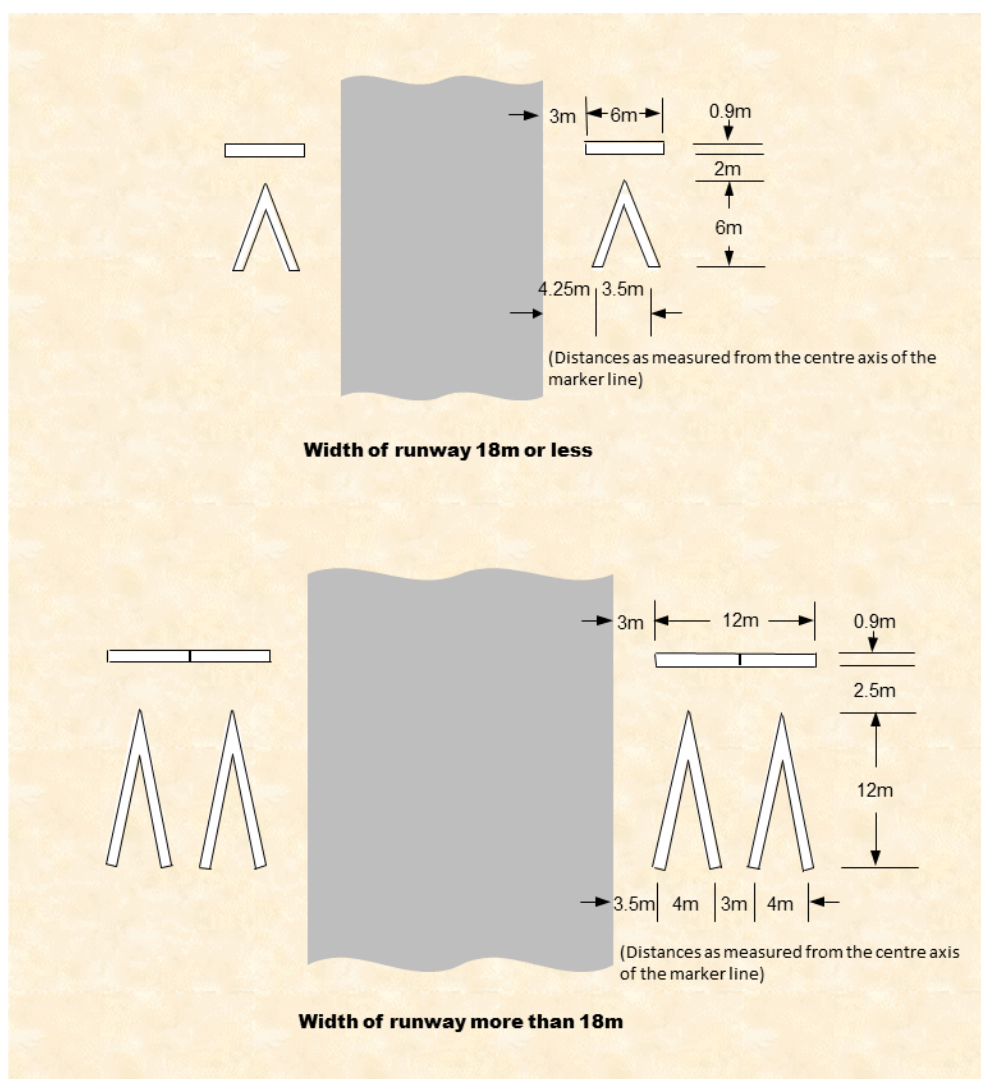
(1) If:

- (a) the permanent runway threshold is to be displaced for more than 5 days but not more than 30 days; and
- (b) the runway is not serving scheduled international air transport operations; and
- (c) RTIL are not provided in accordance with subsection 8.27 (3);

then the temporarily displaced threshold markings must consist of the following:

- (d) “Vee-bar” markers comprising gable markers coloured white and positioned perpendicular to the centreline on each side of the runway, together with flush, white arrow markings in the landing direction, as shown in Figure 8.29 (1);
- (e) for runways more than 18 m wide, or those serving air transport operations — 2 gable markers abutted end-to-end and positioned perpendicular to the centreline, and 2 arrow markings in the landing direction, must be provided on each side of the runway;
- (f) for runways that are 18 m wide and not serving air transport operations — a minimum of 1 gable marker positioned perpendicular to the centreline, and 1 arrow marking in the landing direction, must be provided on each side of the runway.

- (2) The existing threshold markings must be obscured.
- (3) If:
  - (a) the permanent runway threshold is to be displaced for more than 5 days but not more than 30 days; and
  - (b) the runway is serving scheduled international air transport operations;
 then the temporarily displaced threshold markings must be accompanied by RTIL in accordance with subsection 8.27 (3).



**Figure 8.29 (1) Temporarily displaced threshold markings for a runway not serving scheduled international air transport operations (30 days or less) (shows matters)**

### 8.30 Temporarily displaced threshold markings — 5 days or less

- (1) If a runway threshold is to be temporarily displaced for 5 days or less, the permanent threshold markings may be retained but the new threshold location must be indicated as follows:
  - (a) for runways serving scheduled international air transport operations — with RTIL only, in accordance with subsection 8.27 (3);

- (b) for all other runways:
  - (i) subject to subsection (2), with markers (*Vee-bar markers*) comprising gable markers coloured white and positioned on each side of the runway perpendicular to the centreline, together with flush, white arrow markings in the direction of landing, as shown in Figure 8.29 (1); or
  - (ii) with RTIL only, in accordance with subsection 8.27 (3);
- (2) For subparagraph (1) (b) (i):
  - (a) for runways that are more than 18 m wide, or runways serving air transport operations — there must be 2 Vee-bar markers on each side of the runway; and
  - (b) for runways that are 18 m wide and not serving air transport operations — there must be at least 1 Vee-bar marker on each side of the runway.

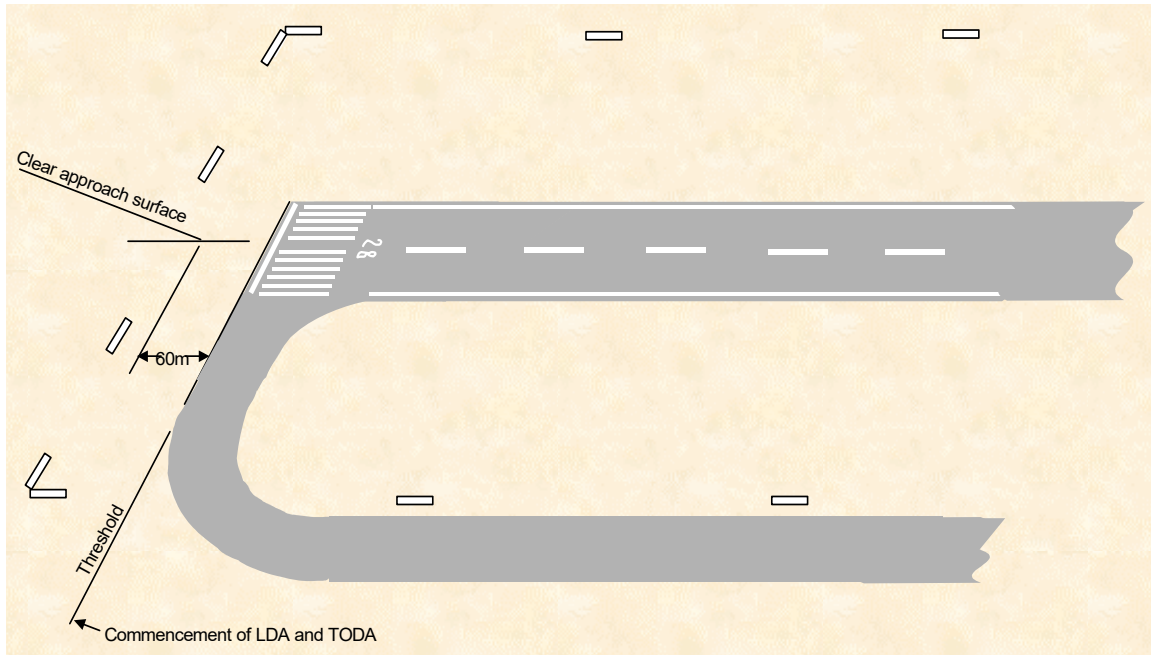
### **8.31 Temporarily displaced threshold markings — large displacements for 30 days or less**

- (1) Despite sections 8.29 and 8.30, if:
  - (a) a runway threshold is temporarily displaced for not more than 30 days; and
  - (b) the displacement is by more than 450 m; and
  - (c) RTIL are not provided;then temporarily displaced threshold markings must be provided in accordance with section 8.28.

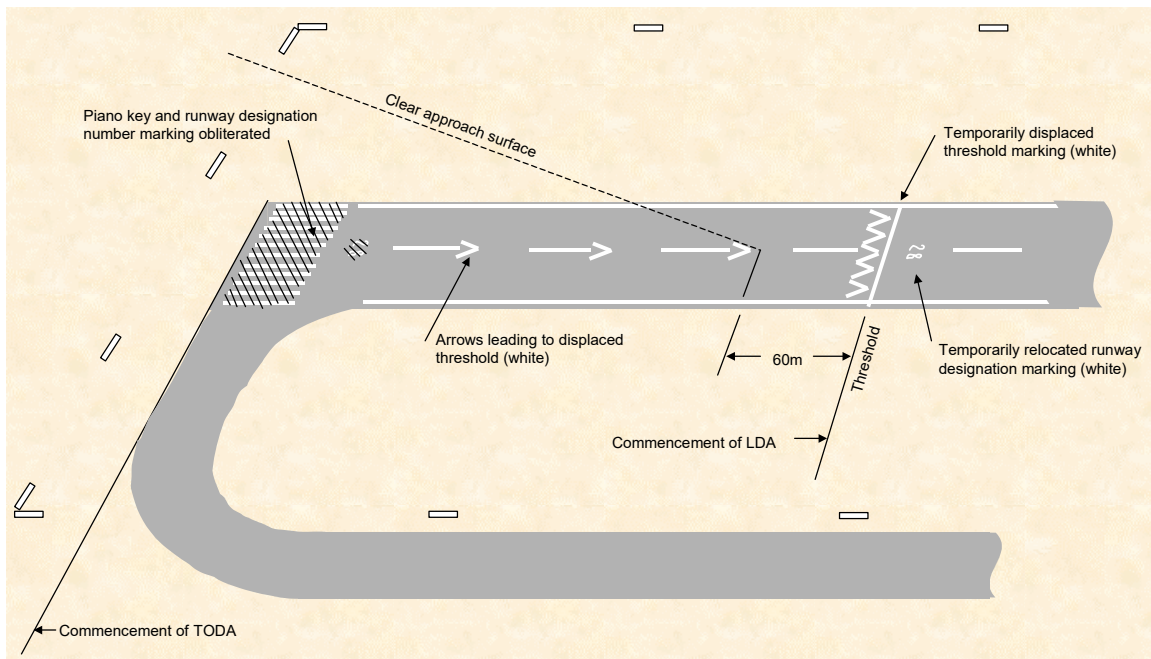
- (2) If:
  - (a) a threshold is temporarily displaced for not more than 5 days; and
  - (b) the displacement is by more than 450 m; and
  - (c) 24 hour ATC services are provided;then the permanent threshold markings may be retained if RTIL are provided.

*Note* Markings of some typical threshold and displaced threshold scenarios in Figures 8.31 (2)-1 to 8.31 (2)-5 are illustrations only.



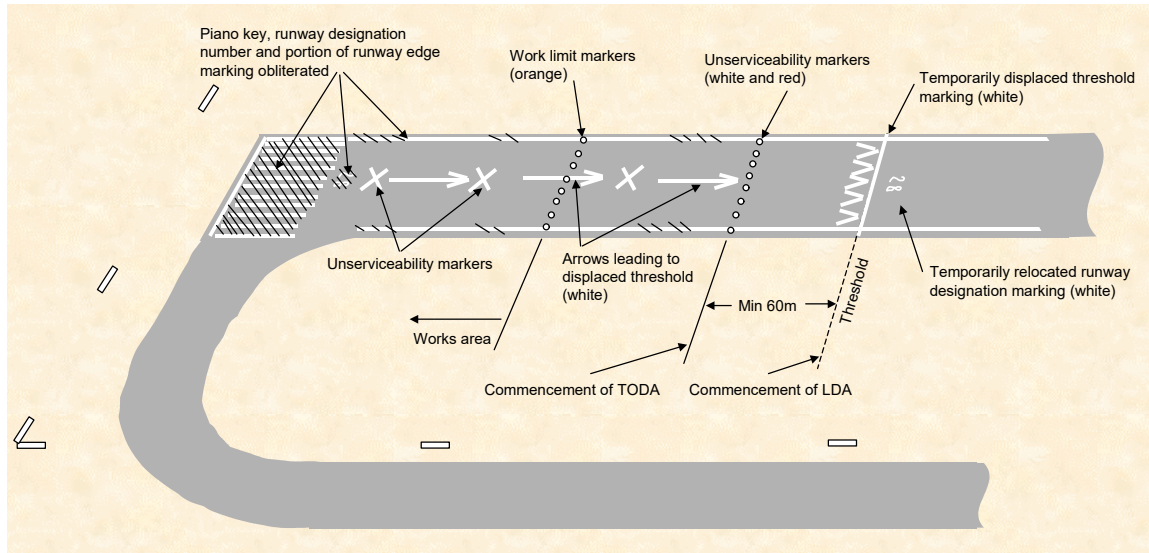


**Figure 8.31 (2)-1 Illustration of a normal threshold marking, not displaced (illustrates matters)**



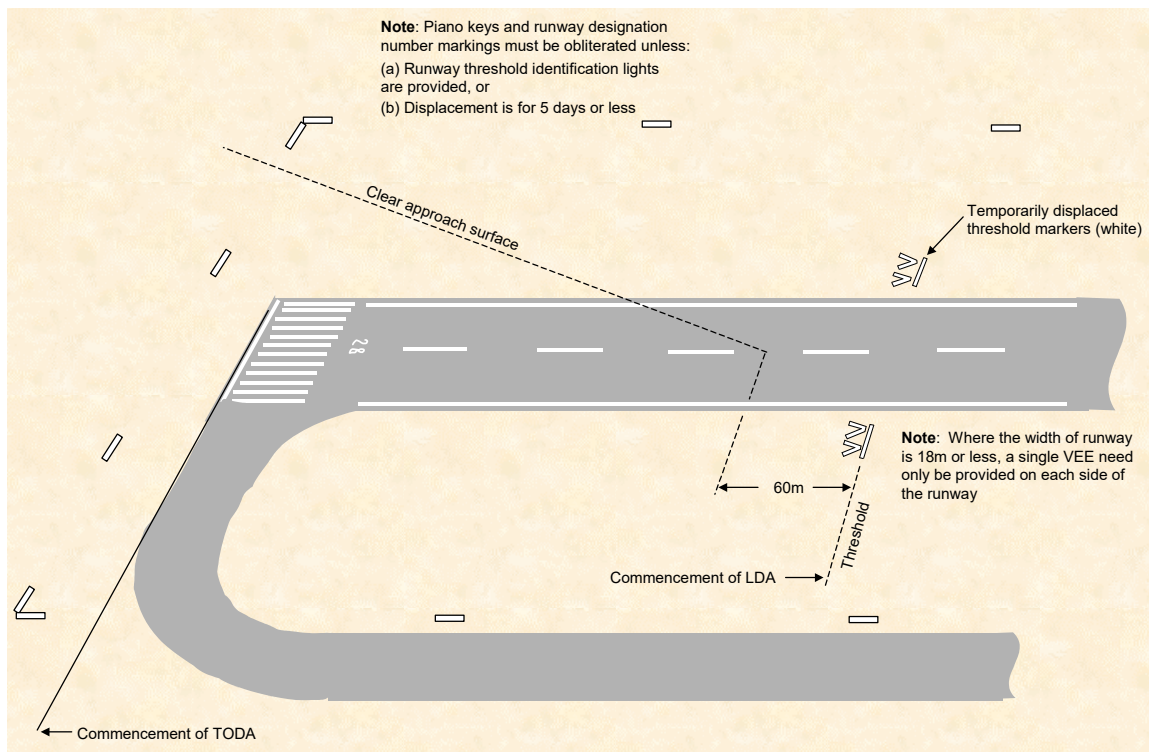
**Figure 8.31 (2)-2 Markings for a temporarily displaced threshold (due to obstacle infringement of the approach surface) for a period in excess of 30 days. Aerodromes with scheduled international air transport operations must also provide RTIL at the threshold (illustrates matters)**

*Note* Aerodromes with scheduled international air transport operations must also provide RTIL at the threshold.

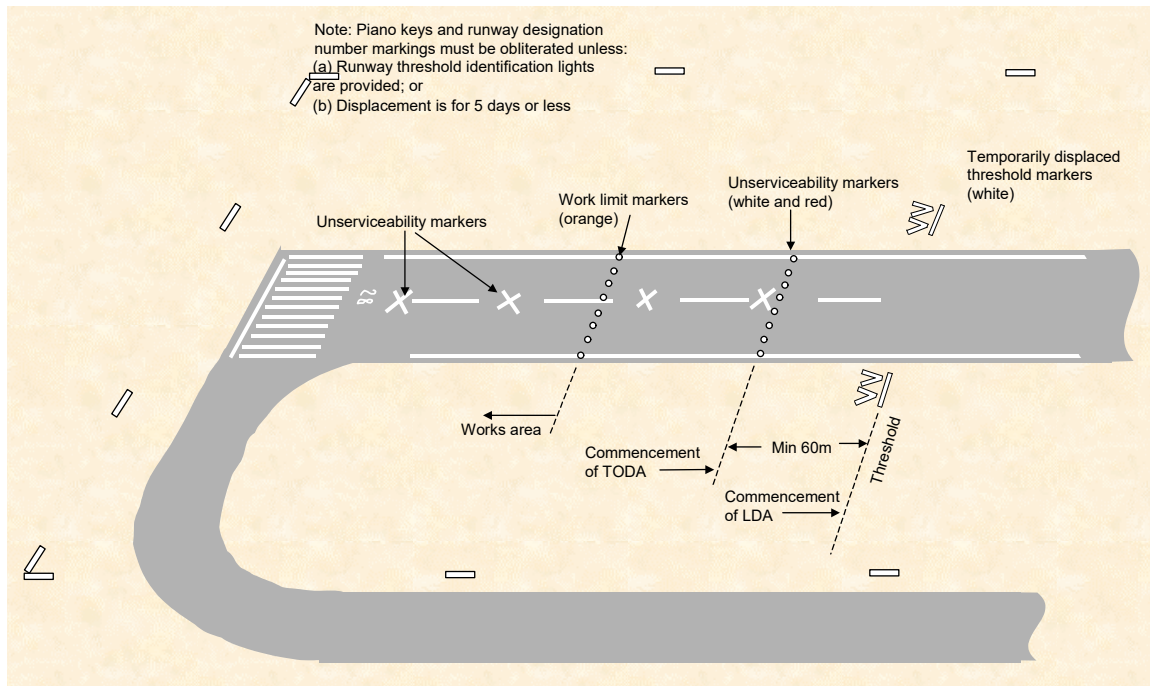


**Figure 8.31 (2)-3 Markings for a temporarily displaced threshold (due to works on the runway) for a period in excess of 30 days. Aerodromes with scheduled international air transport operations must also provide RTIL at the threshold (illustrates matters)**

*Note* Aerodromes with scheduled international air transport operations must also provide RTIL at the threshold.



**Figure 8.31 (2)-4 Markings for a temporarily displaced threshold (for example, due to obstacle infringement of approach surface) for a period of 5 days or less and a displacement of less than 450 m. Not for use on runways which serve scheduled international air transport operations (illustrates matters)**



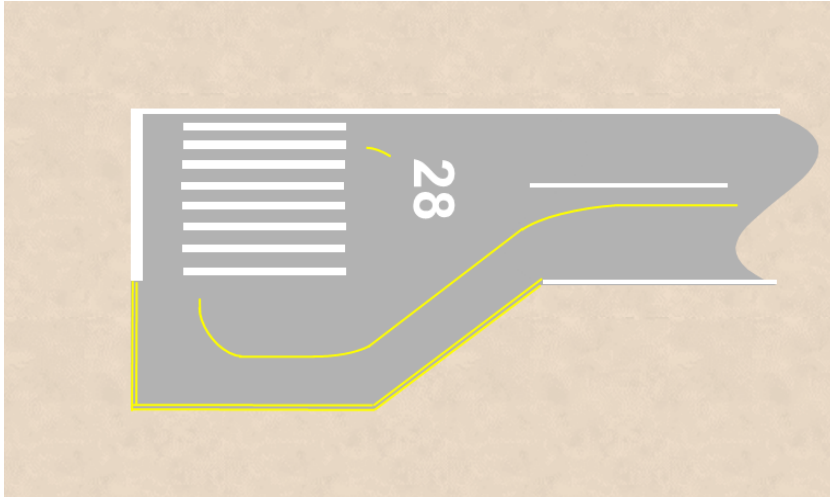
**Figure 8.31 (2)-5 Markings for a temporarily displaced threshold (for example, due to works in progress on runway) for a period of 5 days or less and a displacement of less than 450 m. Not for use on runways which serve scheduled international air transport operations (illustrates matters)**

### 8.32 Runway land and hold short position markings

- (1) At an aerodrome where land and hold short operations (**LAHSO**) are conducted, a runway land and hold short position marking must be provided at the intersection of 2 sealed runways.
- (2) The marking must be located and coloured in accordance with the runway holding position marking mentioned in section 8.39.

### 8.33 Runway turn pad markings

- (1) If a runway turn pad is provided, there must be a yellow runway turn pad marking, as illustrated in Figure 8.33 (1), but primary markings for the runway take precedence over a runway turn pad marking.
- (2) The centreline marking for the runway turn pad must comply with the specifications and dimensions of taxi guidelines as specified in this Chapter.
- (3) The runway turn pad centreline marking must extend beyond the point of tangency, running parallel to the runway centreline with a 0.9 m offset, for a distance of:
  - (a) 60 m for a code number 3 or 4 runway; and
  - (b) 30 m for a code number 1 or 2 runway.
- (4) The edge marking of the turning node must comply with the specifications and dimensions of taxiway edge markings as specified in section 8.43.



**Figure 8.33 (1) Runway turn pad markings (illustrates matters)**

### **8.34 Runway starter extension markings**

- (1) If additional declared distances are required for an aircraft to take off, a runway starter extension may be provided to make such additional runway distances available.
- (2) Any extension that is not of a runway bypass pad type must be marked with the following stripes of the same width as the runway side-stripe markings under section 8.21:
  - (a) runway side-stripe markings along each side of the extension;
  - (b) a runway end marking across the end of the extension.
- (3) The start of a runway starter extension before the threshold line must be marked by a transverse line with the same characteristics as the runway side-stripe marking.

*Note* Starter extensions are to be lit in accordance with the requirements specified in subsection 9.64 (3). Markings will likely resemble a permanently displaced threshold, as specified in section 8.26.

## CHAPTER 8

### Division 4 Taxiway markings

#### 8.35 Introduction

- (1) Taxiway markings must:
  - (a) be provided on all sealed, concrete or asphalt taxiways; and
  - (b) provide continuous guidance between the runway and the apron.

*Note* An apron may also need taxi guidelines marked under subsection 8.47 (1).

- (2) Taxiway markings must:
  - (a) be coloured yellow; and
  - (b) have a minimum line width of 0.15 m and a maximum line width of 0.3 m; and
  - (c) be continuous, unless this Division provides otherwise.

#### 8.36 Taxi guideline markings

- (1) Taxi guideline markings (*taxi guidelines*) must be provided on all sealed, concrete or asphalt taxiway surfaces.
- (2) Taxi guidelines must take the form of a continuous yellow line that is 0.15 m wide.
- (3) The taxi guideline must be located as follows:
  - (a) on straight sections of a taxiway — along the centreline of the taxiway;
  - (b) on curved sections of a taxiway:
    - (i) parallel to the outer edge of the pavement; and
    - (ii) at a distance of half of the taxiway width from the outer edge.

*Note* The effect of any fillet widening at the inner edge of a taxiway curve is ignored.

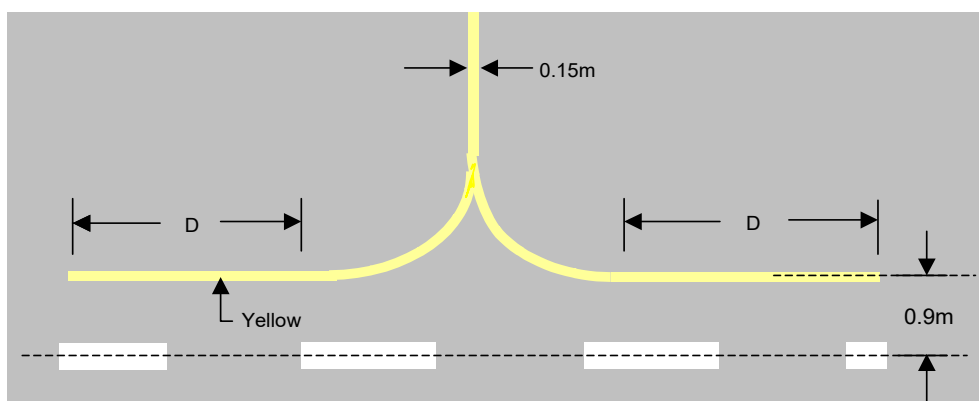
- (4) Despite subsection (3), a taxi guideline may be displaced to one side of the taxiway, to maintain the clearances specified in section 6.48, if the taxiway edge clearances specified in section 6.38 are achieved.
- (5) Unless otherwise specified in this MOS, where a taxi guideline marking is interrupted by another runway or taxiway marking that is not another taxi guideline, a gap of 0.9 m must be left on each side of the other marking.
- (6) Subsection (5) does not apply to a taxi guideline associated with a runway turn pad marking if the taxi guideline is required to intersect with a runway threshold (piano key) marking, a touchdown zone marking or an aiming point marking, provided that the taxiway guideline marking does not cross, or go in between any element of, the runway marking.

*Note* Taxi guidelines must be used on aprons. See Division 5 of this Chapter.

#### 8.37 Taxi guidelines on runways

- (1) Taxi guidelines on runways must not:
  - (a) merge with the runway centreline; or
  - (b) be marked over a runway marking.

- (2) As shown in Figure 8.37 (2), subject to subsection (3), a taxi guideline on a runway must run parallel to the runway centreline for a distance (D) not less than:
  - (a) for a code 3 or 4 runway — 60 m beyond the point of tangency to the curved section of the taxi guideline; or
  - (b) for a code 1 or 2 runway — 30 m beyond the point of tangency to the curved section of the taxi guideline.
- (3) Subsection (2) does not apply to a taxi guideline which, but for subsections (5) and (6), would:
  - (a) completely cross a runway; or
  - (b) enter a runway threshold.
- (4) If a taxiway intersects a runway, the taxi guideline must be offset by 0.9 m from the runway centreline marking on the taxiway side, as shown in Figure 8.37 (2).



**Figure 8.37 (2) Taxi guidelines meeting runway centreline markings (illustrates matters)**

- (5) For taxi guidelines that would otherwise require entry to the threshold of a runway, the guideline must terminate 0.9 m before the runway threshold marking.
- (6) Subject to subsection 8.15 (4), at a taxiway and runway intersection, the taxiway guideline must be marked across the runway.

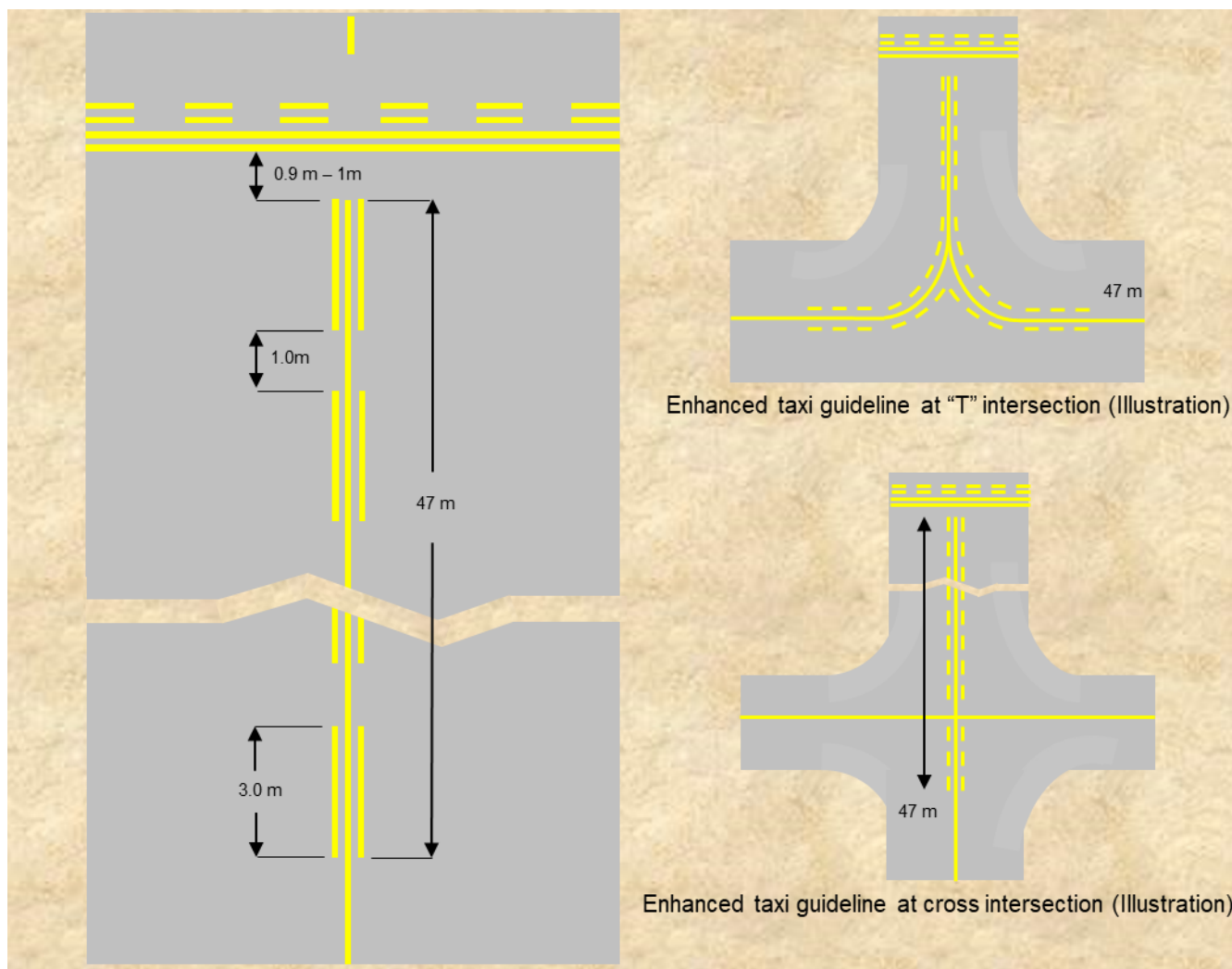
*Note* For precedence of taxiway versus runway markings, refer to subsection 8.15 (4).

### 8.38 Enhanced taxi guidelines

*Note* For runways at international aerodromes intended for operations below 550 m RVR or where it is otherwise necessary to denote the proximity of a runway holding position, the use of enhanced taxiway guidelines is recommended.

- (1) Enhanced taxiway centreline markings may be provided on a taxiway, or on a runway, before a runway hold position, as shown in Figure 8.38 (1).
- (2) Enhanced taxi guidelines must consist of parallel yellow dashed lines along each side of the centreline:
  - (a) commencing 0.9 m from the runway hold position; and
  - (b) continuing along the taxi guideline, away from the runway, for a distance of 47 m.

- (3) The dashed lines must be:
  - (a) 3 m long; and
  - (b) not less than 0.15 m, nor more than 0.3 m, wide; and
  - (c) 1 m apart.



**Figure 8.38 (1) Enhanced taxi guidelines (illustrates matters)**

### 8.39 Runway holding position markings

- (1) Runway holding position markings must be provided where an asphalt, sealed or concrete taxiway joins or intersects with a runway.
 

*Note* Standards for the location of runway holding positions are specified in Chapter 6, Division 3.
- (2) Subject to subsection (9), runway holding positions must be marked using the Pattern A or Pattern B runway holding position markings, as shown in Figure 8.39 (2).
- (3) The Pattern A marking must be used at an intersection of a taxiway with any of the following:
  - (a) a non-instrument runway;
  - (b) a non-precision approach runway;
  - (c) a precision approach CAT I runway;

- (d) a precision approach CAT II or CAT III runway if only 1 runway holding position is marked;
  - (e) the intersection of a runway with another runway, where 1 of the runways is used as part of a standard taxi route.
- (4) Pattern A and Pattern B markings must be used where 2 or 3 runway holding positions are provided at an intersection of a taxiway with a precision approach runway.
- (5) For subsection (4):
- (a) the runway holding position marking closest to the runway must be the Pattern A marking; and
  - (b) the other runway holding position marking or markings must be Pattern B.
- (6) Runway holding position markings must extend at least across the full width of the sealed taxiway surface.

*Note* If sealed shoulders are provided beyond the width of the taxiway, CASA recommends that the aerodrome operator mark the full width of the sealed surface beyond the taxiway to assist in preventing incursions by vehicles.

- (7) The position of a runway holding position marking must be such that, if the nose of an aircraft on the taxiway reaches the marking, the nose will not infringe on the relevant minimum distance specified in section 6.56 for the distance between a runway holding position and the centreline of the runway.

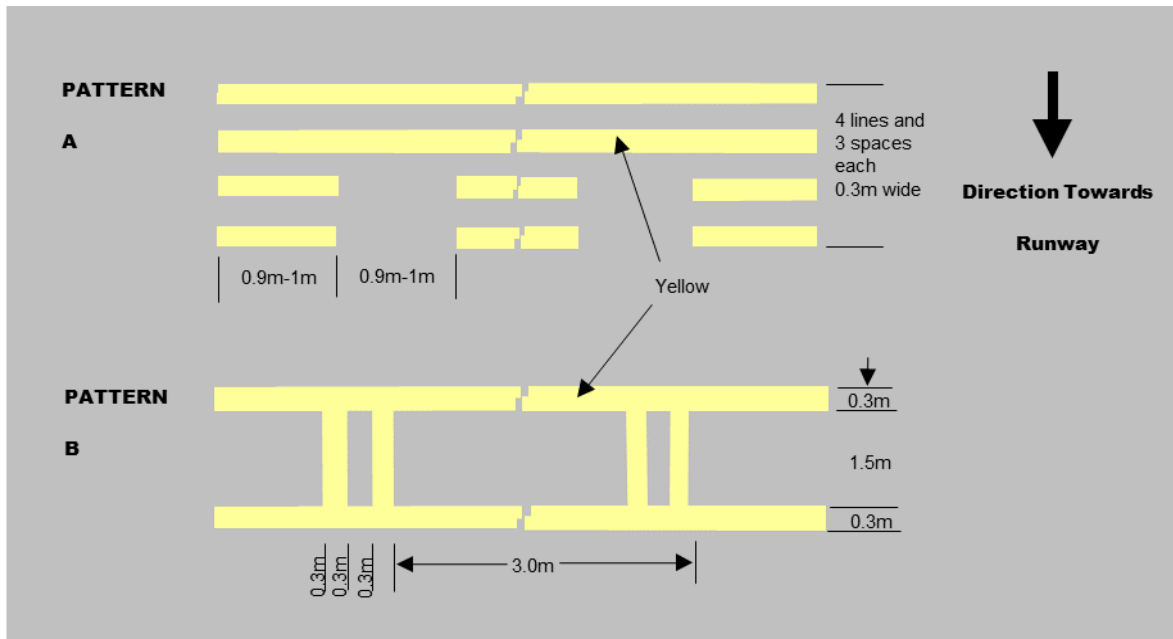
*Note* If inset taxiway guard lights are installed, the location of runway holding position markings may need to be adjusted away from the runway to ensure the light fittings can be correctly positioned and aligned with the required holding point position.

- (8) A taxiway guideline must be omitted from at least 0.9 m but not more than 1 m on each side of the runway holding position marking.
- (9) Subsection (2) applies to an existing operator only on and from the earlier of the following:
- (a) when the runway holding position is being re-marked (other than as simple maintenance merely to preserve its visibility) or replaced, or is a new facility that is being marked for the first time;
  - (b) 26 November 2026.

*Note 1* For the definition of existing operator, see section 2.01.

*Note 2* CASA recommends that, regardless of subsection (9), Pattern A or Pattern B markings, as shown in Figure 8.39 (2), should be implemented before 26 November 2026 where increased conspicuity of a runway holding position would assist with mitigating against runway incursions.





**Figure 8.39 (2) Pattern A and Pattern B runway holding position markings (shows matters)**

#### 8.40 Mandatory instruction markings

(1) Mandatory instruction markings may be used to:

- (a) mitigate runway incursions; or
- (b) supplement a mandatory instruction MAGS.

*Note* CASA recommends that mandatory instruction markings be provided at all taxiway and road entries to the runway.

(2) As illustrated in Figure 8.40 (2), for a code A, B, C or D taxiway, the mandatory instruction marking must be a single marking positioned as follows:

- (a) at least 0.9 m but not more than 1 m from the runway hold position marking;
- (b) across the alignment of, and taking the place of, the taxi guideline;

*Note* The mandatory instruction marking is a primary marking in this instance and takes the place of the taxi guideline.

(c) with the taxi guideline being omitted at least 0.9 m but not more than 1 m before the mandatory instruction marking.

(3) As illustrated in Figure 8.40 (2), for a code E or F taxiway, the mandatory instruction marking must be 2 markings positioned as follows:

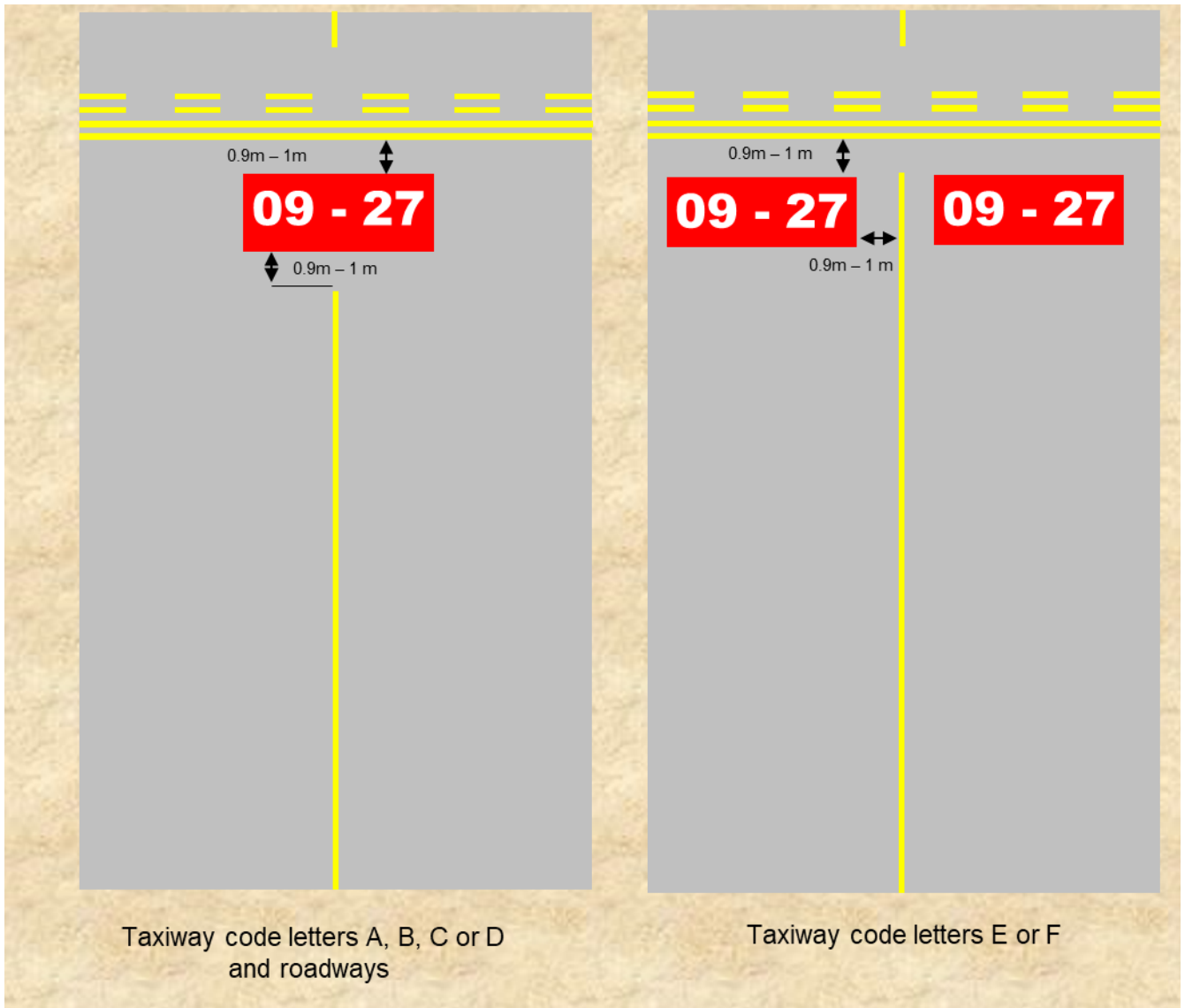
- (a) at least 0.9 m but not more than 1 m from the runway hold position marking;
- (b) on each side of the taxi guideline and offset by a distance of at least 0.9 m but not more than 1 m.

(4) A mandatory instruction marking must consist of an inscription in white on a red background.

(5) Character heights for a mandatory instruction marking must be:

- (a) 2 m — if the taxiway code letter is A or B; or

- (b) 4 m — if the taxiway code letter is C, D, E or F.
- (6) With the exception of a NO ENTRY marking, the inscription must provide information identical to that which would otherwise have appeared in a mandatory instruction MAGS for the taxiway.

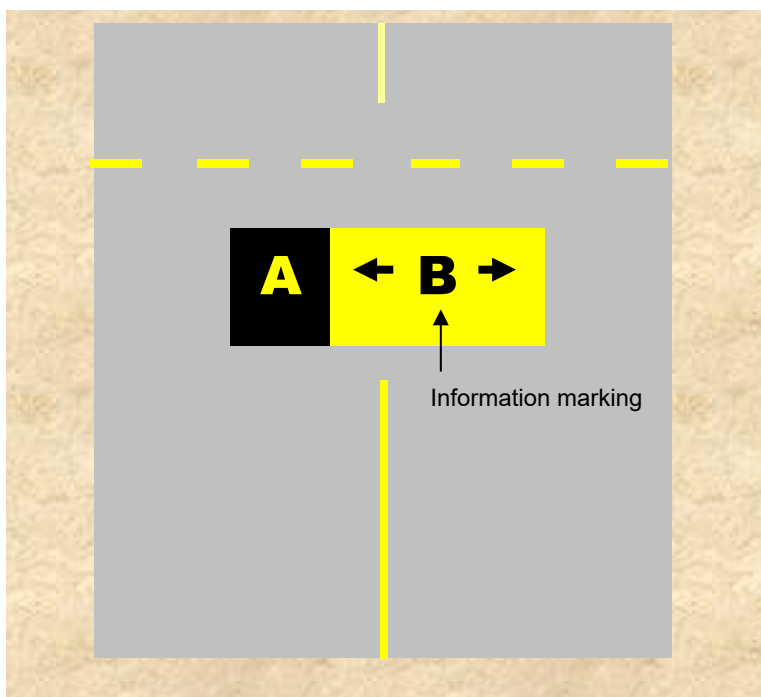


**Figure 8.40 (2) Mandatory instruction markings (illustrates matters)**

#### 8.41 Information markings

- (1) Information markings may be used:
  - (a) where it is physically impossible to provide an information MAGS; or
    - Note* The use of information markings in such circumstances is recommended.
  - (b) to supplement the use of an information MAGS.
    - Note* For MAGS see Division 6.
- (2) As illustrated in Figure 8.41 (2), when provided, an information marking must:
  - (a) have a character height of 4 m; and

- (b) if presenting a taxiway location — consist of a yellow inscription on a black background; and
- (c) if presenting a direction, destination, or take-off run available information — consist of a black inscription on a yellow background; and
- (d) be clearly readable by the pilot of an approaching aircraft; and
- (e) ensure the taxi guideline is omitted at least 0.9 m but not more than 1 m before the information marking.



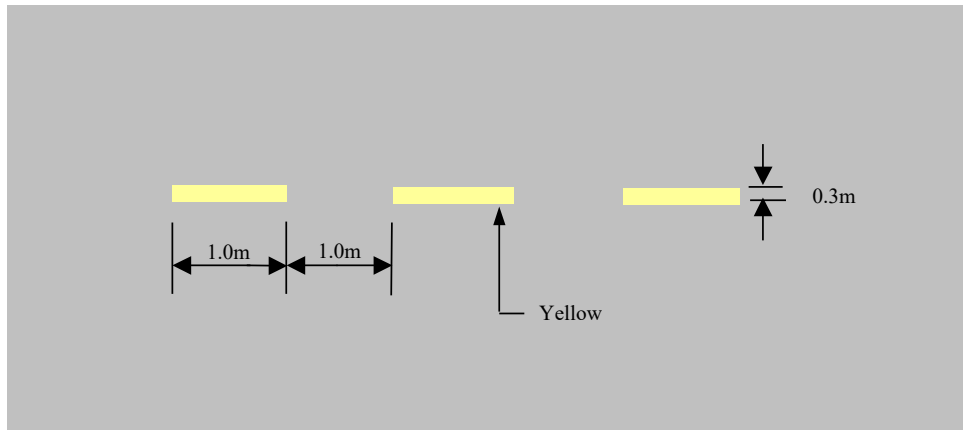
**Figure 8.41 (2) Information markings (illustrates matters)**

#### **8.42 Intermediate holding position markings**

- (1) At controlled aerodromes, intermediate holding position markings must be provided on a sealed, concrete or asphalt taxiway:
  - (a) that intersects with an apron or taxiway; or
  - (b) where ATC requires an aircraft to hold.

*Note* For the location of intermediate holding position markings, see the standards specified in Division 3 of Chapter 6.

- (2) As shown in Figure 8.42 (2), intermediate holding position markings must consist of a single yellow broken line, the dashes of which are 1 m long, 0.3 m wide and 1 m apart, extending across the full width of the taxiway at right angles to the taxi guideline.



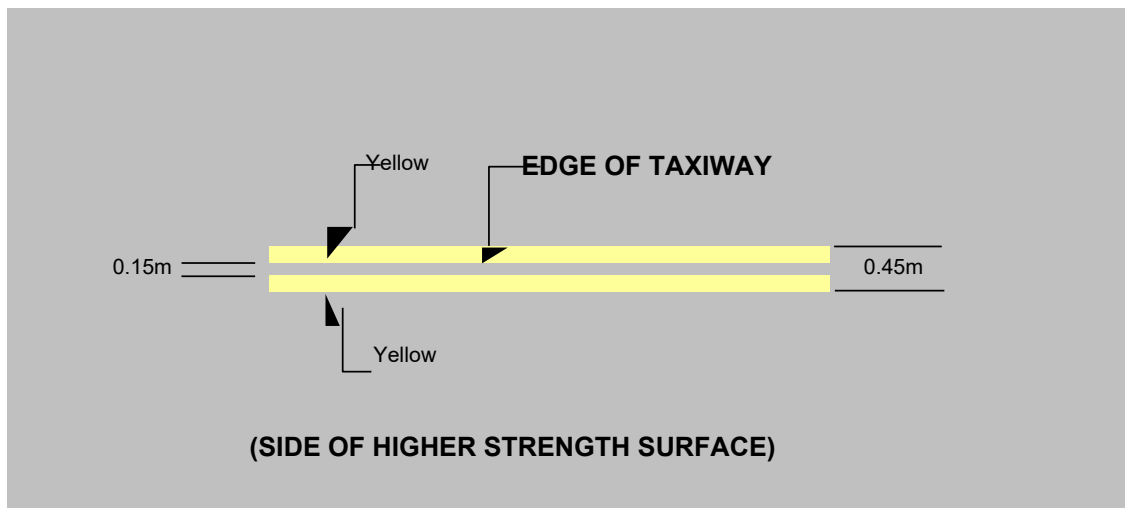
**Figure 8.42 (2) Intermediate holding position markings (illustrates matters)**

- (3) A taxiway guideline must be omitted between at least 0.9 m but not more than 1 m on each side of the intermediate holding position marking.

### 8.43 Taxiway edge markings

- (1) Taxiway edge markings must be provided for a paved taxiway of full pavement strength whose edges are not clearly visible.
- (2) Taxiway edge markings must consist of 2 continuous, parallel yellow lines, 0.15 m wide, and located at the taxiway edge, as shown in Figure 8.43 (2).
- (3) The outermost edge of a taxiway edge marking must correspond with the edge of the taxiway.

*Note* CASA recommends that transverse or herringbone yellow stripes be provided on any sealed sub-strength surface on a taxiway shoulder, or within the graded portion of the taxiway strip. The recommended dimensions of such stripes are 8 m long by 1 m wide.



**Figure 8.43 (2) Taxiway edge markings (illustrates matters)**

### 8.44 Holding bay markings

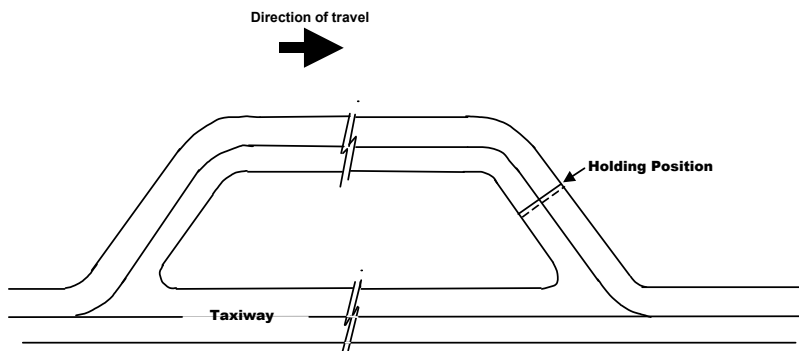
- (1) Holding bay markings must be provided on all sealed, asphalt or concrete holding bays.
- (2) As illustrated in Figure 8.44 (2), holding bay markings must consist of:
  - (a) taxi guidelines; and

Chapter 8 — Visual aids provided by aerodrome markings, markers, signals, signs, wind direction indicators etc.  
 Division 4 — Taxiway markings

(b) intermediate holding position markings.

*Note* Holding bay markings are to be located so that aircraft using the holding bay are separated from aircraft on the associated taxiway, as provided for in subsection 6.55 (2).

- (3) Subject to subsection (4), the holding position marking in the holding bay must be marked as if it were an intermediate holding position marking.
- (4) If the location of the holding position in a holding bay is also a runway holding position and thus requires a runway holding position to be provided, the Pattern A runway holding position marking must be used.



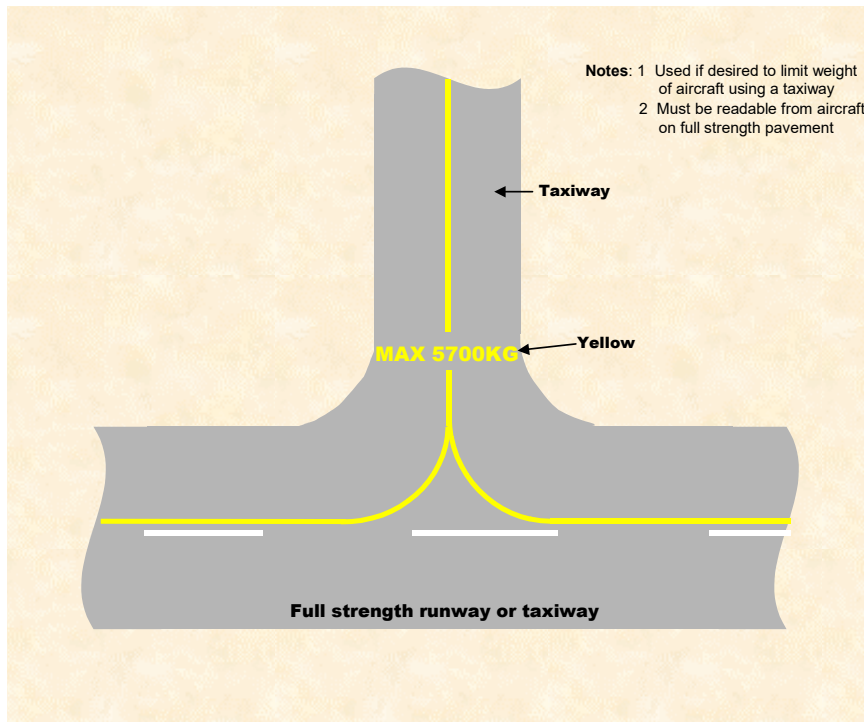
**Figure 8.44 (2) Holding bay markings (illustrates matters)**

#### **8.45 Taxiway limit markings**

- (1) Taxiway limit markings may be provided at the entrance of a taxiway to communicate, in annotated form, a limitation on aircraft operations on the taxiway.

*Note* Taxiway limits might include, but are not limited to, aircraft weight or aircraft wingspan.

- (2) As shown in Figure 8.45 (2), where a taxiway limit marking is provided, each letter and number used to communicate the limitation must:
  - (a) be coloured yellow; and
  - (b) be 2 m in height and in accordance with section 8.69; and
  - (c) have a 0.15 m line width; and
  - (d) except when part of an individual word, abbreviation, or numerical value — be separated from each other by 0.5 m spaces.
- (3) The marking must be positioned to be clearly readable by the pilot of an approaching aircraft before the aircraft enters the taxiway with the limitation.
- (4) The taxiway guideline must be omitted at least 0.9 m but not more than 1 m on each side of the taxiway limit marking.



**Figure 8.45 (2) Example of taxiway limit marking for aircraft weight due to pavement strength limitation (illustrates matters)**

## CHAPTER 8

### Division 5 Apron markings

#### 8.46 Introduction

- (1) If a sealed, asphalt or concrete apron is designed to accommodate any aircraft with:
  - (a) MTOW of more than 5 700 kg; and
  - (b) one or more nose wheels;then the following must be provided:
  - (c) taxi guidelines;
  - (d) primary aircraft parking position markings.

*Note* Where the same section of apron is to be used by multiple aircraft of differing size and weight, the aerodrome operator may also provide secondary aircraft parking position markings.

- (2) Apron markings must be designed:
  - (a) to be clearly discernible, succinct, uncluttered and, as far as possible, not overlapping; and
  - (b) to ensure that:
    - (i) all applicable clearance standards are met; and
    - (ii) safe manoeuvring and precise positioning of aircraft is achieved.

#### 8.47 Apron taxi guidelines

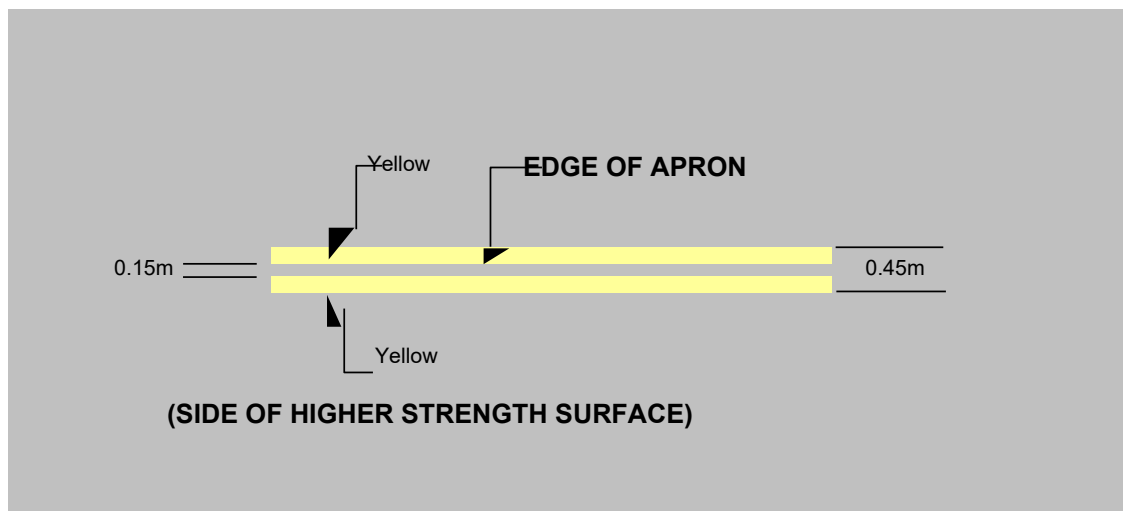
- (1) Apron taxi guidelines must be of the same form and proportions as taxi guideline markings.

*Note* The design of taxi guidelines on aprons is dependent on whether the aircraft is being directed by a marshaller or the pilot.
- (2) If aircraft are directed by a marshaller or a VDGS, the taxi guideline must be designed so that when the aircraft nose wheel follows the taxi guideline, all required clearances specified in section 6.58 are met.
- (3) If aircraft are guided by a pilot only, the taxi guideline must be designed so that if followed, all the required clearances are met:
  - (a) in the case of a multi-crew aircraft — from a point on the centreline of the aircraft midway between the pilot and the co-pilot seats; or
  - (b) in the case of a single pilot aircraft — from a point in the centre of the pilot seat.
- (4) If aircraft control moves from “pilot only” to a marshaller or a VDGS, the taxi guideline must ensure that all clearances are maintained for each instance.
- (5) At aircraft parking positions serviced by an aerobridge, the taxi guideline must be designed with reference to the nose wheel position.

#### 8.48 Apron edge markings

- (1) Apron edge markings must be provided if:
  - (a) the limit of high strength pavement cannot be distinguished from the surrounding area; and

- (b) aircraft parking is not restricted to fixed parking positions only.
- (2) As shown in Figure 8.48 (2), the apron edge must be identified by 2 continuous yellow lines:
  - (a) each of which is 0.15 m wide; and
  - (b) that are spaced 0.15 m apart.



**Figure 8.48 (2) Apron edge marking (illustrates matters)**

- (3) Apron edge markings must be interrupted at any point where an aircraft would otherwise have to cross the marking to access a taxiway.
- (4) For subsection (3), the width of the interruption must align with the width of the taxiway.
- (5) At the interface between the apron and a taxiway, apron edge markings must, as far as possible, transition directly into taxiway edge markings.

#### **8.49 Aircraft type designator markings**

- (1) An aircraft type designator marking may be used to designate which aircraft types may be accommodated in the area to which the marking applies.
- (2) Where an aircraft type designator marking is provided, the designation must use only the list of aircraft type designators published in ICAO Doc 8643, Aircraft Type Designators.

*Note 1* For ICAO documents, see section 1.07.

*Note 2* IATA designations, or common use terms such as “All aircraft”, are not permitted.

- (3) If:
  - (a) a stop line or parking position is to accommodate a number of aircraft types; and
  - (b) there is insufficient space to designate all of the aircraft types;
 then:
  - (c) the aircraft type designation marking must:
    - (i) list the largest or most critical aircraft types — provided all smaller or less critical aircraft may safely use the stop line, or the entire parking position (as applicable);
    - or



- (ii) list the range of aircraft types that may use the stop line or parking position — provided all aircraft types within the range may safely use the line or position; or
- (d) an alternate system of control must be documented in the aerodrome manual and implemented to prevent unsuitable aircraft types from using the stop line or parking position.

### 8.50 Parking clearance line

- (1) A parking clearance line delineates the area within which the whole of an aircraft is to be accommodated so that no part of the aircraft extends beyond the line.
- (2) Subject to subsection (3), parking clearance lines may be provided.
- (3) Parking clearance lines must be provided on aprons with unrestricted parking, if it is necessary to:
  - (a) limit aircraft parking to particular areas; or
  - (b) ensure clearance from other aircraft or obstacles.

*Note* Parking clearance lines may also be provided at an aircraft parking position in conjunction with parking position markings. This marking is useful to depict the area that must remain free of personnel, vehicles and equipment when an aircraft is taxiing (or being towed) into position or has started engines in preparation for departure. All of the area within the parking clearance line is considered to be an aircraft parking position.

- (4) A parking clearance line must be a continuous, contrasting red line that is:
  - (a) at least 0.10 m, but not more than 0.20 m, wide; and
  - (b) interrupted 0.9 m either side of a taxi guideline marking that would otherwise intersect with it.

*Note* CASA recommends that yellow should be used as a contrasting colour for the aircraft parking clearance line.

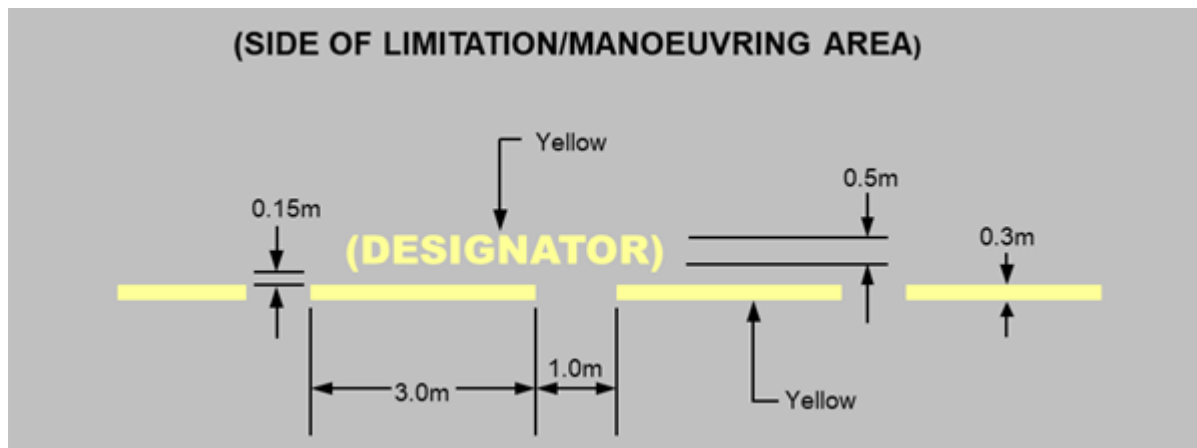
- (5) The words “PARKING CLEARANCE” must:
  - (a) be marked in yellow on any side of a parking clearance line where aircraft are parked; and
  - (b) be readable from that side; and
  - (c) be repeated at intervals not exceeding 50 m along the side; and
  - (d) use letters that are 0.3 m high, and located 0.15 m from the line, as shown in Figure 8.50 (5).



**Figure 8.50 (5) Parking clearance line (shows matters)**

### 8.51 Aircraft apron limit line markings

- (1) An apron limit line marking may be provided if the apron boundary:
  - (a) coincides with a taxiway strip; and
  - (b) needs to be marked to limit aircraft or vehicle movements.
- (2) As shown in Figure 8.51 (2), the apron limit line marking must consist of a single, broken yellow line, the dashes of which are 3 m long, 0.3 m wide, and 1 m apart.
- (3) If an apron limit line is required to limit aircraft movements, any designator describing the limitation must, as shown in Figure 8.51 (2), be marked 0.15 m above the line, in letters and numbers at least 0.5 m in height which are readable by the pilot in an approaching aircraft.
- (4) If:
  - (a) no taxi guidelines are provided; and
  - (b) aircraft are required to cross the apron limit line marking;
 then any designator describing the limitation must be:
  - (c) visible to an approaching aircraft before it enters the limited area; and
  - (d) repeated at intervals not exceeding 50 m.

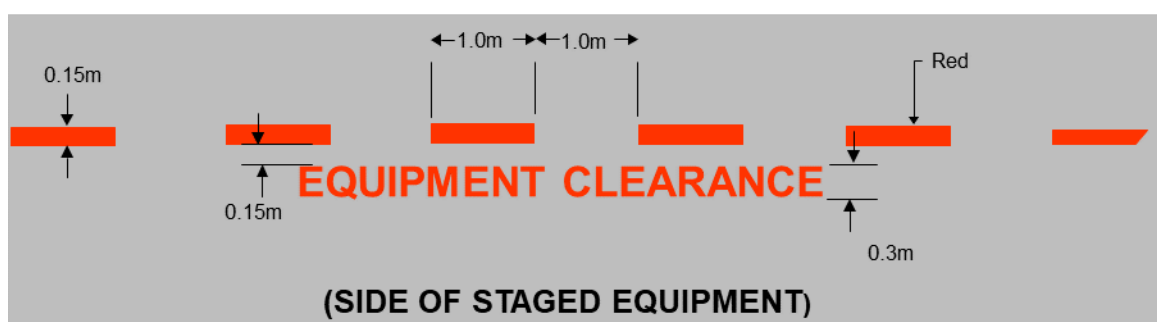


**Figure 8.51 (2) Apron limit line with optional designer (shows matters)**

### 8.52 Equipment clearance (staging) line markings

- (1) Equipment clearance (staging) line markings may be used on congested aprons to assist in ensuring that service vehicles and equipment keep clear of manoeuvring aircraft.
- (2) As illustrated in Figure 8.52 (2), the equipment clearance (staging) line marking must consist of a single, broken red line, the dashes of which are 1 m long, 0.15 m wide, and 1 m apart.
- (3) The designation “EQUIPMENT CLEARANCE” must be:
  - (a) marked in red along the outer boundary of the staging area occupied by the equipment; and
  - (b) readable from inside the staging area; and
  - (c) repeated along the line at intervals of not more than 30 m; and
  - (d) in letters 0.3 m high and 0.15 m from the red line.

*Note* Within an equipment staging area, white lines may be used to segregate the available area, for example, by equipment type or company.



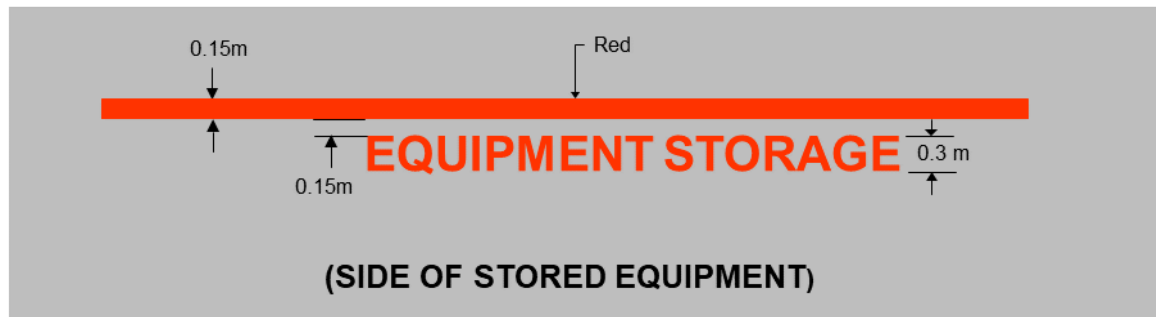
**Figure 8.52 (2) Equipment clearance (staging) line marking (illustrates matters)**

### 8.53 Equipment storage markings

- (1) Equipment storage markings may be provided.
- (2) Equipment storage markings must consist of a continuous red line that is 0.15 m wide.

- (3) The designation “EQUIPMENT STORAGE” must be marked in red on the side where equipment is stored, and be readable from that side.
- (4) The letters of the designation must be 0.3 m high and 0.15 m from the red line, as shown in Figure 8.53 (4).
- (5) The designation must be repeated at intervals along the line not exceeding 50 m.

*Note* Within an equipment storage area, white equipment clearance lines may be used to segregate the available area, for example, by equipment type or company.



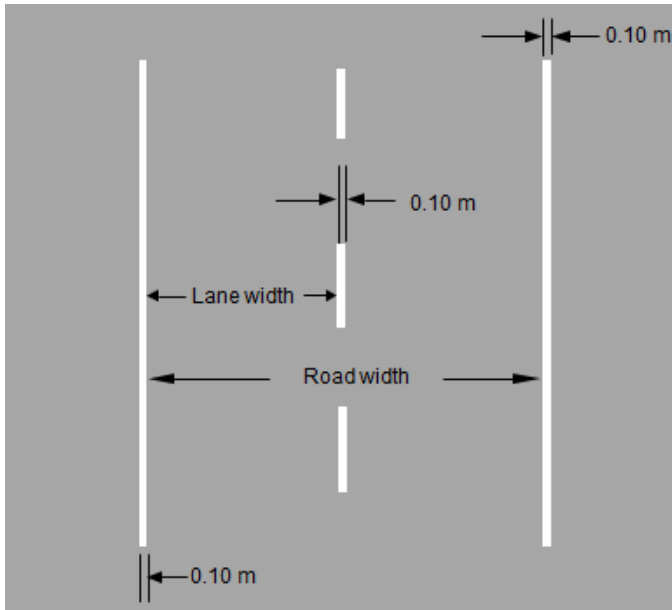
**Figure 8.53 (4) Equipment storage and apron road marking (illustrates matters)**

#### **8.54 Vehicle service road markings**

- (1) Service roads:
  - (a) may be provided on aprons; and
  - (b) if provided, must be marked with vehicle service road markings to keep vehicles clear of aircraft on taxiways and taxilanes.
- (2) An apron service road marking must consist of a continuous white line that is 0.1 m wide, as shown in Figure 8.54 (2).

*Note* Road markings can also be provided to facilitate efficient and safe movements outside the manoeuvring area.

- (3) Each lane of an apron service road must be of a minimum width to accommodate the widest vehicle that uses the road.

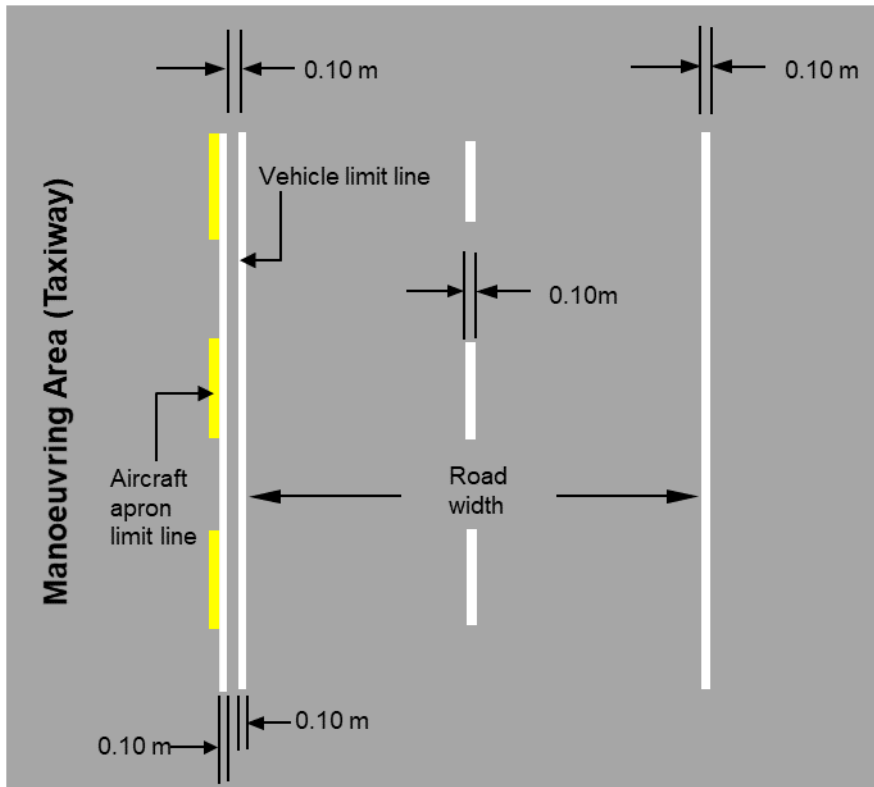


**Figure 8.54 (2) Apron service road (shows matters)**

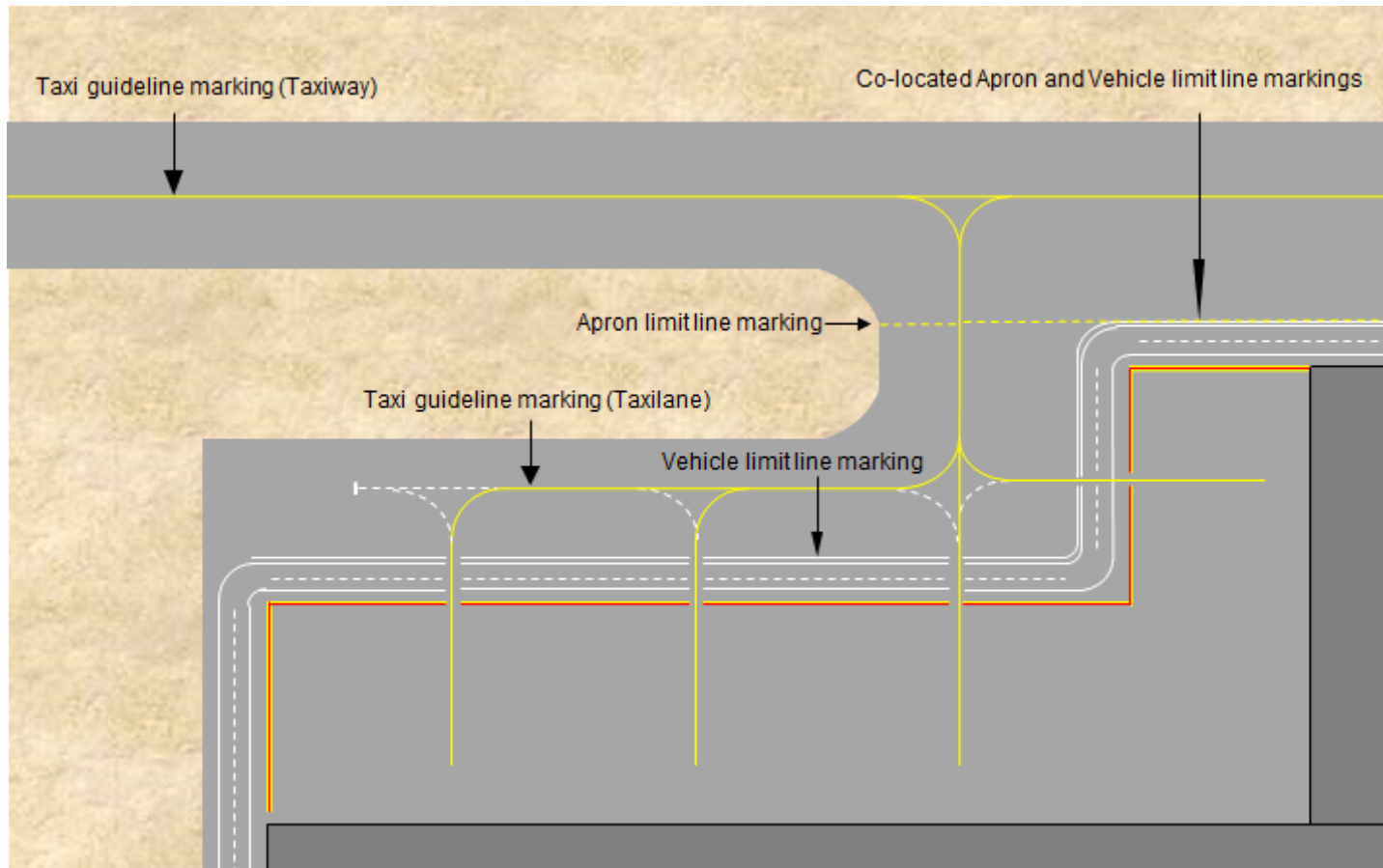
- (4) If an apron service road is located adjacent to where there are taxiing aircraft, the side of the apron service road bordering the taxiing aircraft must be shown with a vehicle limit line marking consisting of a continuous double white line, with each line being 0.1 m wide and separated from the other line by 0.1 m, as shown in Figure 8.54 (4)-1.

*Note 1* This continuous double white line is to be marked in conjunction with an apron limit line marking. The combination of a double white line and an apron limit line indicates to a vehicle DO NOT CROSS the line on to the adjoining taxiway without clearance or authorisation. A double white line without an apron limit line is for use where an apron service road is located beside a taxilane.

*Note 2* See also the example in Figure 8.54 (4)-2.



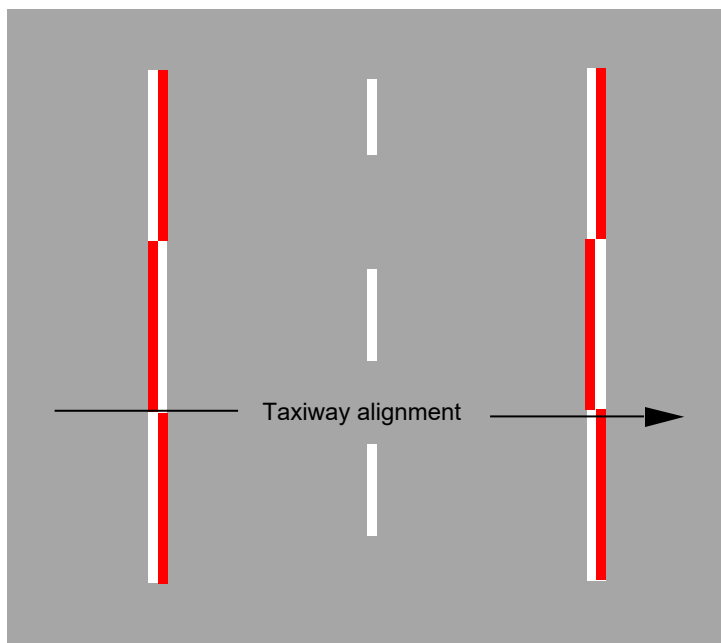
**Figure 8.54 (4)-1 Apron service road alongside a taxiway used in conjunction with the optional aircraft apron limit line marking (shows matters)**



**Figure 8.54 (4)-2 Example of an apron service road alongside an apron limit line, taxiways and taxilanes (illustrates matters)**

- (5) Where an apron service road crosses a taxiway or an apron taxilane, the service road marking must be presented in a white zipper pattern as shown in Figure 8.54 (5) with each segment of the zipper not more than 50 cm in length.

*Note* This type of edge marking makes the road more conspicuous to the pilots of aircraft operating on the taxiway or taxilane. To this end, CASA recommends that a contrasting colour such as red be added to offset the white of the vehicle service road marking.



**Figure 8.54 (5) Example of an apron service road crossing with red colour contrasted markings (illustrates matters)**

## 8.55 Aircraft parking position markings

- (1) In this section:

***primary aircraft parking positions*** means aircraft parking positions designed for normal apron circumstances and demand.

***secondary aircraft parking positions*** means aircraft parking positions designed to provide alternative parking positions for use:

- (a) during abnormal circumstances or demand; or
  - (b) to allow smaller or larger aircraft than the primary aircraft parking position was designed for in normal circumstances and demand, to be parked.
- (2) This section applies if an aerodrome operator provides:
- (a) primary aircraft parking positions, on sealed, concrete or asphalt apron surfaces, for the use of aircraft with:
    - (i) MTOW of 5 700 kg or more; and
    - (ii) one or more nose wheels; or
  - (b) both primary aircraft parking positions, as described in paragraph (a), and secondary aircraft parking positions.



- (3) Aircraft parking position markings must be provided in the form of the following:
  - (a) lead-in lines;
  - (b) primary parking position markings;
  - (c) lead-out lines;
  - (d) designation markings.
- (4) Secondary parking position markings may be provided in addition to primary parking position markings, but must not be provided in lieu of the primary parking position markings.

### **8.56 Lead-in lines**

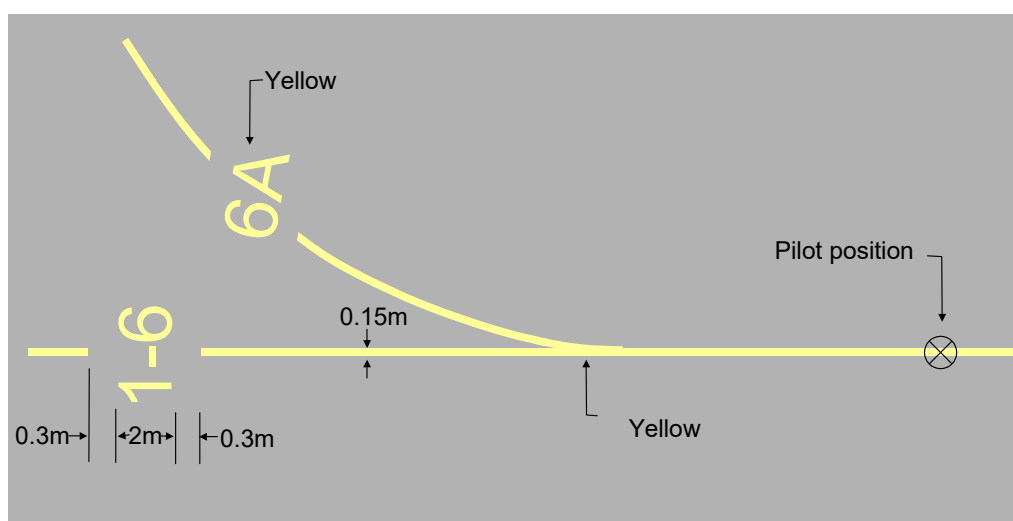
- (1) A lead-in line must be provided to each aircraft parking position on a sealed, concrete or asphalt apron with aircraft parking position markings.

*Note* A lead-in line is a continuation of the taxi guideline until it reaches the alignment line on the parking position.
- (2) A lead-in line to a primary aircraft parking position must be a continuous line, 0.15 m wide and coloured yellow.
- (3) For subsection (2), if a lead-in line is aligned with other markings, for example, a lead-out line or a push-back marking, the lead-in line is the primary marking.
- (4) A lead-in line to a secondary aircraft parking position must be:
  - (a) a continuous line, 0.15 m wide and coloured yellow; or
  - (b) the following:
    - (i) a series of solid yellow circles, 0.15 m in diameter and spaced at 1 m intervals;
    - (ii) for an abrupt turn in the lead-in line — a continuous, yellow line that is 0.15 m wide for a distance of 2 m before and after the turn.

### **8.57 Aircraft parking position designation markings — apron taxiway and taxilane**

- (1) An aircraft parking position designation marking must use a number and may use a letter number combination (other than “H”) to indicate the parking position to which a taxi guideline leads.
- (2) Aircraft parking position designation markings must be provided where an apron has more than 1 marked aircraft parking position.
- (3) As shown in Figure 8.57 (3), a taxi guideline leading to more than 1 aircraft parking position must be located at the beginning of each diverging taxi guideline or lead-in line location and continue until the parking positions are reached.
- (4) Primary aircraft parking positions must be designated sequentially with no omissions as far as practicable.
- (5) As shown in Figure 8.57 (3), secondary aircraft parking positions must be identified with:
  - (a) the same number as the associated primary aircraft parking position; and
  - (b) an alphabetical suffix.

- (6) For subsection (5), suffixes must start with the letter “A” (for the first secondary aircraft parking position associated with a primary aircraft parking position) and be lettered sequentially thereafter with no omissions.
- (7) For subsection (5), each designation marking must be:
  - (a) located at the beginning of each diverging taxi guideline or lead-in line; and
  - (b) aligned so that it can be seen by the pilot of an approaching aircraft.
- (8) As shown in Figure 8.57 (3), the numbers and letters in aircraft parking designation markings must be as follows:
  - (a) 2 m high and coloured yellow;
  - (b) aligned with the taxi guideline or lead-in line to be easily read by a pilot approaching on the line, but in a line break space;
  - (c) the line break space must extend for 0.3 m on either side of the designation marking.



**Figure 8.57 (3) Aircraft parking position designation numbers and letters (shows matters)**

### 8.58 Aircraft parking position designations — parking position

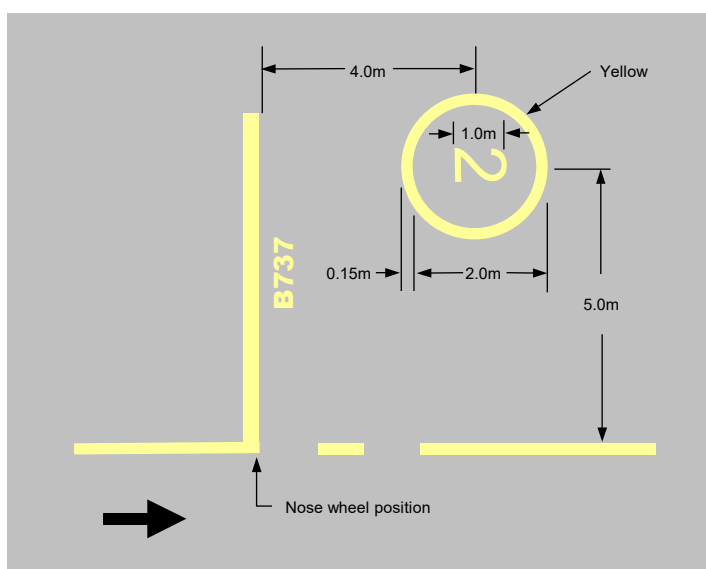
- (1) The aircraft parking position designation must be located:
  - (a) on the ground adjacent to the parking position; and
  - (b) such that it is clearly visible to the pilot of an approaching aircraft.
- (2) As shown in Figure 8.58 (2)-1, for fixed-wing aircraft, the aircraft parking position designation must be as follows:
  - (a) marked on the ground;
  - (b) coloured yellow;
  - (c) comprising numbers 1 m high, located in a circle with a 2 m inside diameter and 0.15 m line thickness;
  - (d) with the centre of the circle, as viewed by the pilot:
    - (i) 4 m forward of the nose wheel position; and
    - (ii) 5 m to the left.

- (3) The size of the aircraft parking position designation must not be less than the legend and face size specified in section 8.69 and Figures 8.69 (1)-1 to 8.69 (1)-5.

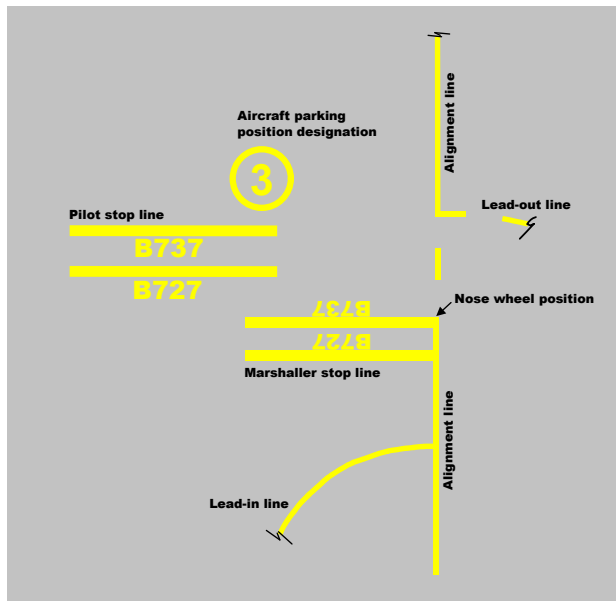
*Note* An illustration showing a combination of all the aircraft parking position markings at an aircraft parking position is shown in Figure 8.58 (2)-2.

- (4) The aircraft parking position designation may be omitted from the ground at a parking position serviced by a VDGS or an A-VDGS if:
- (a) the aircraft parking position designation is marked on the parking position identification sign in white letters on a black background, or black letters on a yellow background; and
  - (b) the parking position designation is:
    - (i) provided by means of a VDGS or an A-VDGS; and
    - (ii) clearly visible to the pilot of the approaching aircraft.

*Note* See section 9.126 for details of parking position identification signage.



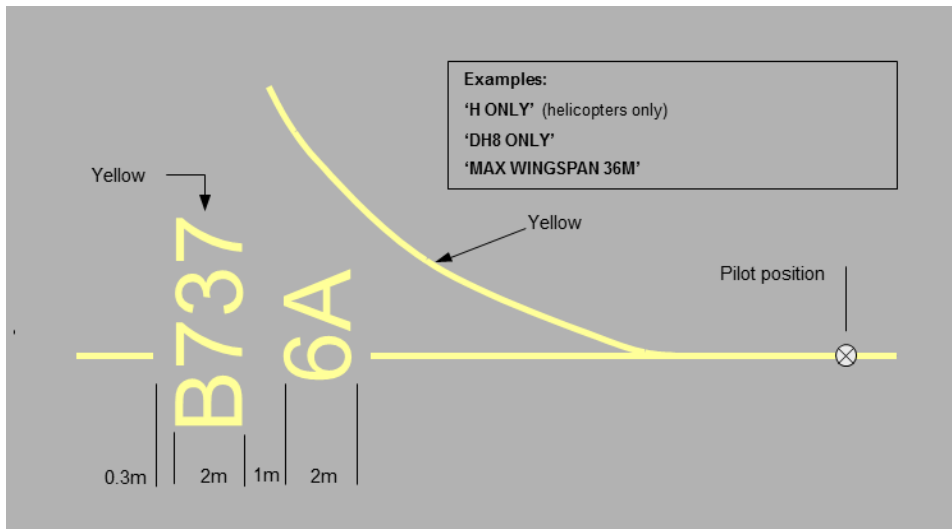
**Figure 8.58 (2)-1 Aircraft parking position designation (shows matters)**



**Figure 8.58 (2)-2 Aircraft parking position markings (illustrates matters)**

### **8.59 Aircraft type parking restriction designator markings**

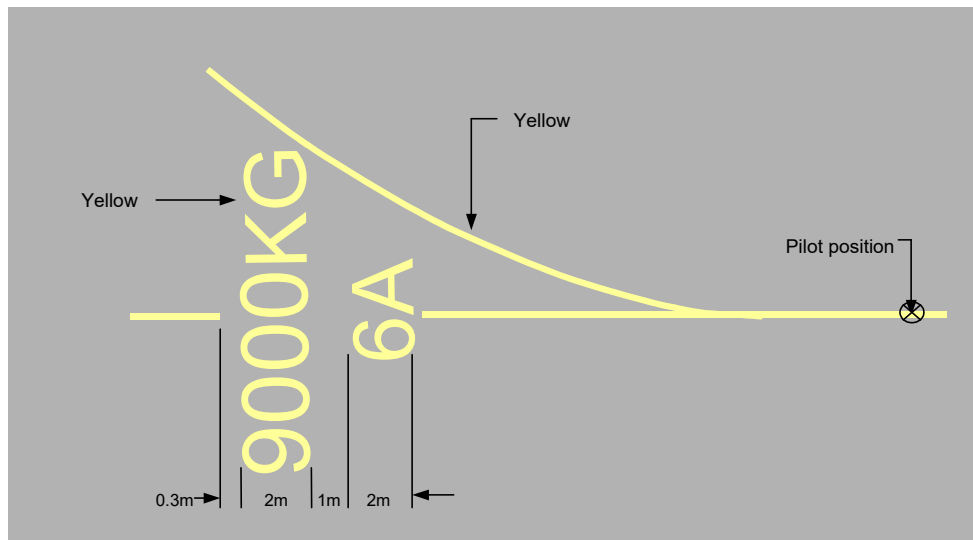
- (1) An aerodrome operator may provide an aircraft type parking restriction designation to indicate the type of aircraft that a parking position accommodates.
- (2) As shown in Figure 8.59 (2), an aircraft type parking restriction designation must be as follows:
  - (a) 2 m high, coloured yellow, and located in the space made by a break in the lead-in line (the *space*);
  - (b) aligned with the lead-in line to be easily read by a pilot approaching on the line;
  - (c) from the perspective of an approaching pilot:
    - (i) 1 m beyond the relevant aircraft parking position designator that is in the space; and
    - (ii) 0.3 m from where the lead-in line recommences after the space.
- (3) Aircraft type parking restriction designations must comply with the standards for aircraft type designator markings mentioned in section 8.49.
- (4) Aircraft type parking restriction designations must be provided at the lead-in line for each position to which an aircraft type parking restriction applies.
- (5) Where a diverging lead-in line leads to an apron parking position suitable for helicopters only, the designation “H ONLY” must be provided.



**Figure 8.59 (2) Aircraft type designator markings (shows matters)**

### 8.60 Aircraft parking position limit designators

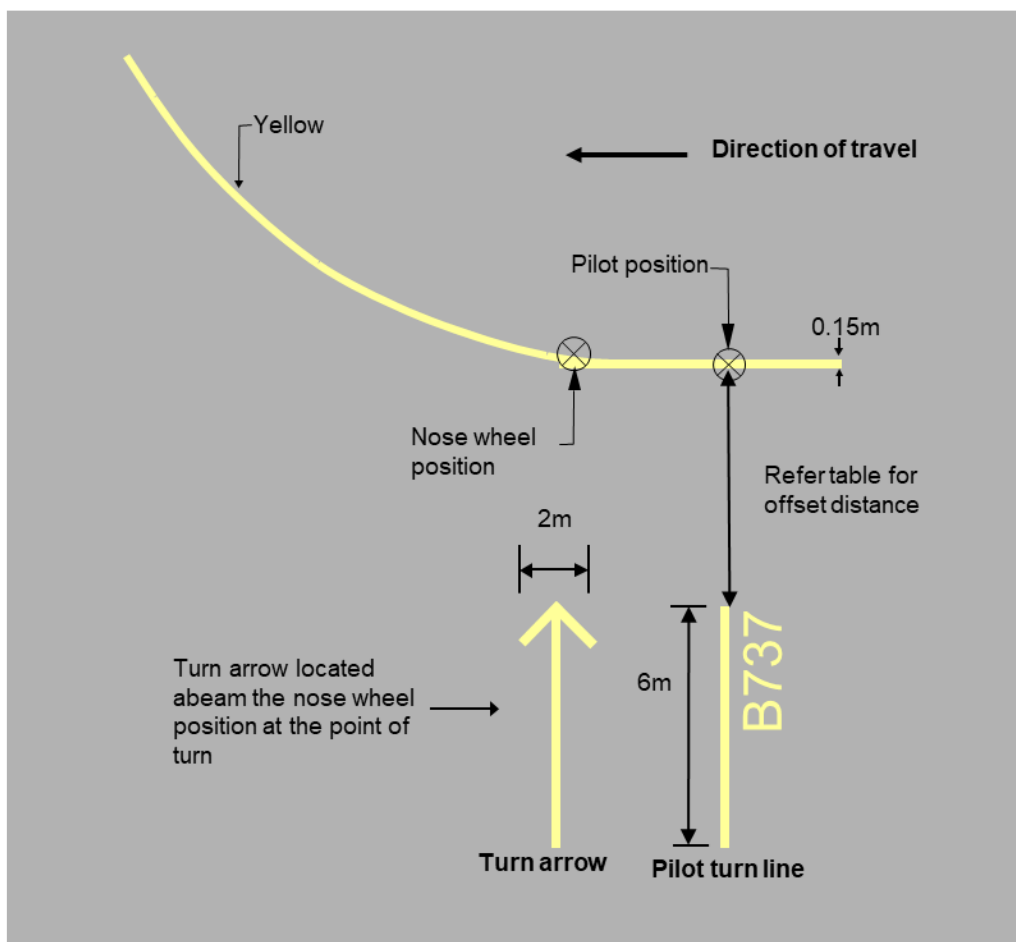
- (1) An aerodrome operator may provide an aircraft parking position limit designator to inform pilots of any limitation applying to a parking position, for example, arising from an aircraft's weight or wingspan.
- (2) As illustrated in Figure 8.60 (2) for a weight limit, an aircraft parking position limit designator must be as follows:
  - (a) 2 m high, coloured yellow, and located in the space made by a break in the lead-in line (the *space*);
  - (b) aligned with the lead-in line to be easily read by a pilot approaching on the line;
  - (c) from the perspective of an approaching pilot:
    - (i) 1 m beyond the relevant aircraft parking position designation that is in the space; and
    - (ii) 0.3 m from where the lead-in line recommences after the space;
  - (d) if used to limit aircraft weight — expressed in kilograms;
  - (e) if used to limit wingspan — expressed in metres.



**Figure 8.60 (2) Parking position limit designator (example for aircraft weight) (shows matters)**

### 8.61 Pilot turn line markings

- (1) An aerodrome operator may provide a pilot turn line at the point of initiation of any turn.
- (2) A pilot turn line must be as follows:
  - (a) placed at right angles to the relevant lead-in line;
  - (b) located on the left-hand side as viewed by the pilot;
  - (c) marked with a 6 m long and 0.3 m wide yellow line located abeam the pilot's position when the aircraft nose wheel is at the point of initiation of the turn;
  - (d) supplemented by a 6 m long and 0.3 m wide parallel yellow line that is:
    - (i) located abeam the position of the aircraft nose wheel when the wheel is at the point of initiation of the turn; and
    - (ii) marked with a yellow, 45 degree, 2 m wide arrowhead, indicating the direction of turn.



**Figure 8.61 (2) Pilot turn line markings (shows matters)**

- (3) If an aircraft type designation is provided with the pilot turn line, it must be marked in yellow letters, 1 m high and 0.15 m below the turn line, facing the direction of incoming aircraft.
- (4) For subsection (3), for an aerodrome reference code letter mentioned in a row of column 1 of Table 8.61 (4) — the aircraft type designation must be offset from the lead-in line by the distance specified in the same row in column 2.

**Table 8.61 (4) Pilot turn line and aircraft type designation offset**

Aerodrome reference code letter	Offset
A, B or C	5 m
D, E or F	10 m

### 8.62 Primary aircraft parking position markings

- (1) Primary aircraft parking position markings must be comprised of the following:
  - (a) a lead-in line to the aircraft stop position;
  - (b) a stop line or stop lines for the aircraft (the *relevant aircraft*) for which the primary aircraft parking position is provided;
  - (c) aircraft type designation markings for the relevant aircraft;

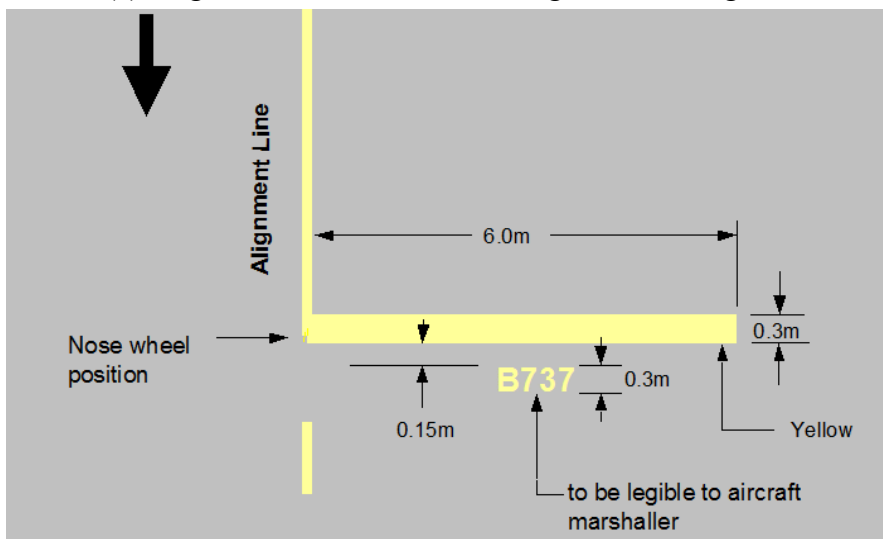
(d) a relevant aircraft parking position designation.

*Note* The position of the stop line depends on whether the aircraft is under the control of the apron marshaller, a VDGS, or the pilot. A VDGS is sometimes called a “Nose in Guidance System” or NIGS. Where a VDGS is not provided for a primary aircraft parking position, an alignment line must be provided beyond the stop line — see section 8.65.

(2) Where an aircraft is required to power out of the parking position, a lead-out line must be provided.

### 8.63 Marshaller stop lines

- (1) A marshaller stop line must be provided for any aircraft parking position where a marshaller is required to accurately determine the stopping position of the aircraft.
- (2) As shown in Figure 8.63 (2), a marshaller stop line must:
  - (a) be a yellow line that is 6 m long and 0.3 m wide; and
  - (b) commence where the aircraft nose wheel is to stop; and
  - (c) as seen by the marshaller facing the incoming aircraft — run at right angles to, and on the right-hand side of, the lead-in line.
- (3) Despite paragraph (2) (c), the marshaller stop line may be placed on the left-hand side of, or equally across, the lead-in line if it is not physically possible to mark the line on the right-hand side.
- (4) The aircraft type designation for a marshaller stop line must be in yellow numbers and letters that are:
  - (a) 0.3 m high; and
  - (b) 0.15 m below the midpoint of the marshaller stop line; and
  - (c) legible to the marshaller facing the incoming aircraft.



**Figure 8.63 (2) Marshaller stop line (shows matters)**

### 8.64 Pilot stop line markings

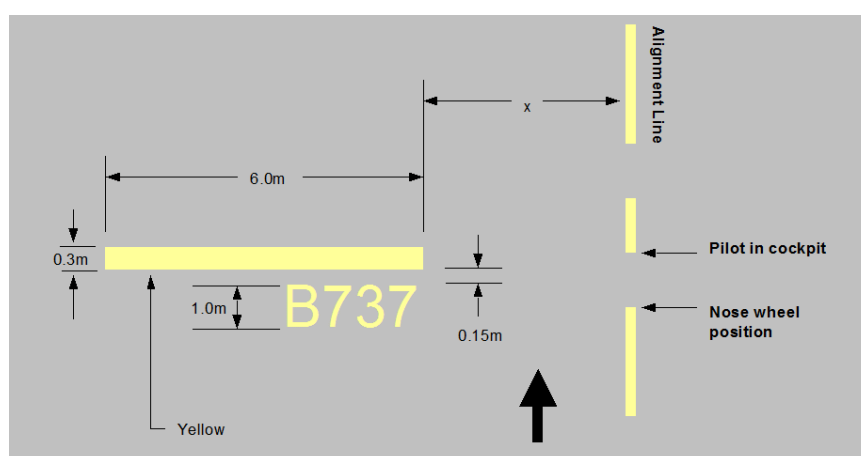
- (1) A pilot stop line must be provided if there is no marshaller, VDGS, or A-VDGS available.
- (2) A pilot stop bar may be provided if a marshaller, VDGS or A-VDGS is available.



- (3) As shown in Figure 8.64 (3), the pilot stop line must be such that when the aircraft is stopped at the nose wheel position, the line is:
- (a) to the left of the pilot; and
  - (b) 6 m long, 0.3 m wide and coloured yellow; and
  - (c) offset from the alignment line by the distance mentioned in a row of column 2 of Table 8.64 (3) that corresponds to the aerodrome reference code letter mentioned in the same row in column 1 that is the reference code letter for the aircraft.

**Table 8.64 (3) Pilot stop line offset**

Aerodrome reference code letter	Offset from the alignment line
A, B or C	5 m
D, E or F	10 m



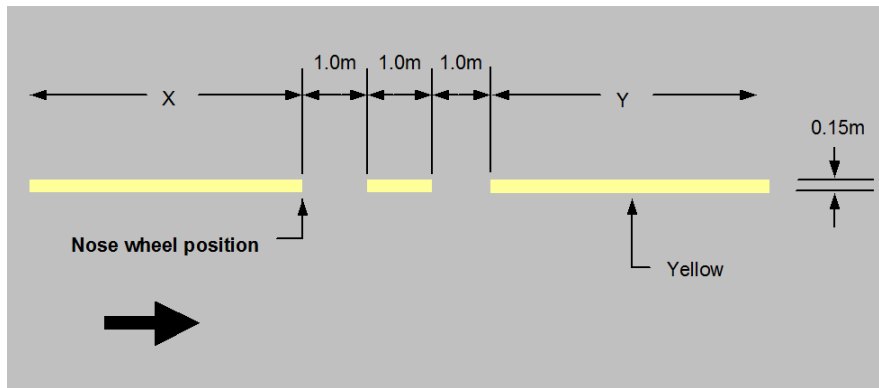
**Figure 8.64 (3) Pilot stop line (no marshaller) (shows matters)**

- (4) Despite paragraphs (3) (b) and (c), if aircraft of all reference code letters are to be accommodated at the 1 parking position then:
- (a) the offset value for code letter C must be used; and
  - (b) the length of the pilot stop line marking must be 11 m.
- (5) As shown in Figure 8.64 (3), the aircraft type designation for the pilot stop line must be written in yellow numbers and letters that are:
- (a) 1 m high; and
  - (b) 0.15 m below the pilot stop line; and
  - (c) aligned to end where the pilot stop line ends on the side closest to the pilot; and
  - (d) legible to the pilot of an approaching aircraft.

## 8.65 Alignment lines

- (1) If no VDGS is provided, an aerodrome operator must provide an alignment line beyond the stop line.
- (2) As shown in Figure 8.65 (2), the alignment line must:
  - (a) be coloured yellow; and

- (b) have a line width of 0.15 m; and
- (c) extend from the location of an aircraft nose wheel in the parked position, backwards under the body of the aircraft for a distance “X”; and
- (d) extend forward from the location of the aircraft nose wheel in the parked position, commencing at a point 3 m past the most forward nose wheel position, for a distance “Y”; and
- (e) be such that there is a 1 m long section of the alignment line placed in the centre of the 3 m gap.



**Figure 8.65 (2) Alignment line (shows matters)**

- (3) For subsection (2), for an aircraft with a reference code letter mentioned in a row of column 1 in Table 8.65 (3):
  - (a) X = the distance mentioned in the same row in column 2; and
  - (b) Y = the distance mentioned in the same row in column 3.

**Table 8.65 (3) Alignment line distances for X and Y**

Aerodrome reference code letter	Distance X	Distance Y
A or B	5 m	9 m
C, D, E or F	10 m	18 m

- (4) Despite paragraph (2) (d), the alignment line may be truncated if the provision of the full length is not possible due to a physical obstruction, provided that the truncation does not create a hazard to aircraft operations.
- (5) Subsection (1) does not apply if:
  - (a) the aerodrome manual records that a marshaller must be present for an arriving aircraft that is to use the parking position; and
  - (b) a marshaller is present accordingly.

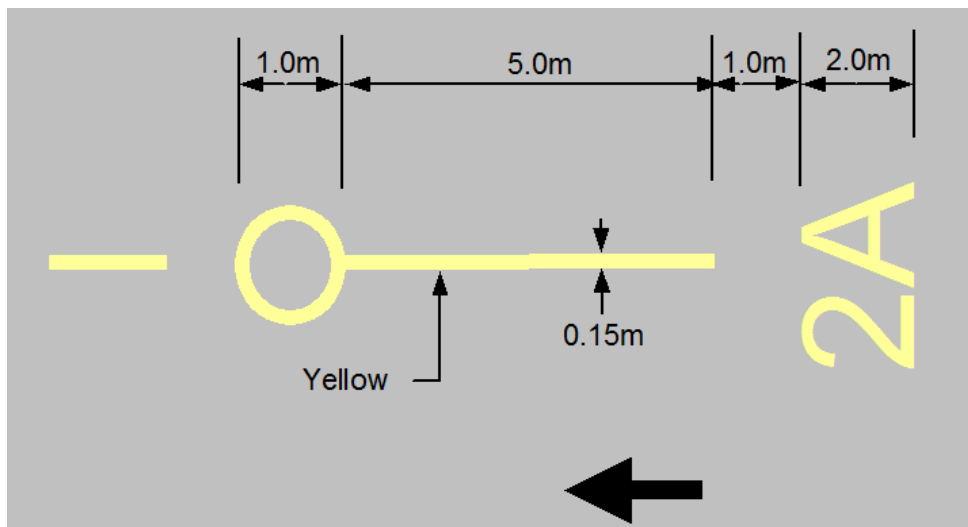
## 8.66 Secondary aircraft parking position markings

- (1) If provided under subsection 8.55 (4), secondary aircraft parking position markings must comprise:
  - (a) a lead-in line or dots to the aircraft stop position; and
  - (b) a stop line for each aircraft (the *relevant aircraft*) for which the secondary aircraft parking position is provided; and

- (c) aircraft type designation markings for the relevant aircraft; and
  - (d) an aircraft parking position designation.
- (2) Secondary aircraft parking position markings must be coloured yellow.
  - (3) Where a secondary aircraft parking position marking and a primary aircraft parking position marking would otherwise overlap:
    - (a) the primary aircraft parking position marking must be marked in preference to the secondary aircraft parking position marking; and
    - (b) the secondary aircraft parking position marking must be omitted by 0.9 m either side of the primary aircraft parking position marking.

### 8.67 Keyhole markings

- (1) Despite paragraph 8.66 (1) (b), if the secondary parking position is designed for aircraft with a wingspan of up to 24 m, the stop position may be identified with a keyhole marking as shown in Figure 8.67 (1).
- (2) The marking must be located so that the centre of the ring is at the final nose wheel position.
- (3) If required, any aircraft type or weight limit designation must be located at the commencement of the associated lead-in line or dotted line.
- (4) If neither a VDGS nor a marshaller is provided for the parking position, the keyhole marking must also be marked with both a pilot stop line and an alignment line.

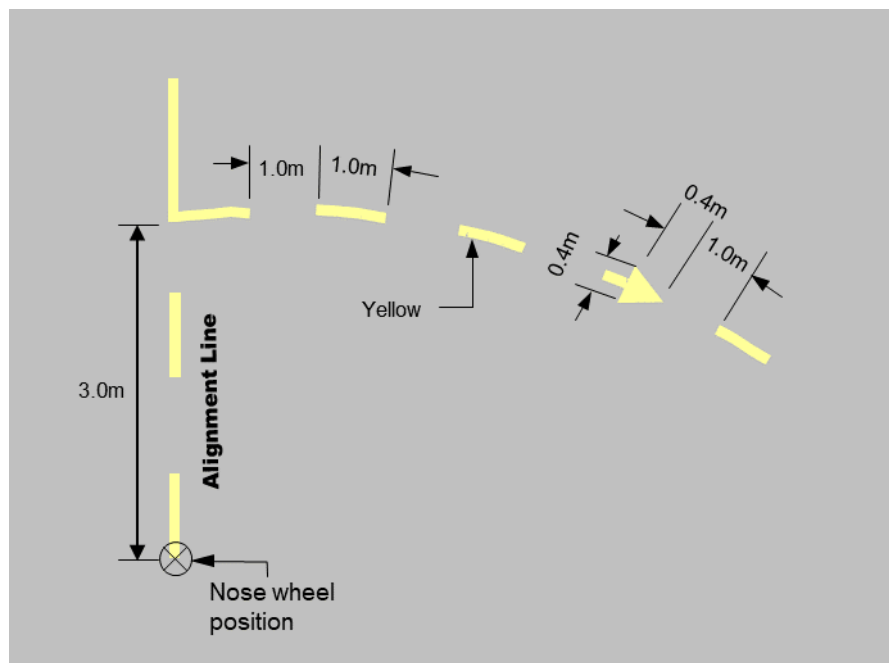


**Figure 8.67 (1) Keyhole marking (shows matters)**

### 8.68 Lead-out lines

- (1) A lead-out line must be provided on a parking position where an aircraft is to depart from a parking position under its own power and without the assistance of a push-back vehicle or unit.
- (2) A lead-out line must take the form of a line of dashes, with each dash being 1 m long, 0.15 m wide, coloured yellow, and with 1 m intervals between each dash.
- (3) The lead-out line must commence from the alignment line at least 3 m from the nose wheel position, as shown in Figure 8.68 (3).

- (4) The lead-out line must extend to a point from where the pilot can clearly see the taxi guideline.
- (5) As shown in Figure 8.68 (3), if direction arrow indicators are inserted, the first arrow must be at least 15 m along the lead-out line from the alignment line, with subsequent arrows at 30 m spacing.

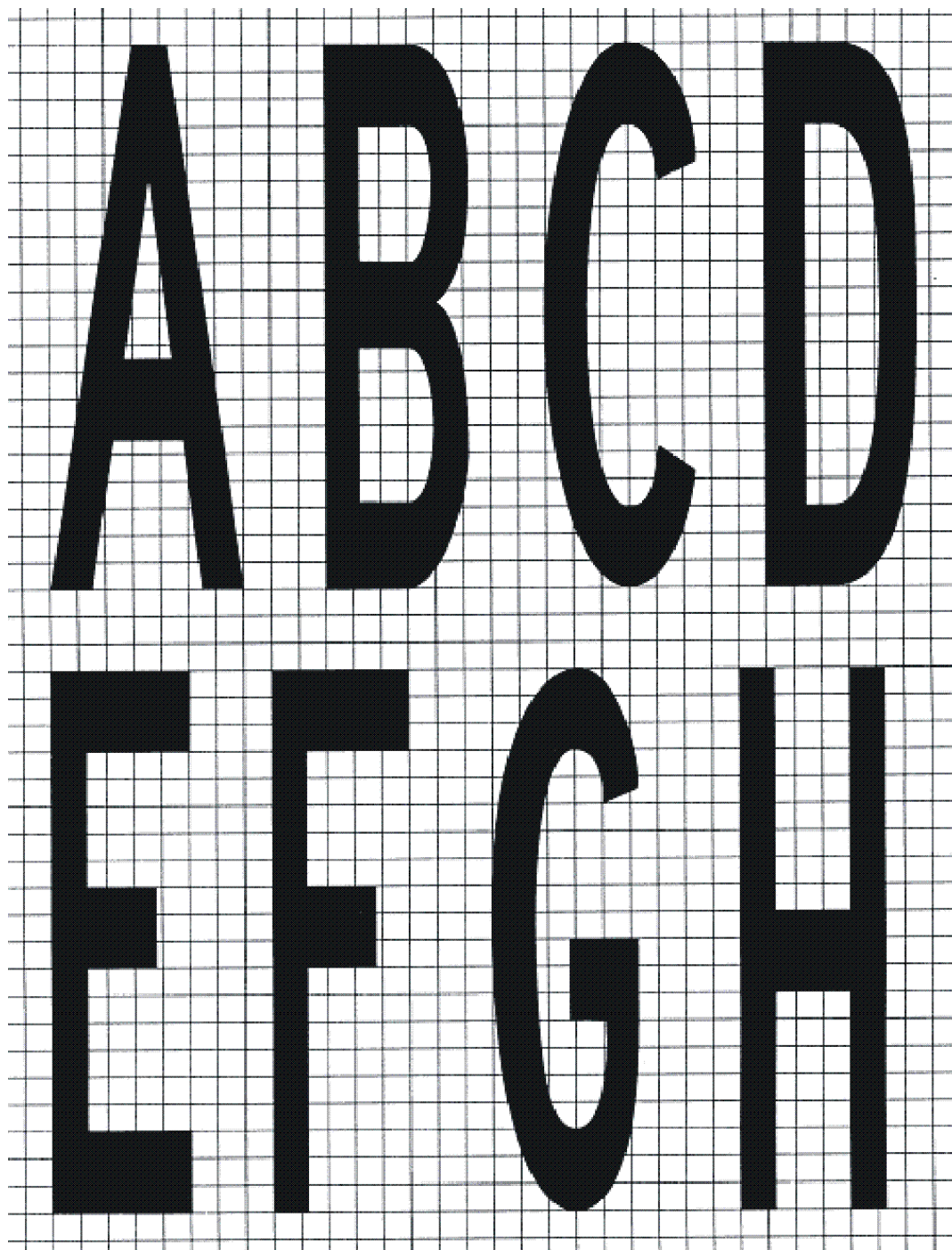


**Figure 8.68 (3) Lead-out line (shows matters)**

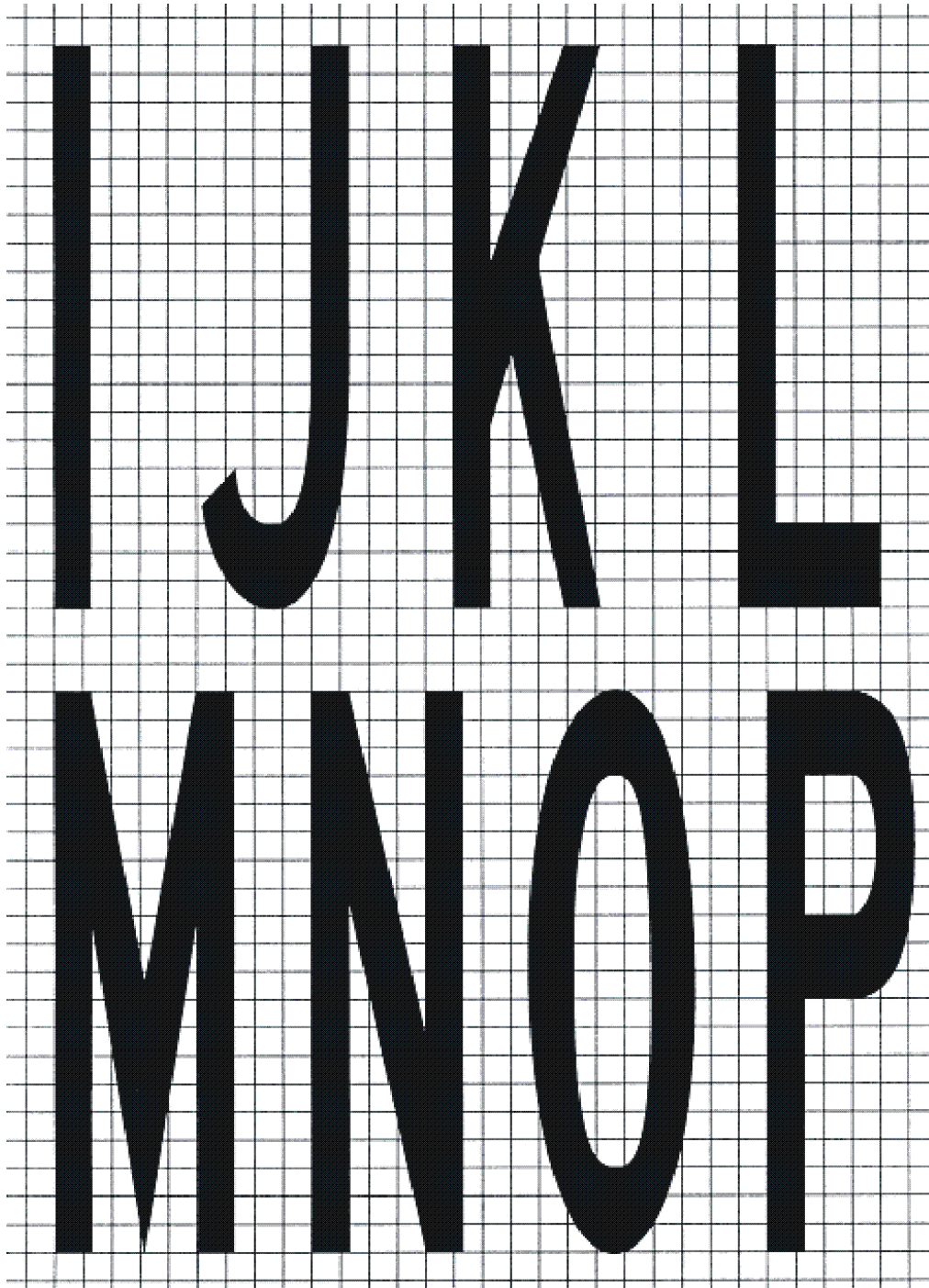
### 8.69 Designation characters for taxi and apron markings

- (1) Subject to this section, all letters and numbers used in designations for taxi and apron markings must conform in style and proportion as shown in Figures 8.69 (1)-1 to 8.69 (1)-5.
- (2) Actual dimensions must be determined in proportion to the overall height standard for each specific designator using the values attributed to the size of the cells of the grid in the relevant figure.
- (3) For designators that are 0.3 m in height, the cell size to be used in the figures and letters is 0.015 m<sup>2</sup>.
- (4) For designators that are 0.5 m in height, the cell size to be used in the figures and letters is 0.025 m<sup>2</sup>.
- (5) For designators that are 1 m in height, the cell size to be used in the figures and letters is 0.05 m<sup>2</sup>.
- (6) For designators that are 2 m in height, the cell size to be used in the figures and letters is 0.10 m<sup>2</sup>.
- (7) Unless otherwise stated in the associated standard, the spacing between letters must be at least 1 cell space based on the cell size used for the letters.
- (8) Unless otherwise stated in the associated standard, the spacing between letters, and numbers or other symbols (*characters*), must be at least 3 cell spaces.

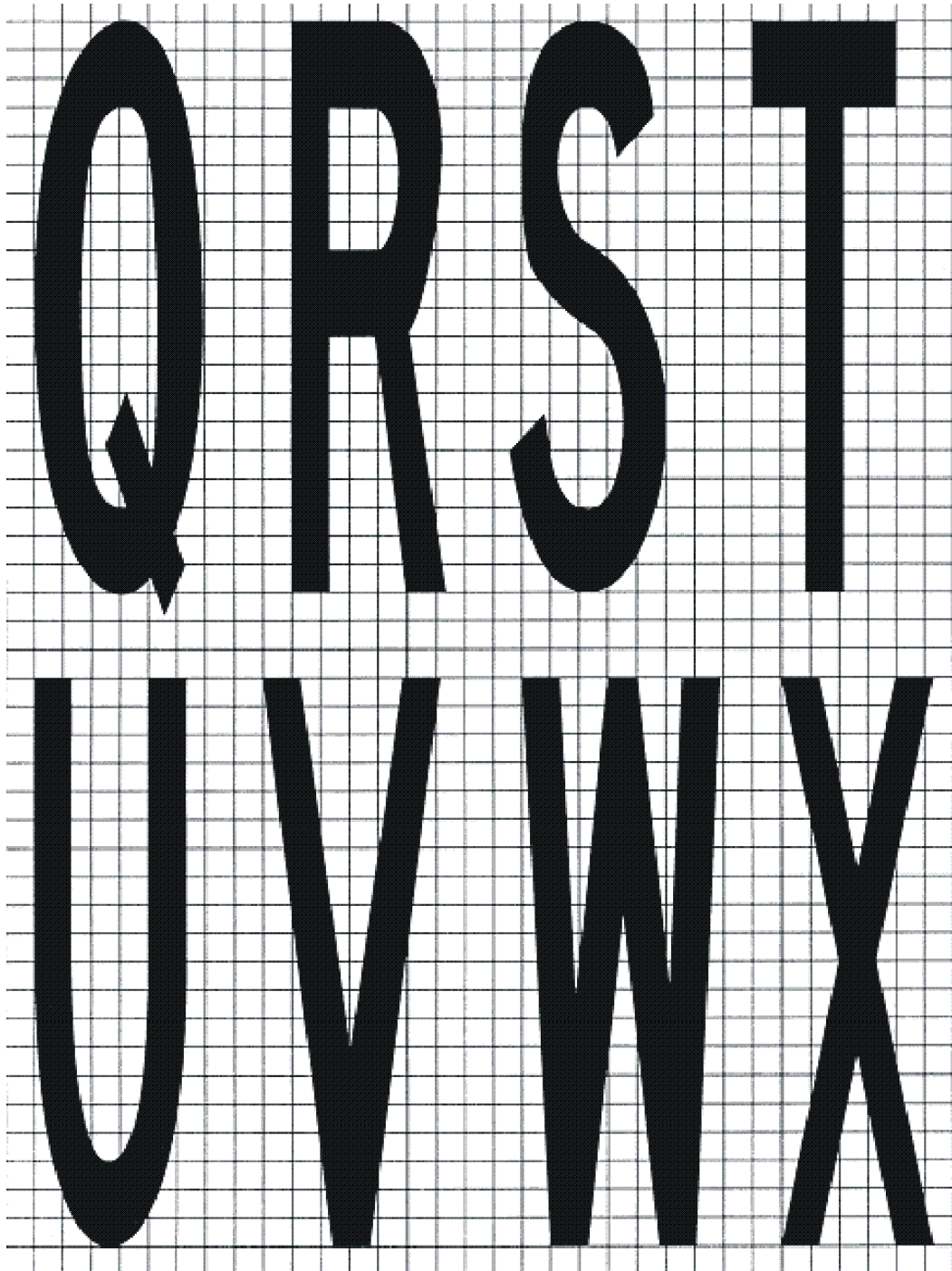
- (9) Unless otherwise stated in the associated standard, the spacing between words or data groups must be at least 6 cell spaces.



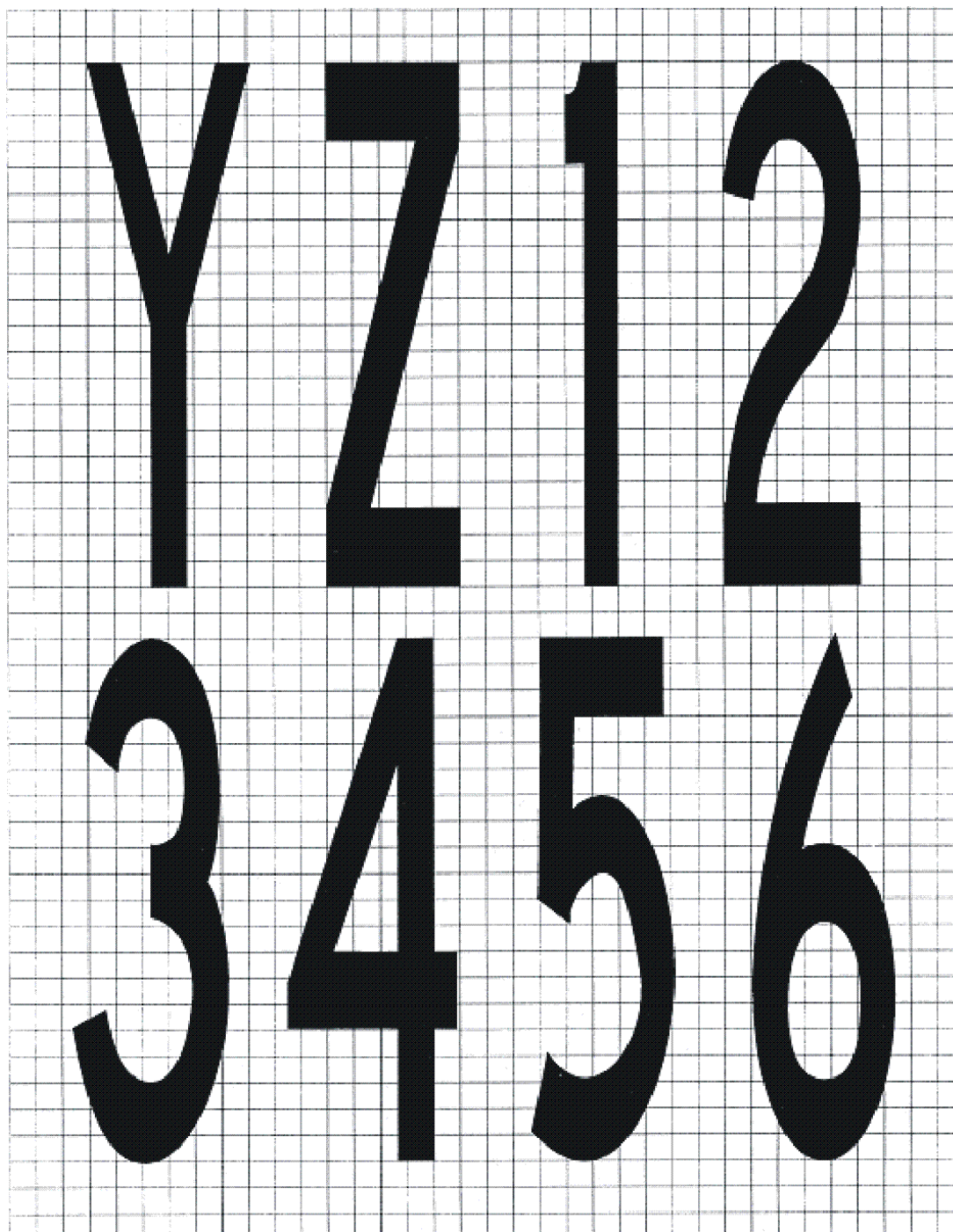
**Figure 8.69 (1)-1 Letters and numbers used in designations for taxiway and apron markings (shows matters)**



**Figure 8.69 (1)-2 Letters and numbers used in designations for taxiway and apron markings (shows matters)**

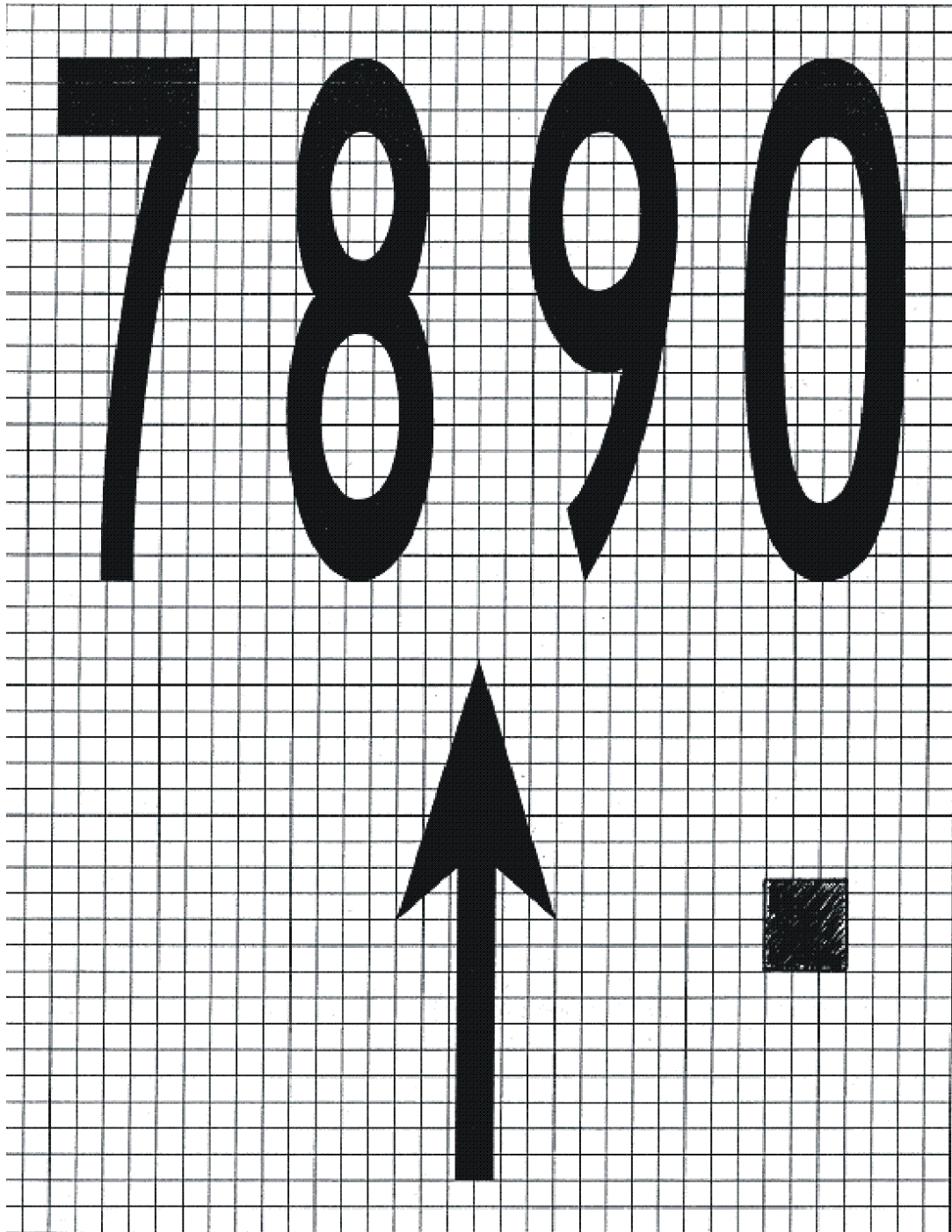


**Figure 8.69 (1)-3 Letters and numbers used in designations for taxiway and apron markings (shows matters)**



**Figure 8.69 (1)-4 Letters and numbers used in designations for taxiway and apron markings (shows matters)**





**Figure 8.69 (1)-5 Letters and numbers used in designations for taxiway and apron markings (shows matters)**

### **8.70 Push-back operator guidance markings**

- (1) Push-back vehicle operator guidance markings may be provided on aprons where aircraft are being pushed back by push-back vehicles (which includes push-back units).
- (2) Push-back vehicle operator guidance markings must include, as a minimum:
  - (a) aircraft push-back lines; and
  - (b) towbar disconnect points.

- (3) Push-back vehicle operator guidance markings must be based on the nose wheel of the aircraft for which the markings are provided regardless of the contact point with the push-back vehicle.

*Note* Where multiple aircraft types use push-back vehicle operator guidance markings, CASA recommends that the aerodrome operator provide 1 set of guidance markings designed around the most critical aircraft type in terms of size, turn radius and the typical under- or over-steer.

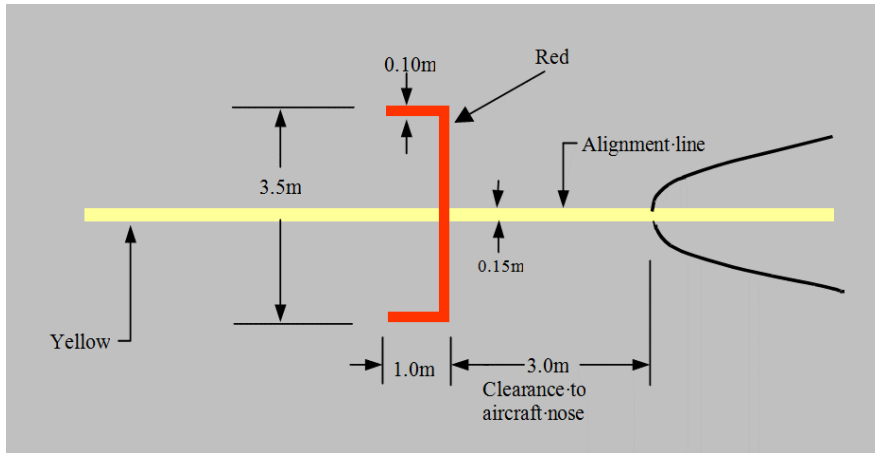
- (4) Despite subsection (3), push-back vehicle operator guidance markings may be based solely on the main wheel tracks, instead of the nose wheel, if:
  - (a) aircraft clearance to object requirements in Chapter 6 are maintained; and
  - (b) there is no hazard presented to aircraft operations; and
  - (c) relevant aircraft operators are consulted, and agree in writing, with the writing retained by the aerodrome operator and the agreement recorded in the aerodrome manual; and
  - (d) the push-back design methodology, and associated push-back safety procedures, are:
    - (i) communicated to the relevant aircraft operators and associated ground handling organisations; and
    - (ii) documented in the aerodrome manual.

### **8.71 Aircraft push-back lines**

- (1) The aircraft push-back line:
  - (a) subject to subsection 8.70 (4), must be based on the required path of the nose wheel of the aircraft with the reference code which the parking position is intended to serve; and
  - (b) must take the form of a line of dashes, with each dash being 1 m long, 0.15 m wide, coloured white, and with 1 m intervals between each dash.
- (2) If the push-back line is used for push-back operations with aircraft of reference code letter C, D or E, the 10 m section of line before the towbar disconnect marking must be straight.
- (3) If the entire length or a subsection of the push-back line is aligned with a lead-in line, the push-back line is to be omitted in favour of the primary lead-in line marking.

### **8.72 Tug push-back vehicle parking position line markings**

- (1) An aerodrome operator may provide a push-back vehicle parking position line marking.
- (2) The push-back vehicle parking position line marking must be such that a parked push-back vehicle is clear of incoming aircraft.
- (3) As shown in Figure 8.72 (3), the marking must consist of a continuous red line 0.10 m wide, marked in the shape of a half rectangle outline.
- (4) The long side of the rectangle must be 3.5 m and other sides 1 m long.
- (5) The push-back vehicle parking position line marking must commence a minimum of 3 m from the nose of the aircraft with the reference code which the parking position is intended to serve.
- (6) If the push-back vehicle parking position line marking needs to be marked with an alignment line marking, the push-back vehicle parking position line is the primary marking.

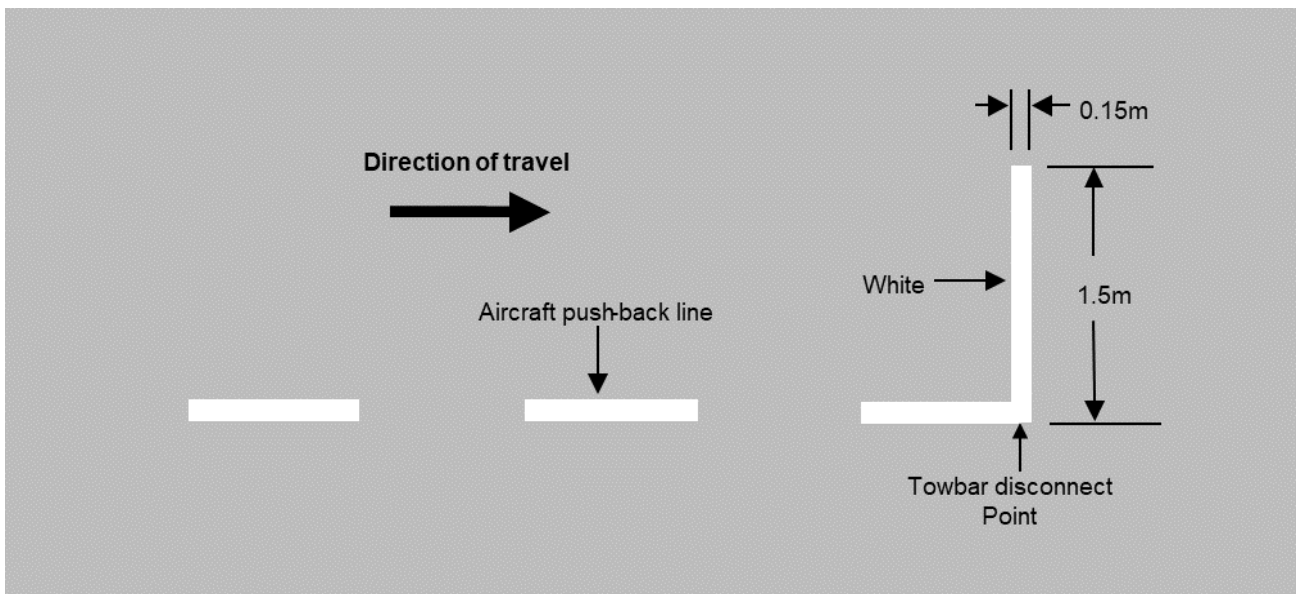


**Figure 8.72 (3) Push-back vehicle parking position line (shows matters)**

### 8.73 Towbar disconnect markings

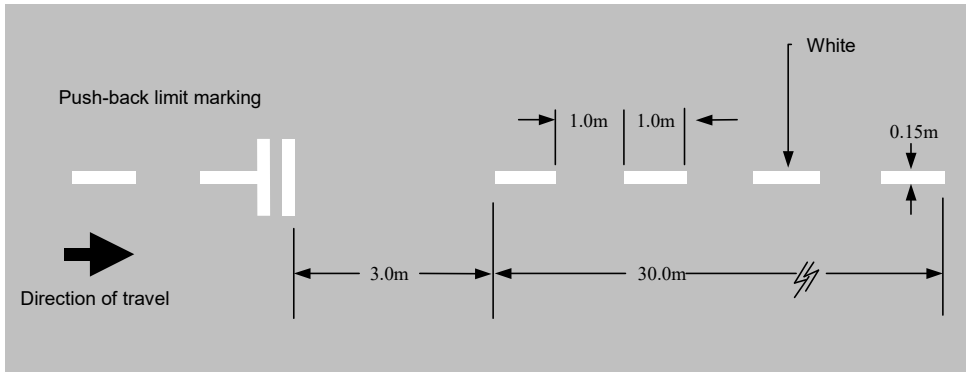
- (1) As shown in Figure 8.73 (1), the towbar disconnect marking must be located at the point of disconnection and must consist of a white line, 1.5 m long and 0.15 m wide.
- (2) The towbar disconnect marking must be located on the left-hand side of the taxi guideline or push-back line, as viewed from the push-back vehicle, touching the line and at right angles to it.
- (3) Towbar disconnect markings may be designated by the aerodrome operator.
- (4) If designations are provided, each designation must have a minimum height of 0.3 m and be clearly readable to the operator of the push-back vehicle.

*Note* CASA recommends that towbar disconnect markings are designated with an alphabetical suffix the same as the corresponding taxiway or taxilane and then annotated with a sequential number starting at 1.



**Figure 8.73 (1) Towbar disconnect marking (shows matters)**





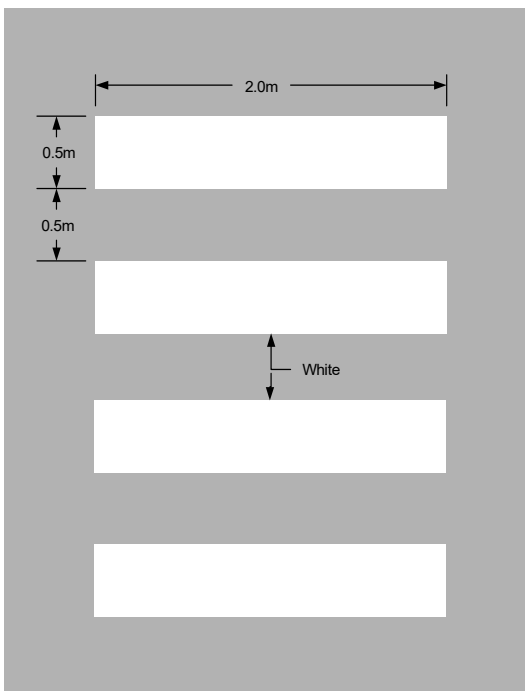
**Figure 8.75 (2) Push-back alignment bar marking (shows matters)**

### 8.76 Passenger path markings

- (1) Passenger path markings may be provided between a terminal building and an aircraft to assist the safe, secure and orderly movement of passengers embarking or disembarking.
- (2) Passenger path markings must be:
  - (a) marked as a series of white transverse lines, 0.5 m wide, at least 2 m long and 0.5 m apart, as shown in Figure 8.76 (2); or
  - (b) in accordance with the standards for patterns, colours and dimensions set by the relevant State or Territory roads authority for pedestrian crossing markings, as in force or existing from time to time, provided that the relevant State or Territory standard is referenced in the aerodrome manual.

*Note* Standards for patterns, colours and dimensions are available free online from the relevant State or Territory roads authority.

- (3) Pedestrians on the passenger path marking must be considered to be crossing the apron, and all vehicles, including those servicing aircraft, must give way to such pedestrian traffic.



**Figure 8.76 (2) Passenger path marking (shows matters)**

### 8.77 Miscellaneous area line markings

- (1) If:
  - (a) a marking is used on an area of a sealed, concrete or asphalt apron to define the area for a miscellaneous purpose; and
  - (b) a corresponding marking standard is not available in this MOS for that purpose;then the marking must consist of a continuous 0.15 m wide solid green line (a *miscellaneous area line marking*).
- (2) The purpose and location of a miscellaneous area line marking must be explained in the aerodrome manual.

*Note* Miscellaneous area line markings are typically used to delineate leased areas on the apron.

### 8.78 Hazardous area markings

- (1) A hazardous area marking may be used to denote a hazardous area on the apron surface, for example, an aerobridge drive zone, a pit cover or a fuel hydrant point.
- (2) The hazardous area marking boundary must be marked on the apron surface with a continuous red line that is 0.15 m wide.
- (3) The surface within the hazardous area marking boundary must be marked with red hatched lines that are:
  - (a) 0.15 m wide; and
  - (b) at a 45 degree angle to the line of a boundary; and
  - (c) equidistant from each other.

## CHAPTER 8

### Division 6 Movement area guidance signs (MAGS)

#### 8.79 Introduction

- (1) Movement area guidance signs (*MAGS*) may be:
  - (a) mandatory instruction signs; or
  - (b) information only signs.

*Note* In this Division, a general reference to a MAGS is a reference to any MAGS.
- (2) In this Division, unless the contrary intention appears:
  - (a) a reference to a “sign” is a reference to a MAGS; and
  - (b) a reference to “legend”, “face” and “installed” has the meaning given in paragraphs 8.82 (1) (a), (b) and (c), respectively.
- (3) Mandatory instruction MAGS must contain instructions that are:
  - (a) in white lettering on a red background; and
  - (b) to be obeyed by pilots.
- (4) MAGS with instructions must be provided:
  - (a) at international aerodromes with scheduled air transport operations; and
  - (b) at any aerodrome with ATC.
- (5) Information only MAGS convey information and must be:
  - (a) in black lettering on a yellow background; or
  - (b) in yellow lettering on a black background.
- (6) MAGS with information only must be provided at aerodromes where taxiway intersection departures are promulgated in the AIP.
- (7) Aerodrome operators must consult with airlines, and with ATC, on the need for MAGS with information.

#### 8.80 Naming of taxiway location signs

The following convention must be used in the naming of taxiway location signs:

- (a) a single letter must be used, without numbers, to designate each main taxiway;
- (b) the same letter must be used throughout the length of the taxiway, except where a turn of 90 degrees or more is made to join a runway, from whence a different letter may be assigned to the portion of the taxiway after the turn;
- (c) for each intersecting taxiway, a different single letter must be used;
- (d) to avoid confusion, the letters I, O and X must not be used;
- (e) the letter Q may be used — but only where other letters are not available;
- (f) at aerodromes with a large number of taxiways:
  - (i) alpha-numeric designators may be used for short intersecting taxiways; and

- (ii) successive intersecting taxiways must use the same letter, with sequential numbers; and
- (iii) if sequential numbers are not suitable (for example, due to the geometry of the taxiway system), the aerodrome operator must advise the AIS provider of the missing designators; and
- (iv) if it is necessary to use double-digit alpha-numeric designators, these must not use numbers associated with the runway designations at the aerodrome.

### 8.81 Dimensions and location

- (1) MAGS must be located to provide adequate clearance to passing aircraft.
- (2) If MAGS are provided on 1 side of the taxiway only, they must be located on the pilot's left-hand side.
- (3) Despite subsection (2), MAGS may be located on the pilot's right-hand side where it is not possible to locate the MAGS on the pilot's left-hand side due to 1 or more of the following:
  - (a) a physical obstacle;
  - (b) an unsuitable surface type;
  - (c) a visual obstruction.
- (4) If MAGS are to be read from opposite directions, they must be oriented so as to be at right angles to the taxi guideline.
- (5) If MAGS are to be read in 1 direction only, they must be oriented so as to be at 75 degrees to the taxi guideline.

### 8.82 Sign size and location distances, including runway exit signs

- (1) Sign size and location distances must be in accordance with Table 8.82 (1) where:
  - (a) **legend** means the height of the lettering within the sign, as measured in millimetres (**mm**); and
  - (b) **face** means the height of the sign face itself, as measured in mm; and
  - (c) **installed** means the height from ground level to the top of the installed sign, as measured in mm.
- (2) Despite subsection (1), the location distances may be exceeded if:
  - (a) excessive jet blast or propeller wash is experienced at the preferred or mandated location; and
  - (b) the alternate location is located outside all other runway and taxiway strips; and
  - (c) the alternate location can be clearly seen from the runway; and
  - (d) the alternate location does not create a hazard to aircraft operations.
- (3) For an information sign (I) or a mandatory instruction sign (M), as indicated in a row of column 2 of Table 8.82 (1), that is for an aerodrome with a code letter mentioned in the same row of column 1, the sign height, by type, legend, face, and installed, and the ranges of the perpendicular distance of the sign from the defined taxiway pavement edge to the near side of sign, and from the defined runway pavement edge to the near side of the sign, respectively, is the height or range mentioned in the same row in columns 3, 4, 5, 6, and 7, respectively.



**Table 8.82 (1) Sign size and location distances**

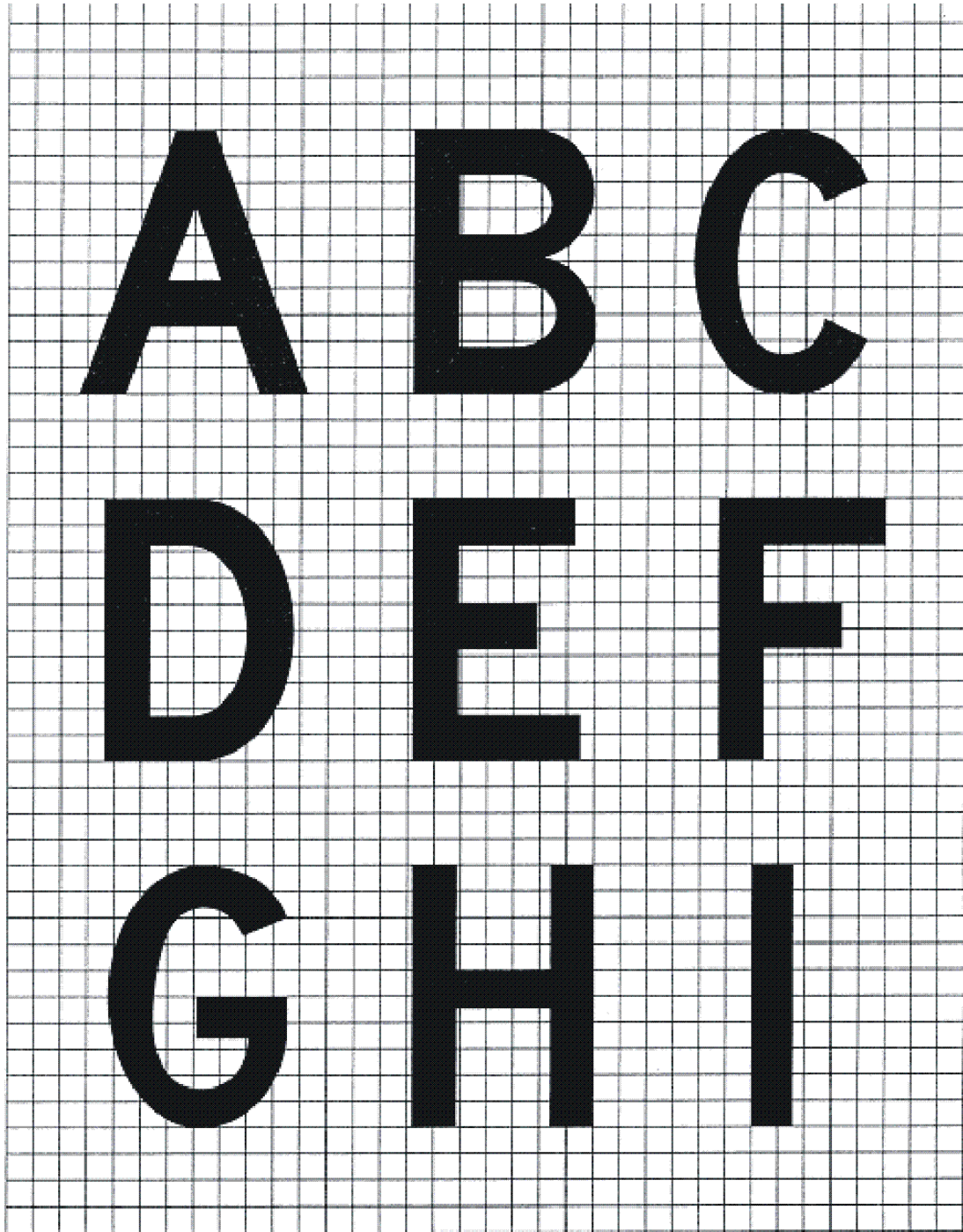
Code Number	Type of sign	Sign Height (mm)			Perpendicular distance from defined taxiway pavement edge to near side of sign	Perpendicular distance from defined runway pavement edge to near side of sign
		Legend	Face (min)	Installed (max)		
1 or 2 <sup>a</sup>	I	200	400	700	5 – 11 m	3 – 10 m
1 or 2	M	300	600	900	5 – 11 m	3 – 10 m
3 or 4 <sup>a</sup>	I	300	600	900	11 – 21 m	8 – 15 m
3 or 4	M	400	800	1100	11 – 21 m	8 – 15 m

- (4) In Table 8.82 (1), for an aerodrome code number with the superscript annotation “a”, runway exit information signs must be the same size as mandatory signs.
- (5) Where information is also provided on a mandatory instruction sign, the information sign must comply with the same size, location, and distance from the pavement edge as the mandatory instruction sign, in accordance with Table 8.82 (1).
- (6) For MAGS, the stroke width of letters and arrows must be such that for a letter or arrow height mentioned in a row of column 1 of Table 8.82 (6), the stroke width of the letter or arrow is the value mentioned in the same row in column 2.

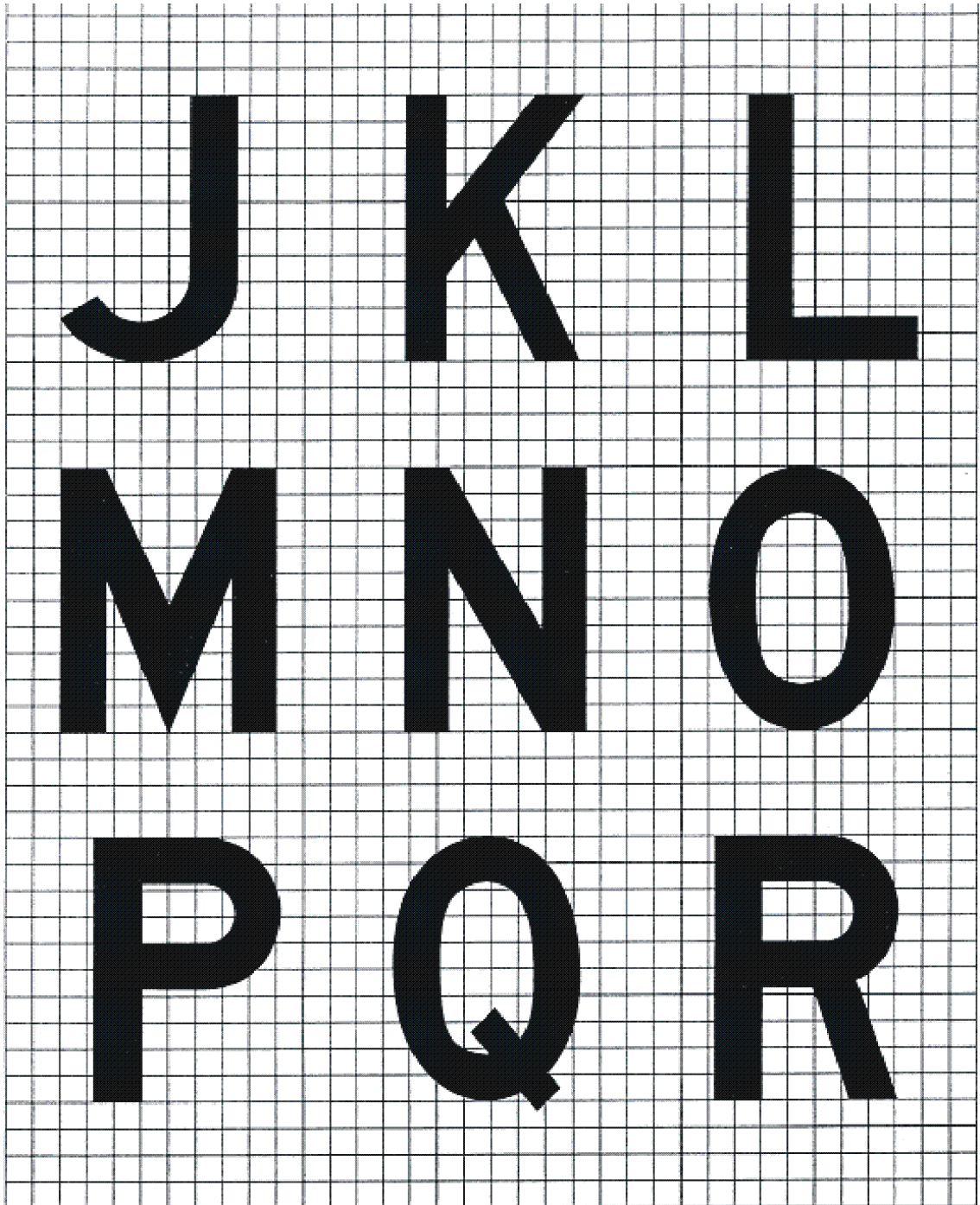
**Table 8.82 (6) Stroke width of letters and arrows**

Height	Stroke width
200 mm	32 mm
300 mm	48 mm
400 mm	64 mm

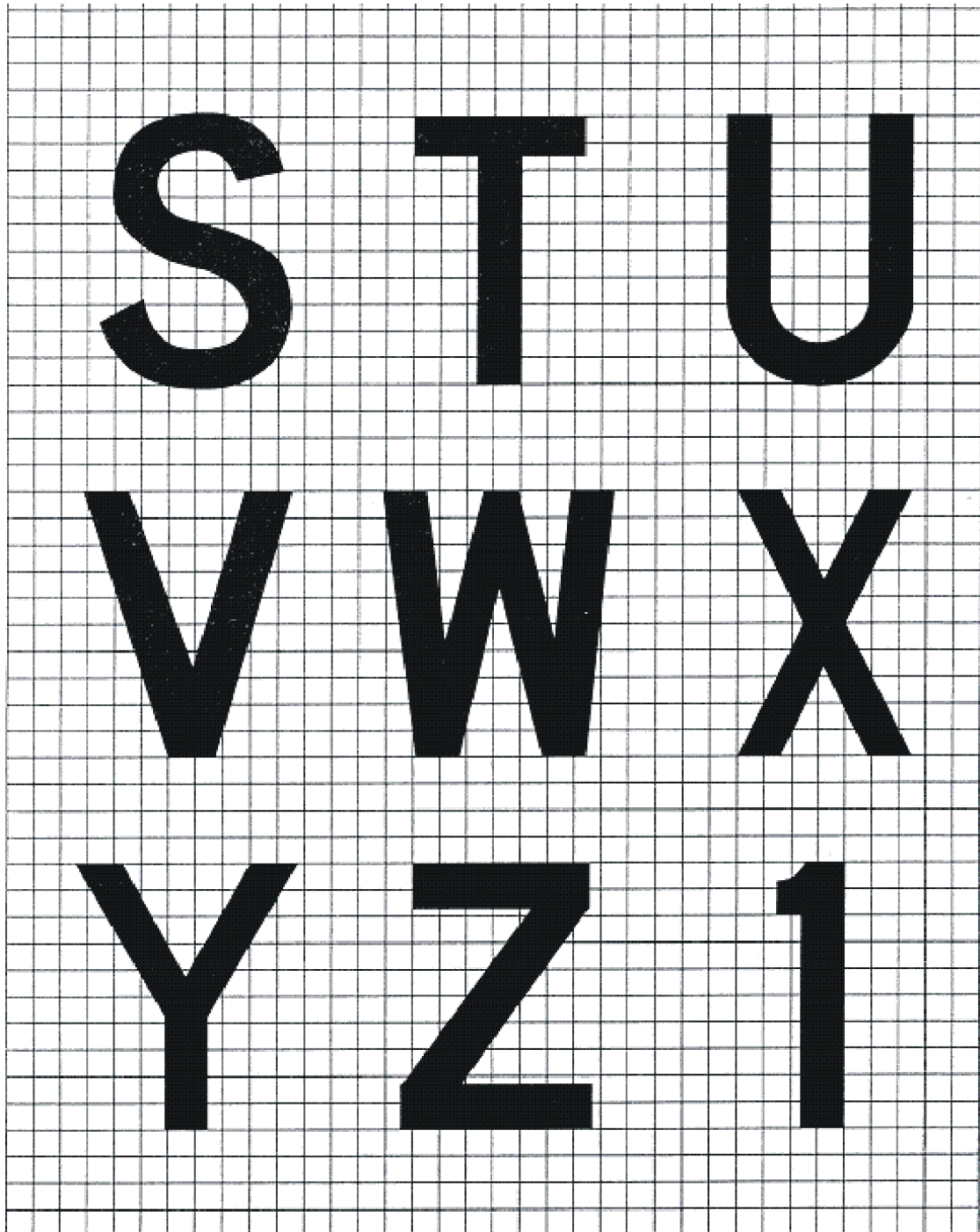
- (7) Subject to this section, the letters, numbers and symbols used on MAGS must conform in style and proportion as shown in Figures 8.82 (7)-1 to 8.82 (7)-7.



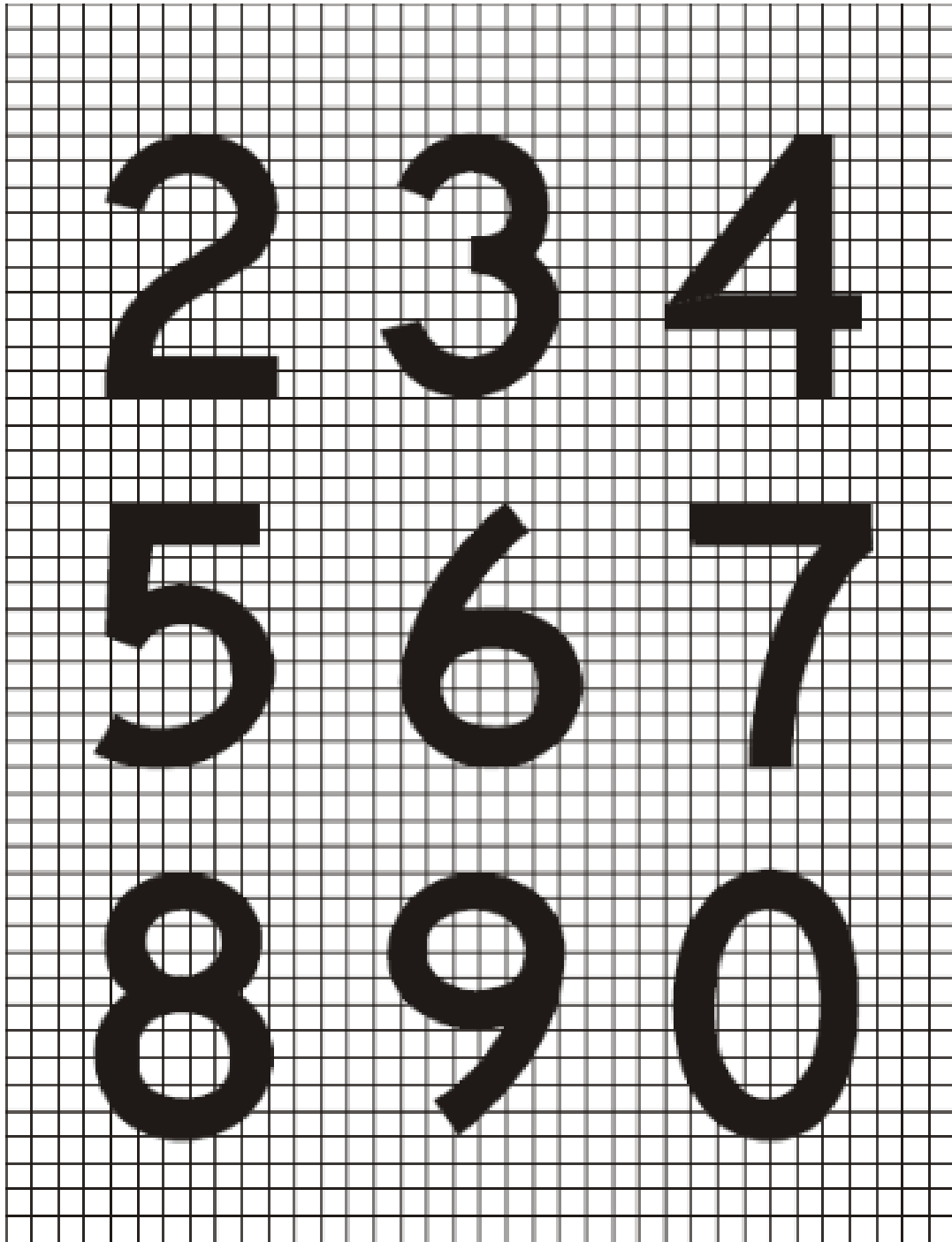
**Figure 8.82 (7)-1 Form and proportion of letters, numbers and symbols used on movement area guidance signs (shows matters)**



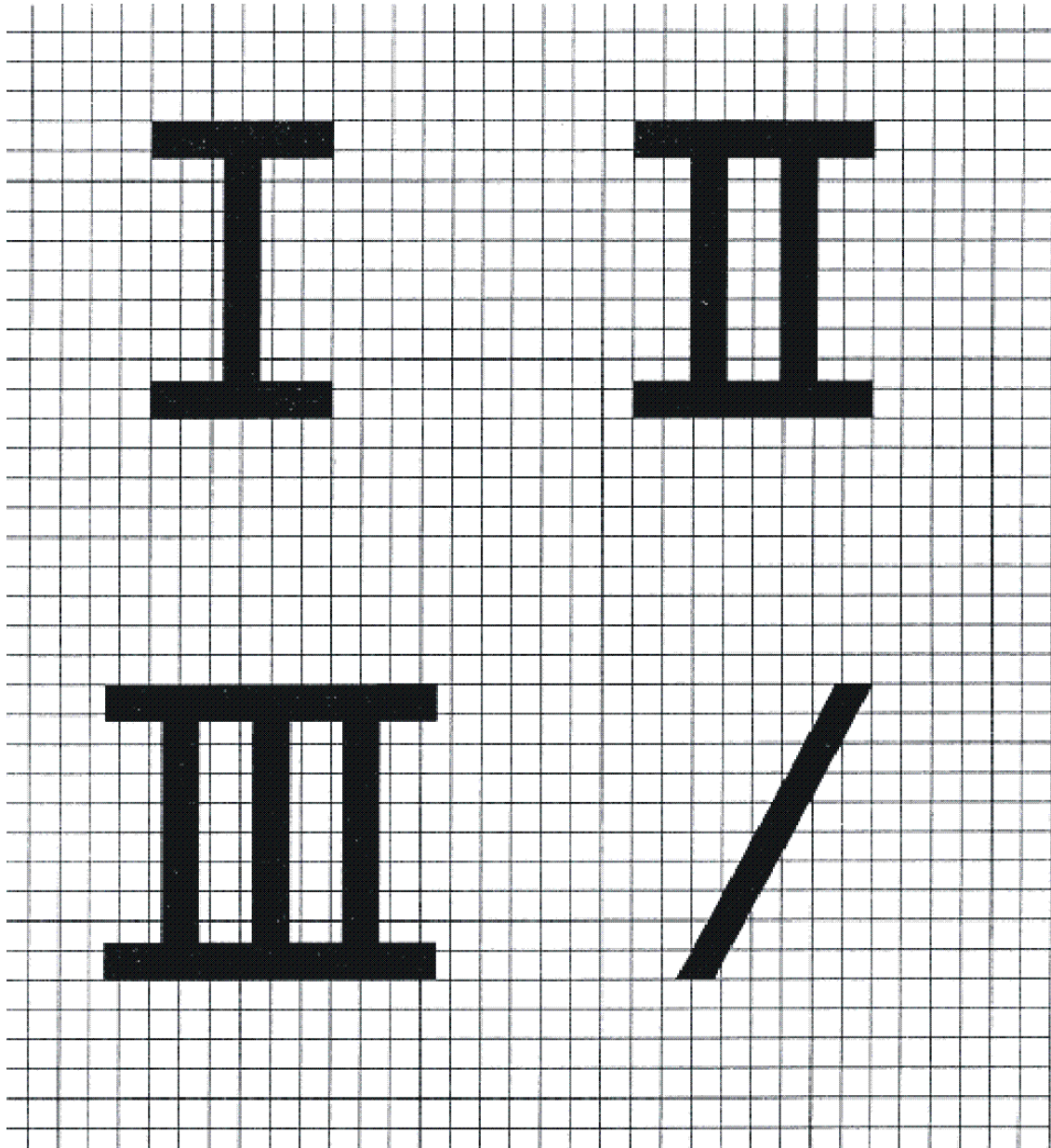
**Figure 8.82 (7)-2 Form and proportion of letters, numbers and symbols used on movement area guidance signs (shows matters)**



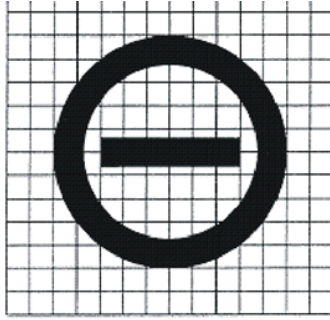
**Figure 8.82 (7)-3 Form and proportion of letters, numbers and symbols used on movement area guidance signs (shows matters)**



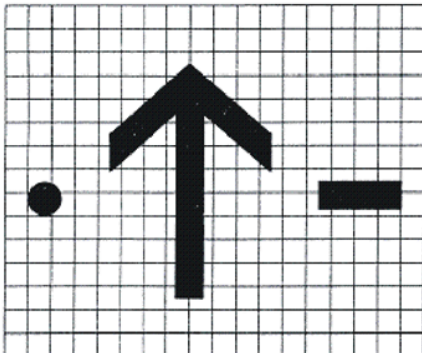
**Figure 8.82 (7)-4 Form and proportion of letters, numbers and symbols used on movement area guidance signs (shows matters)**



**Figure 8.82 (7)-5 Form and proportion of letters, numbers and symbols used on movement area guidance signs (shows matters)**



NO ENTRY sign



*Note 1* The arrow stroke width, diameter of the dot, and both width and length of the dash shall be proportioned to the character stroke widths.

*Note 2* The dimensions of the arrow shall remain constant for a particular sign size, regardless of orientation.

**Figure 8.82 (7)-6 Form and proportion of letters, numbers and symbols used on movement area guidance signs (shows matters)**

a) Letter to letter code number			
Preceding Letter	Following Letter		
	B, D, E, F, H, I, K, L, M, N, P, R, U	C, G, O, Q, S, X, Z	A, J, T, V, W, Y
	Code number		
A	2	2	4
B	1	2	2
C	2	2	3
D	1	2	2
E	2	2	3
F	2	2	3
G	1	2	2
H	1	1	2
I	1	1	2
J	1	1	2
K	2	2	3
L	2	2	4
M	1	1	2
N	1	1	2
O	1	2	2
P	1	2	2
Q	1	2	2
R	1	2	2
S	1	2	2
T	2	2	4
U	1	1	2
V	2	2	4
W	2	2	4
X	2	2	3
Y	2	2	4
Z	2	2	3

b) Numeral to numeral code number			
Preceding Numeral	Following number		
	1, 5	2, 3, 6, 8, 9, 0	4, 7
	Code number		
1	1	1	2
2	1	2	2
3	1	2	2
4	2	2	4
5	1	2	2
6	1	2	2
7	2	2	4
8	1	2	2
9	1	2	2
0	1	2	2

c) Space between characters			
Code No.	Character height (mm)		
	200	300	400
	Space (mm)		
1	48	71	96
2	38	57	76
3	25	38	50
4	13	19	26

d) Width of letter			
Letter	Letter height (mm)		
	200	300	400
	Width (mm)		
A	170	255	340
B	137	205	274
C	137	205	274
D	137	205	274
E	124	186	248
F	124	186	248
G	137	205	274
H	137	205	274
I	32	48	64
J	127	190	254
K	140	210	280
L	124	186	248
M	157	236	314
N	137	205	274
O	143	214	286
P	137	205	274
Q	143	214	286
R	137	205	274
S	137	205	274
T	124	186	248
U	137	205	274
V	152	229	304
W	178	267	356
X	137	205	274
Y	171	257	342
Z	137	205	274

e) Width of numeral			
Numeral	Numeral height (mm)		
	200	300	400
	Width (mm)		
1	50	74	98
2	137	205	274
3	137	205	274
4	149	224	298
5	137	205	274
6	137	205	274
7	137	205	274
8	137	205	274
9	137	205	274
0	143	214	286

**INSTRUCTIONS**

- To determine the proper SPACE between letters or numerals, obtain the code number from table a) or b) and enter table c) for that code number to the desired letter or numeral height.
- The space between words or groups of characters forming an abbreviation or symbol should be equal to 0.5 to 0.75 of the height of the characters used except that where an arrow is located with a single character such as 'A →', the space may be reduced to not less than one quarter of the height of the character in order to provide a good visual balance.
- Where the numeral follows a letter or vice versa use Code 1.
- Where a hyphen, dot, or diagonal stroke follows a character or vice versa use Code 1.
- For the intersection take-off sign, the height of the lower case "m" is 0.75 of the height of the preceding "0" (zero) and spaced from the preceding "0" at code 1 for the character height of the numerals.

**Figure 8.82 (7)-7 Form and proportion of letters, numbers and symbols used on movement area guidance signs (shows matters)**

**8.83 The face width of a sign**

- The face width of a sign must provide on either side of the legend a minimum width equal to half the height of the legend.
- In the case of a single-letter standalone sign, the face width must be increased to the height of the legend.



- (3) The face width of a mandatory instruction sign provided on 1 side of a taxiway only must not be less than:
  - (a) for a code 3 or 4 runway — 1.94 m; and
  - (b) for a code 1 or 2 runway — 1.46 m.

### 8.84 Structural

MAGS must be frangible in accordance with section 8.113.

### 8.85 Illumination

- (1) MAGS must be illuminated for the following:
  - (a) runways and associated taxiways at aerodromes with scheduled international air transport operations;
  - (b) runways and associated taxiways with:
    - (i) visual range conditions less than 800 m; or
    - (ii) RVR conditions less than 800 m.
- (2) MAGS may be illuminated for runways and associated taxiways at aerodromes that:
  - (a) do not have scheduled international air transport operations; and
  - (b) do have visual range conditions or RVR conditions equal to, or greater than, 800 m.
- (3) For runways and taxiways mentioned in subsection (2), a retroreflective sign may be used as an alternative to illumination, but not if the location of the sign would make a retroreflective sign ineffective.
- (4) Illumination:
  - (a) may be external or internal to the sign; and
  - (b) must not cause any visual hazard to aircraft and vehicles, for example, from glare or dazzle.
- (5) The average sign luminance must be as follows:
  - (a) for operations conducted in runway visibility, or RVR, of less than 800 m — the average sign luminance for the sign colour mentioned in a row of column 1 of Table 8.85 (5) (a) must be at least that mentioned in the same row in column 2;

**Table 8.85 (5) (a) Luminance for RVR of less than 800 m**

Sign Colour	Average sign luminance
Red	30 cd/m <sup>2</sup>
Yellow	150 cd/m <sup>2</sup>
White	300 cd/m <sup>2</sup>

- (b) for operations conducted at night, in RVR of 800 m or more — average sign luminance for the sign colour mentioned in a row of column 1 of Table 8.85 (5) (b) must be at least that mentioned in the same row in column 2.

**Table 8.85 (5) (b) Luminance for night operations with RVR of 800 m or more**

<b>Sign Colour</b>	<b>Average sign luminance</b>
Red	10 cd/m <sup>2</sup>
Yellow	50 cd/m <sup>2</sup>
White	100 cd/m <sup>2</sup>

- (6) The luminous ratio between the red and white elements of a mandatory instruction sign must not be less than 1:5 and not greater than 1:10.

*Note* CASA recommends that the average luminance of the MAGS be calculated in accordance with ICAO Annex 14, Aerodromes, Volume 1, Aerodrome Design and Operations, Appendix 4, Figure A4-1, as in force or existing from time to time. For ICAO documents, see section 1.07.

- (7) The comparative luminance values of adjacent grid cells within a sign must not exceed:
- (a) a ratio of 1.5:1 for grid cells that are 15 cm<sup>2</sup>; and
  - (b) a ratio of 1.25:1 for grid cells that are 7.5 cm<sup>2</sup>.

*Note* “Grid cells” within a sign is a variable construct which depends upon the technique being applied and the number of grid squares used.

- (8) The ratio between the maximum and minimum luminance value over the whole of a sign face must not exceed 5:1.
- (9) The sign specifically provided at an aerodrome for LAHSO must be illuminated when the lighting of the runway on which LAHSO are conducted is switched on.

*Note* MAGS specifically provided for LAHSO include, for example, runway/runway intersection signs and distance-to-go signs.

- (10) Runway exit signs that are required for LAHSO must be illuminated when LAHSO are conducted at night.

*Note* CASA recommends that signs use red, white, yellow and black colours that comply with the relevant recommendations in ICAO Annex 14, Aerodromes, Volume 1, Aerodrome Design and Operations, Appendix 1, for externally illuminated signs, retroreflective signs and transilluminated signs, as applicable. For ICAO documents, see section 1.07.

## **8.86 MAGS with mandatory instructions**

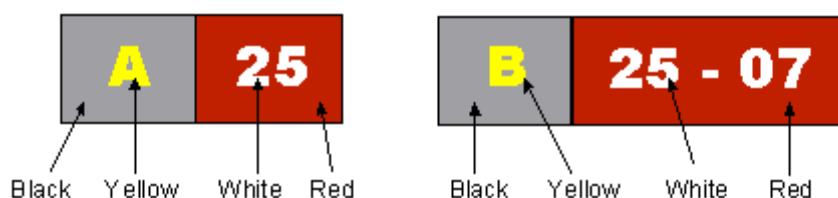
Mandatory instruction MAGS include the following:

- (a) runway designation signs;
- (b) CAT I, II or III holding position signs;
- (c) runway holding position signs;
- (d) aircraft NO ENTRY signs;
- (e) vehicular STOP signs;
- (f) runway/runway intersection signs.

## **8.87 Runway designation signs**

- (1) At the intersection of a runway with a taxiway with a pattern “A” runway holding position marking, a runway designation sign must be provided as illustrated in Figure 8.87 (1).

- (2) If the taxiway intersection is located at or near the end of the runway, only the designation for 1 end of the runway must be shown.
- (3) If the taxiway intersection is not located at or near the end of the runway, designations for both ends of the runway must be shown, properly orientated for each sign to be relevantly viewed.
- (4) A taxiway location sign must be provided alongside the runway designation sign, in the outboard (that is, farthest from the taxiway) position.
- (5) A runway designation sign must be provided on each side of the taxiway.
- (6) Despite subsection (5), a runway designation sign may be provided on only 1 side, preferably the left-hand side, if placement on both sides is prevented by any of the following:
  - (a) a physical obstacle;
  - (b) an unsuitable surface type;
  - (c) a visual obstruction.



**Figure 8.87 (1) Runway designation sign with taxiway location sign (illustrates matters)**

### 8.88 CAT I, II or III runway designation signs

- (1) For a CAT I, II or III runway, if a pattern “B” runway holding position marking is provided on a taxiway, a CAT I, II or III runway destination sign must be provided on each side of the taxiway, as illustrated in Figure 8.88 (1).
- (2) Despite subsection (1), a CAT I, II or III runway destination sign may be provided on only 1 side, preferably the left-hand side, if placement on both sides is prevented by any of the following:
  - (a) a physical obstacle;
  - (b) an unsuitable surface type;
  - (c) a visual obstruction.



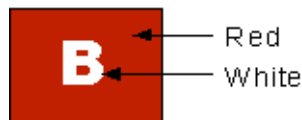
**Figure 8.88 (1) CAT I runway designation sign (illustrates matters)**

### 8.89 Runway holding position signs

- (1) A runway holding position sign must be provided at a taxiway location other than an intersection where ATC has a requirement for aircraft to stop.

*Note* For example, ATC may require aircraft to stop at an intersection where there is entry to an ILS sensitive area.

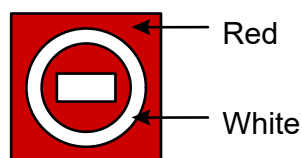
- (2) A runway holding position sign may be provided in other locations as a mitigation measure against the risk of a runway incursion event.
- (3) Where a runway holding position sign is provided under subsection (2), the location of the runway holding position sign must ensure the vehicle will hold clear of the runway in accordance with Chapter 6, Division 3 and Chapter 7 of this MOS.
- (4) A runway holding position sign is a taxiway designation sign, but with white lettering on a red background, as illustrated in Figure 8.89 (4).



**Figure 8.89 (4) Mandatory runway holding position sign (illustrates matters)**

### 8.90 Aircraft NO ENTRY signs

- (1) As illustrated in Figure 8.90 (1), an aircraft NO ENTRY sign, consisting of a white circle with a horizontal bar in the middle, on a red background, must be provided at the entrance to a prohibited area.
- (2) The NO ENTRY sign must be located on each side of the taxiway.
- (3) Despite subsection (2), a NO ENTRY sign may be provided on only 1 side, preferably the left-hand side, if placement on both sides is prevented by any of the following:
  - (a) a physical obstacle;
  - (b) an unsuitable surface type;
  - (c) visual obstruction.



**Figure 8.90 (1) Aircraft NO ENTRY sign (illustrates matters)**

### 8.91 Vehicle STOP signs

- (1) Vehicle STOP signs may be provided to prevent an inadvertent vehicle incursion into the movement area.
- (2) A vehicle STOP sign:
  - (a) must not be located within a runway or taxiway strip; and
  - (b) must not infringe the obstacle limitation surface.

*Note 1* See also sections 6.54 and 6.55 for the provision and location of a road-holding position.

*Note 2* CASA recommends that vehicle STOP signs comply with the standards, in force or existing from time to time, set by the roads authority of the State or Territory where the aerodrome is located.

## 8.92 Runway/runway intersection signs

- (1) Signs must be used to identify that a runway X intersects a runway Y ahead of an aircraft already on runway Y (*runway/runway intersection signs*).
- (2) Runway/runway intersection signs are runway designation signs provided on each side of a runway used in LAHSO.
- (3) Runway/runway intersection signs must:
  - (a) show the designation of the intersecting runway; and
  - (b) using a dash, indicate the respective intersecting runway thresholds, for example, “15-33”, indicates that runway threshold “15” is to the left, and runway threshold “33” is to the right; and
  - (c) be properly orientated for the sign to be relevantly viewed; and
  - (d) be located at the hold short line, which must be at least 75 m from the centreline of the intersecting runway.
- (4) The overall height of a runway/runway intersection sign above the ground, and offset from the edge of the runway pavement, must be such as to provide at least 300 mm clearance between the top of the sign and any part of any aircraft using the runway when the outer edge of the wheel of the aircraft is at the runway pavement edge.

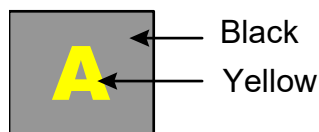
## 8.93 MAGS with information

Information MAGS include the following:

- (a) taxiway location signs;
- (b) direction signs;
- (c) destination signs;
- (d) take-off run available signs;
- (e) runway exit signs;
- (f) distance-to-go signs;
- (g) LAHSO distance-to-go signs.

## 8.94 Taxiway location signs

- (1) A taxiway location sign:
  - (a) is for the presentation of taxiway location information to an aircraft or vehicle on the taxiway; and
  - (b) is normally provided in conjunction with a direction sign or a runway designation sign.
- (2) A taxiway location sign must consist of yellow letters, numbers or symbols on a black background, as illustrated in Figure 8.94 (2).



**Figure 8.94 (2) Taxiway location sign (illustrates matters)**

Note In Figure 8.94 (2), the background appears as grey but this is only for contrast clarity. At an aerodrome, a taxiway location sign must have a black background.

### 8.95 Taxiway direction signs

- (1) A taxiway direction sign is to indicate the presence of an intersecting taxiway.
- (2) The taxiway direction must be indicated on the direction sign by an arrow, as illustrated in Figure 8.95 (2).
- (3) The direction sign must have black letters on a yellow background.
- (4) The direction sign must be complemented by a location sign.
- (5) Despite subsection (4), the location sign may be omitted if the taxiway designation is displayed on previous location signs along the taxiway.

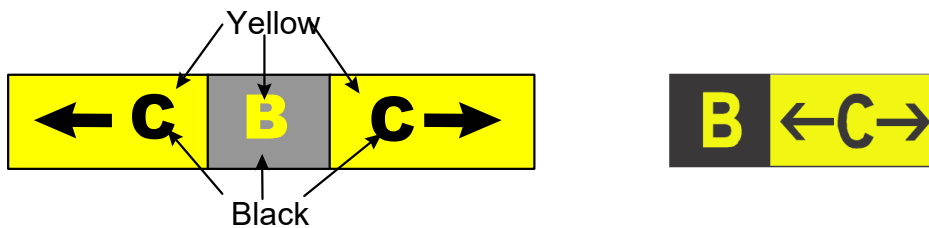


Figure 8.95 (2) Taxiway direction/location/direction sign (illustrates matters)

- (6) At the intersection of a taxiway with another taxiway (a *taxiway/taxiway intersection*), information MAGS must be located before the intersection and in line with the taxiway intersection marking.

### 8.96 Destination signs

- (1) Destination signs may be provided at an aerodrome to advise pilots of facilities on, or near, the movement area.
- (2) Destination signs must take the form of black letters on a yellow background, as illustrated in Figure 8.96 (2).



Figure 8.96 (2) Destination sign (illustrates matters)

- (3) A destination sign must not be co-located with a location or direction sign.
- (4) The sign text used for destination signs may include the text set out in Table 8.96 (4) where the text in a row of column 1 has the meaning given in the same row in column 2.

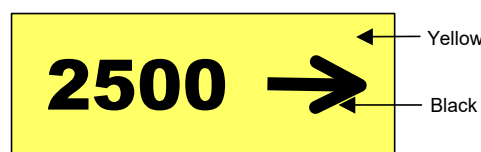
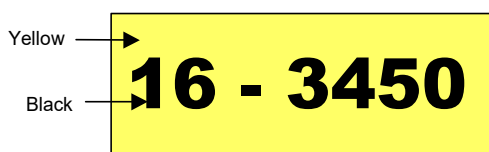
Table 8.96 (4) Common sign texts and their meaning

Sign text	Meaning
RAMP or APRON	General parking, servicing and loading areas
PARK or PARKING	Aircraft parking area
CIVIL	Civilian areas of joint-use aerodromes
MIL	Military area of a joint-use aerodrome
CARGO	Freight or cargo handling area

Sign text	Meaning
INTL	International areas
DOM	Domestic areas
RUNUP	Run-up areas
AC	Altimeter check point
VOR	VOR check point
FUEL	Fuel or service area
HGR	Hangar or hangar area

### 8.97 Take-off run available signs

- (1) A take-off run available sign is to indicate to pilots the length of take-off run available from a particular taxiway from which the AIP indicates that an intersection departure is available.
- (2) A take-off run available sign must be provided as a final reassurance to the pilot of an aircraft that the pilot is at the correct take-off location.
- (3) Take-off run available signs must be located abeam the runway holding position on the entry taxiway.
- (4) If 1 take-off run available sign is provided, it must be located on the left-hand side of the taxiway.
- (5) If take-off is available in both directions, 2 signs must be used, located 1 on each side of the taxiway, corresponding to the direction of take-off.
- (6) A take-off run available sign must not obscure a pilot's view of any mandatory instruction MAGS.
- (7) If the start of a take-off run for an intersection departure is close to the start of a runway, the take-off run available sign must show:
  - (a) the designation of the take-off runway; and
  - (b) the take-off run available in metres, as illustrated in Figure 8.97 (7).
- (8) If the take-off run for an intersection departure is not close to the start of the runway, the sign must show:
  - (a) the take-off run available in metres; and
  - (b) an arrow indicating the direction in which the take-off run is available, as illustrated in Figure 8.97 (8).
- (9) If intersection departures are available in both directions from an intersection departure position reported by the aerodrome operator, a take-off run available sign must be provided for each direction of take-off.

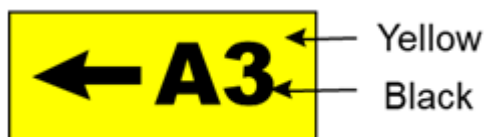


**Figure 8.97 (7) Take-off run available sign (illustrates matters)**

**Figure 8.97 (8) Take-off run available sign (illustrates matters)**

### 8.98 Runway exit signs

- (1) Subject to subsection (4), an aerodrome operator may provide a runway exit sign to advise pilots of the designation and direction of a taxiway from which they can exit a runway.
- (2) A runway exit sign must consist of black lettering on a yellow background, with a black arrow separated from the taxiway designator and pointing to the right of the designator for exits to the right, and to the left for exits to the left, as illustrated in Figure 8.98 (2).



**Figure 8.98 (2) Runway exit sign (illustrates matters)**

- (3) A runway exit sign must be located on the side of the exit taxiway as follows:
  - (a) for a code 3 or 4 runway — 60 m before the exit junction;
  - (b) for a code 1 or 2 runway — 30 m before the exit junction.
- (4) Runway exit signs must be provided for a runway used in LAHSO, unless the runway is provided only for aircraft below 5 700 kg MTOW.

### 8.99 LAHSO distance-to-go signs

- (1) LAHSO distance-to-go signs must be provided at a runway where runway geometry prevents a pilot engaged in LAHSO from readily and clearly seeing the hold short line.
- (2) LAHSO distance-to-go signs must:
  - (a) be provided on the left-hand side of the runway as seen by the landing pilot; and
  - (b) display increments of 300 m from the hold short line.
- (3) For LAHSO distance-to-go signs:
  - (a) there must be 3 signs, each appropriately marked with 1 of the following sets of numerals to show the metric distance-to-go:
    - (i) 300;
    - (ii) 600;
    - (iii) 900; and
  - (b) below each set of numerals, the designation of the intersecting runway must be displayed in smaller characters, as illustrated in Figure 8.99 (3); and
  - (c) the letters and numbers used in the sign must be in black on a yellow background; and
  - (d) the height of the distance numerals must be 600 mm and the height of the runway designation must be 200 mm.





**Figure 8.99 (3) Distance-to-go sign (illustrates matters)**

### **8.100 Parking position identification signs**

A parking position identification sign must:

- (a) be provided at an aircraft parking position that is equipped with a VDGS; and
- (b) be located so as to be clearly visible from the cockpit of an approaching aircraft before it turns into the parking position; and
- (c) consist of a numeric, or alpha-numeric, inscription denoting the parking position that is either:
  - (i) in white on a black background; or
  - (ii) in black on a yellow background.

*Note* The illumination requirements for parking position identification signs are contained in subsections 9.126 (4) and (5).

## CHAPTER 8

### Division 7 Wind direction indicators

#### 8.101 Requirements

- (1) An aerodrome operator:
  - (a) must install and maintain at least 1 wind direction indicator at the aerodrome, unless this MOS requires the installation of more than 1 wind direction indicator; and
  - (b) may install and maintain wind direction indicators additional to those required under paragraph (a) in accordance with the requirements of this subsection.
- (2) A wind direction indicator must be visible from aircraft:
  - (a) in flight; or
  - (b) on the manoeuvring area.
- (3) A wind direction indicator must be such that it is not affected by the effects of any air disturbance caused by buildings or other structures.
- (4) A wind direction indicator must be provided at the threshold of an instrument runway.
- (5) Despite subsections (2) and (4), for a runway that is not more than 1 200 m in length, the wind direction indicator may be centrally located provided it is visible from:
  - (a) both approaches; and
  - (b) the aircraft parking area.
- (6) The location required by subsection (4) does not apply to an instrument runway if surface wind information is communicated to pilots of aircraft approaching the runway by:
  - (a) ATC; or
  - (b) an aerodrome weather observing system that:
    - (i) is a Bureau of Meteorology-approved weather observing system; and
    - (ii) provides surface wind information through an aerodrome weather information broadcast; or
  - (c) an approved observer with a communication link to pilots through which timely information about surface wind may be passed; or
  - (d) any other means approved in writing by CASA.

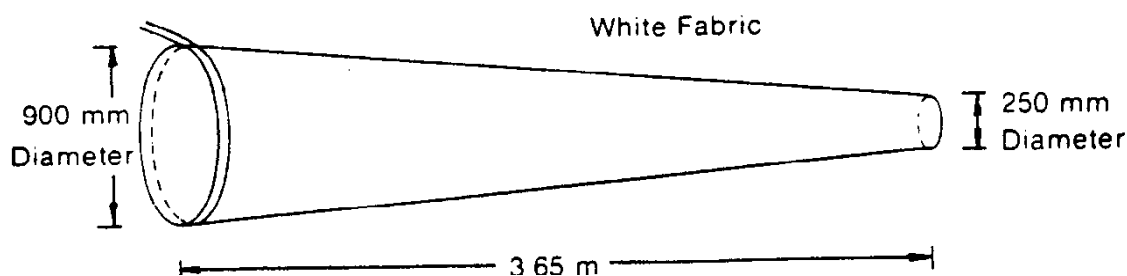
*Note* Despite subsection (6), locating a wind direction indicator at the threshold is recommended as such a visual aid provides immediate indication of wind direction and speed to pilots at the critical phase of the landing.
- (7) A wind direction indicator provided at the threshold of an instrument runway must be located as follows:
  - (a) on the left-hand side of the threshold as seen from a landing aircraft;
  - (b) outside the runway strip;
  - (c) clear of the transitional obstacle limitation surface;
  - (d) 100 m upwind of the threshold.

- (8) Despite paragraphs (7) (a) and (d), a wind direction indicator may be located on the right-hand side of the threshold, and up to 200 m upwind, if the left-hand side location 100 m upwind of the threshold is obstructed by:
  - (a) a taxiway, a navigational aid or a similar obstruction; or
  - (b) a structure or obstacle which is assessed, by CASA or a person approved in writing by CASA, as interfering with natural wind effects.
- (9) Despite subsections (7) and (8), a wind direction indicator provided at the threshold of an instrument runway may be located as approved in writing by CASA.

### 8.102 Standards for wind direction indicators

- (1) A wind direction indicator must consist of a tapering fabric sleeve with the widest end attached to a pole at an attachment point which ensures that the centroid of the sleeve is as close as possible to being 6.5 m above the ground.
- (2) The sleeve must be 3.65 m long and taper uniformly from 900 mm in diameter to 250 mm in diameter, as illustrated in Figure 8.102 (2).
- (3) The widest end of the sleeve must be mounted on a rigid frame that:
  - (a) keeps the end of the sleeve open; and
  - (b) keeps the sleeve attached to the pole; and
  - (c) allows the sleeve to move freely through 360 degrees around the pole.
- (4) The fabric of the sleeve must be of a conspicuous colour, preferably white, except that white fabric must not be used if its visibility is affected by snow or other contaminant on the movement area.

*Note* Natural or synthetic fibres within the weight range of 270 to 275 g/m<sup>2</sup> have been used effectively as wind direction indicator sleeve material.



**Figure 8.102 (2) Wind direction indicator (illustrates matters)**

- (5) At a non-controlled aerodrome, or an aerodrome without a 24 hour ATC service, the pole of at least 1 wind direction indicator must be located in the centre of a circle (the **background circle**) on the ground which provides a background contrast for the colour of the sleeve.
- (6) The background circle must be:
  - (a) 15 m in diameter; and
  - (b) coloured black; and
  - (c) bordered by:
    - (i) a white perimeter 1.2 m wide; or

- (ii) a ring of at least 8 equally-spaced white markers, each with a base not less than 0.75 m in diameter.

*Note* For the illumination of wind direction indicators, see section 9.38.

- (7) At aerodromes with more than one wind direction indicator, any additional wind direction indicators mentioned in paragraph 8.101 (1) (b) must comply with subsections (1), (2), (3) and (4) (of this section) except that the sleeve colour may be:
  - (a) if not illuminated at night — a conspicuous colour other than white, preferably yellow or orange; and
  - (b) if illuminated at night — white (subject to subsection (4)), or another contrasting colour which is clearly visible when illuminated.

## CHAPTER 8

### Division 8 Ground signals

#### 8.103 Signal areas

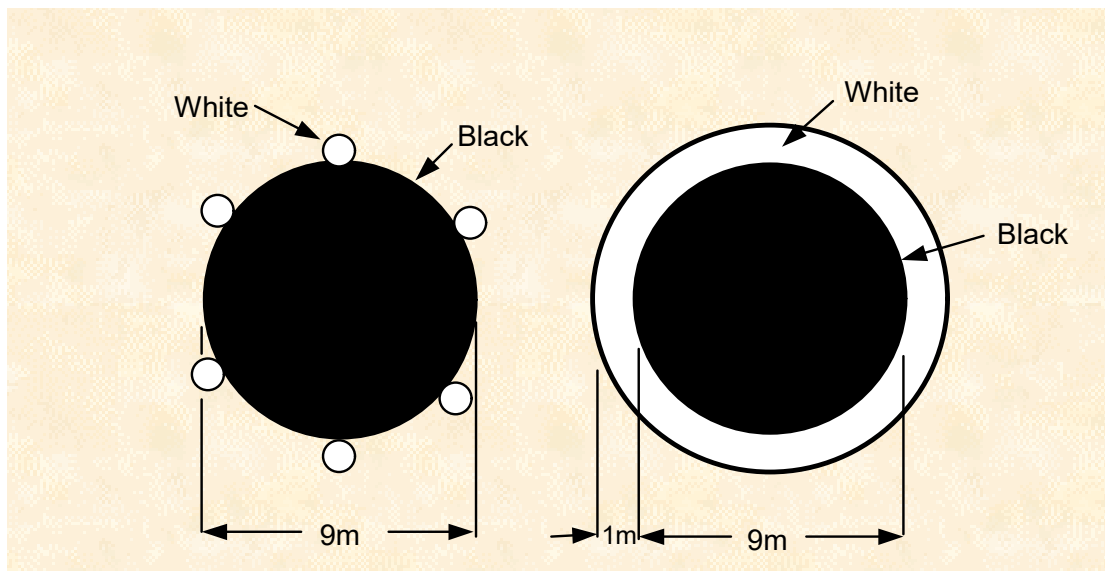
- (1) A signal area may be provided in conjunction with 1 wind direction indicator.

*Note* Provision of a signal area is optional. It is neither compulsory nor necessary because of the requirements for radio carriage and use at certified aerodromes under regulation 166E of CAR, and the requirement for NOTAMs to be issued for the aerodrome in the event of changes to conditions. A signal area would be unnecessary if a 24-hour ATC service is provided at the aerodrome.

- (2) A signal area must be:
  - (a) 9 m in diameter; and
  - (b) black in colour; and
  - (c) bordered by:
    - (i) a white border 1 metre wide; or
    - (ii) a minimum of 5 equally-spaced white markers, each with a base not less than 0.75 m in diameter; and

*Note* See the illustration in Figure 8.103 (2).

- (d) not more than 15 m from:
  - (i) the wind direction indicator; or
  - (ii) the additional wind direction indicator located closest to the apron of the aerodrome.

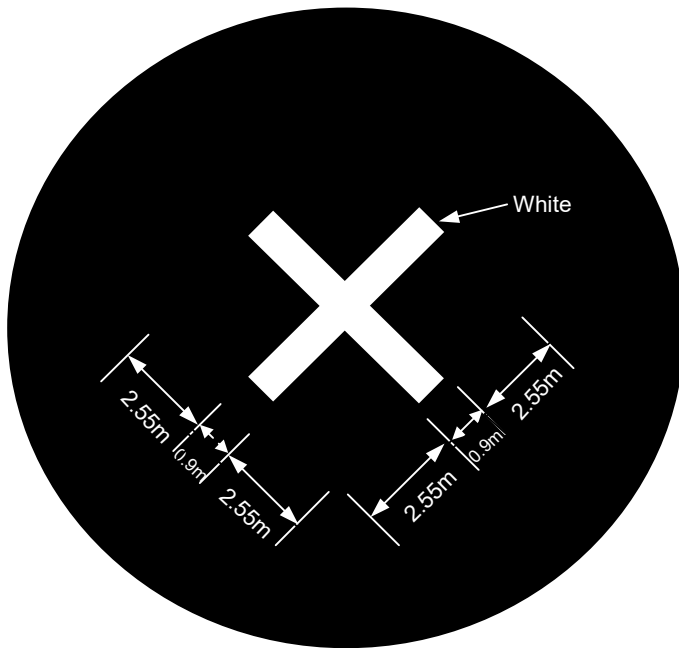


**Figure 8.103 (2) Signal area (illustrates matters)**

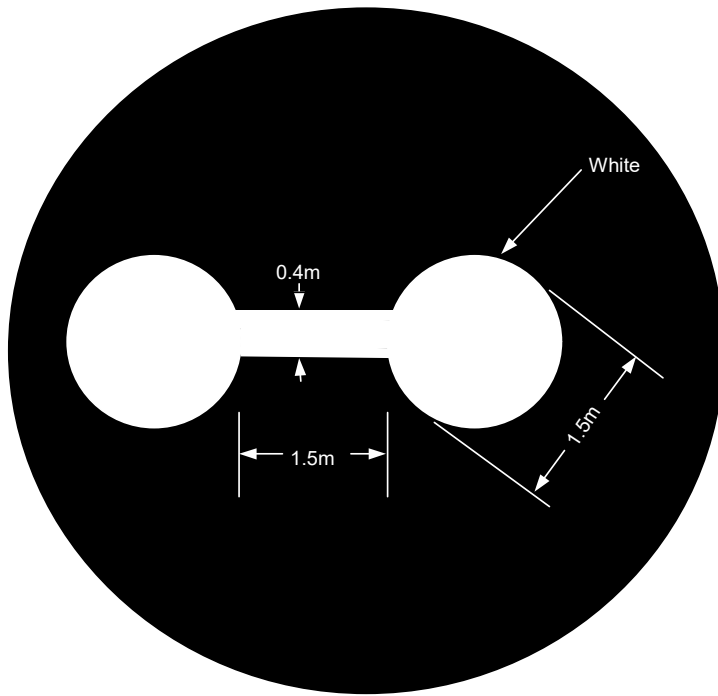
#### 8.104 Ground signals in signal areas

- (1) This section applies only if a signal area is provided.
- (2) A “total unserviceability” signal must be displayed in a signal area when an aerodrome is closed to landing aircraft.

- (3) As shown in Figure 8.104 (3), a “total unserviceability” signal must consist of 2 white stripes, 0.9 m wide and 6 m long, bisecting each other at right angles.
- (4) A “restricted operations” signal must be displayed in a signal area at an aerodrome with more than 1 type of surface on its movement area, to indicate whether aircraft are only to use:
  - (a) the sealed runways, taxiways and aprons; or
  - (b) if there are no sealed runways — the gravel runways.
- (5) As shown in Figure 8.104 (5), a “restricted operations” signal must consist of 2 white circles, each 1.5 m in diameter, connected by a white crossbar 1.5 m long and 0.4 m wide.



**Figure 8.104 (3) Total unserviceability signal (shows matters)**



**Figure 8.104 (5) Restricted operations signal (shows matters)**

## CHAPTER 8

### Division 9 Markings for unserviceable areas and works areas

#### 8.105 Introduction

This Division provides for:

- (a) the markings for an unserviceable area of a runway, taxiway, apron or holding bay; and
- (b) the markers for:
  - (i) the boundary of an unserviceable area; and
  - (ii) the limits of a works area.

#### 8.106 Markings for unserviceable runways, taxiways and other movement areas

##### General

- (1) Subject to sections 8.107 and 9.128, an unserviceability marking must be displayed on a runway or taxiway, or on that portion of a runway or taxiway, which is unserviceable.

*Note* The unserviceability markings mentioned in this section are not to be confused with unserviceability markers mentioned in Table 8.07 (3)-1 and section 8.108.

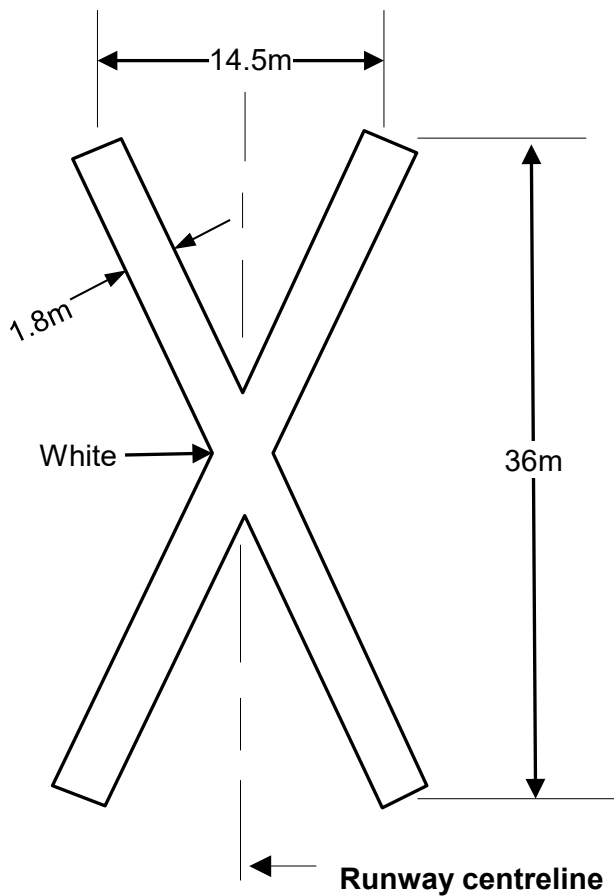
- (2) An unserviceability marking must be:
  - (a) when displayed on a runway — white; and
  - (b) when displayed on a taxiway — yellow.
- (3) When a runway is covered in snow or other contaminant, a more conspicuous colour than white must be used for the unserviceability markings.
- (4) If a runway or a taxiway, or a portion of a runway or a taxiway, or any other part of the movement area, is unserviceable because it is permanently closed, all runway and taxiway markings must be obliterated except for those markings used in accordance with this section to indicate the unserviceability.
- (5) Any temporary unserviceability markings that are not in the form of paint or a comparable substance must be appropriately secured or weighted against the hazards of jet blast, propeller wash or high winds.

##### Runways

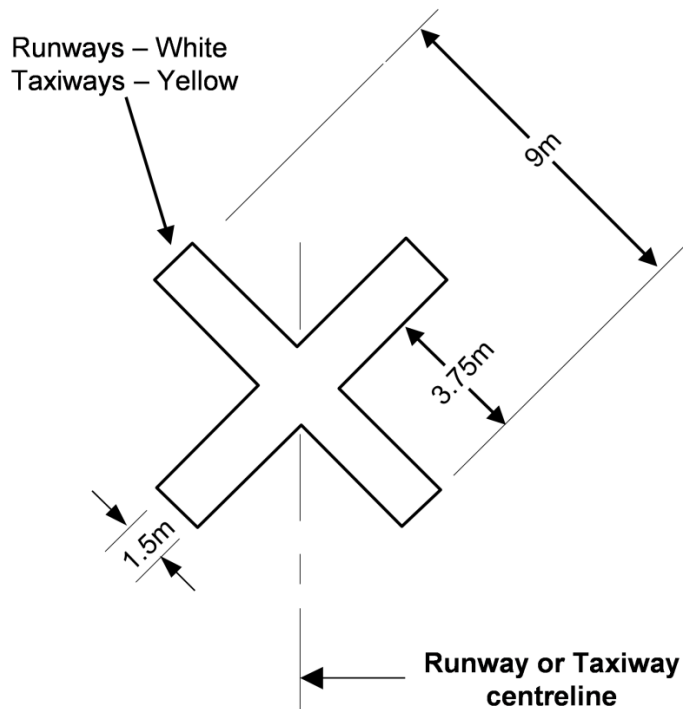
- (6) On a runway, an unserviceability marking must be placed at each end of the runway, or portion of a runway, that is declared unserviceable.
- (7) On a runway, additional unserviceability markings must be placed so that the maximum interval between markings does not exceed 300 m.
- (8) For a permanent closure of a runway, the unserviceability marking must have the form and proportions shown in Figure 8.106 (8).
- (9) For a temporary closure of a runway, the unserviceability marking must have the following form and proportions:
  - (a) for a runway whose width is more than 30 m — as shown in Figure 8.106 (8);
  - (b) for a runway whose width is more than 18 m but less than or equal to 30 m — as shown in Figure 8.106 (9)-1;



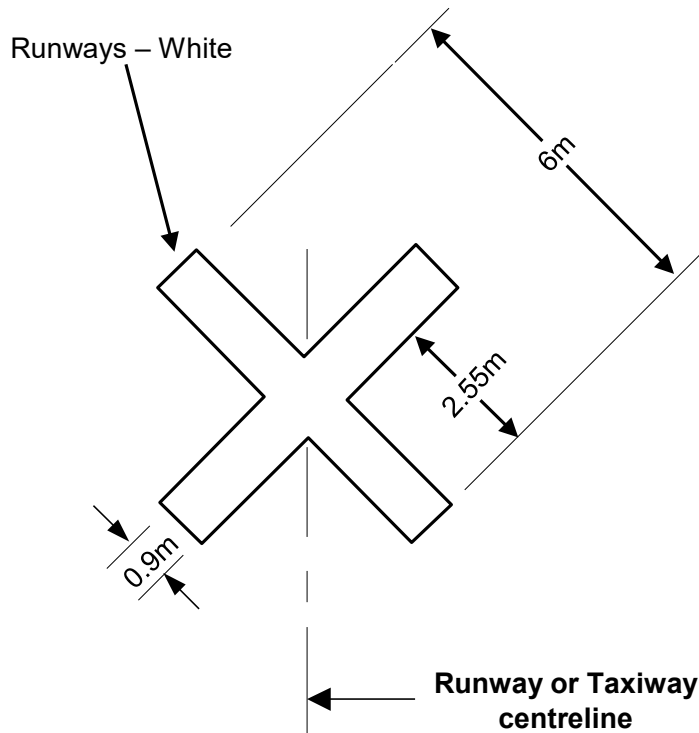
(c) for a runway whose width is 18 m — as shown in Figure 8.106 (9)-2.



**Figure 8.106 (8) Unserviceability marking — temporary closures for runways of width > 30 m and for permanent closures of all runway widths (shows matters)**



**Figure 8.106 (9)-1 Unserviceability marking — temporary closures for runways of 18 m < width ≤ 30 m and taxiways, and for permanent closures of all taxiways (shows matters)**



**Figure 8.106 (9)-2 Unserviceability marking — temporary closures for runways of 18 m width (shows matters)**

#### Taxiways

- (10) On a taxiway, an unserviceability marking must be placed:
  - (a) at each end of the unserviceable taxiway or portion of the taxiway; and
  - (b) if a taxiway serves an unserviceable runway or an unserviceable portion of a runway — so as to warn against entry to the unserviceable runway or unserviceable portion of the runway.
- (11) For a permanent closure of a taxiway, the unserviceability marking must have the form and proportions shown in Figure 8.106 (9)-1.
- (12) For a temporary closure of a taxiway, a taxiway unserviceability marking may be used but if used it must have the form and proportions shown in Figure 8.106 (9)-1.

### 8.107 When unserviceability markings are not required

- (1) Unserviceability markings are not required for a permanent taxiway closure if:
  - (a) an aircraft NO ENTRY sign is displayed at any entrance to the taxiway, as described in subsection 8.90 (1); and
  - (b) subsection 8.106 (4) is complied with for the taxiway; and
  - (c) for aerodromes available for night operations — a no entry bar is provided as described in section 9.108.

*Note* CASA recommends that for non-permanent taxiway closures in excess of 5 days' duration at international aerodromes and aerodromes with frequent aircraft movements, taxiway unserviceability markings be used.

- (2) Unserviceability markings are not required for time-limited works if the works are otherwise in accordance with a method of working plan (MOWP) under section 15.02.
- (3) Unserviceability markings are not required for an unserviceable full-length runway at a controlled aerodrome if:
  - (a) lighted visual aids are used in place of unserviceability markings in the pattern described in subsections 9.128 (3) and (4); and
  - (b) the lighted visual aids are used for a maximum duration of 24 hours at which time unserviceability markings must be used.
- (4) Unserviceability markings on an unserviceable runway are not required if:
  - (a) for works occurring during hours of darkness — the closure does not extend for more than 45 minutes into the hours of following daylight; and  
*Note* Daylight is defined as the period between the beginning of morning civil twilight and the end of evening civil twilight. See Chapter 3, Definitions etc.
  - (b) for all other works:
    - (i) the runway unserviceability is of less than 24 hours' duration; and
    - (ii) the total works period does not exceed 5 days' duration; and
    - (iii) a NOTAM is issued;

provided that:

- (c) at a controlled aerodrome — ATC has been requested to broadcast information to aircraft regarding the runway unserviceability or the location of a displaced threshold; and
- (d) at a non-controlled aerodrome — a vehicle used by a works safety officer supervising aerodrome works is equipped with a radio which allows for emergency 2-way communication with aircraft; and
- (e) at any aerodrome, in the event of a total aerodrome closure — a total unserviceability signal, in accordance with the standards under section 8.104, is displayed in the aerodrome's signal area (if provided).

*Note* 24 hours is the maximum closure period before unserviceability markings are required. However, international aerodromes and aerodromes with frequent aircraft movements are recommended to display unserviceability markings within this period.

### **8.108 Use of unserviceability markers**

- (1) Unserviceability markers must consist of a white standard cone:
  - (a) with a horizontal red stripe 25 cm wide around its centre halfway up the cone so as to provide 3 bands of colour, namely, white-red-white; and
  - (b) otherwise in accordance with subsection 8.07 (2).
- (2) Unserviceability markers must be placed at the entrance to, and across, any part of the movement area of an aerodrome (including a runway) that is not to be used by aircraft.

*Note* See Chapter 9, Division 14, for lighting associated with closed and unserviceable areas.

- (3) At least 3 unserviceability markers must be displayed across the centreline of any portion of a taxiway, apron or holding bay that is unserviceable, whether or not it is possible for aircraft to safely taxi past the area that is unserviceable.
- (4) Any unserviceability markers must be appropriately secured or weighted against the hazards of jet blast, propeller wash or high winds.

*Note* CASA recommends that additional unserviceability markers be displayed, 3 m apart, continuously across the entire width of the runway, taxiway, apron or holding bay.

## CHAPTER 8

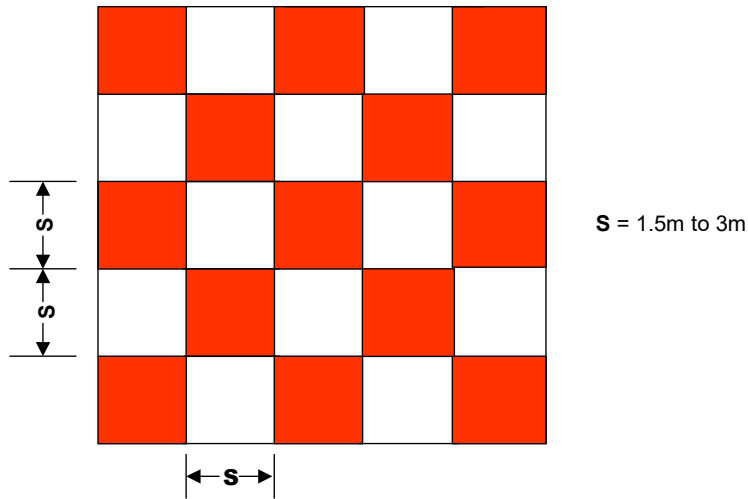
### Division 10 Obstacle markings

#### 8.109 Obstacles and hazardous obstacles

- (1) The following objects or structures at an aerodrome are obstacles and must be marked in accordance with this Division unless CASA determines otherwise under subsections (3) and (5):
  - (a) any fixed object or structure, whether temporary or permanent in nature, extending above the obstacle limitation surfaces;  
*Note* An ILS building is an example of a fixed object.
  - (b) any object or structure on or above the movement area that is removable and is not immediately removed.
- (2) An aerodrome operator must notify CASA in writing of all obstacles at the aerodrome.
- (3) CASA must assess each obstacle notified under subsection (2), and may determine in writing:
  - (a) that an obstacle is a hazard to aircraft (a ***hazardous obstacle***); and
  - (b) what, if any, marking is required for the hazardous obstacle.
- (4) Details of hazardous obstacles, including their lighting and marking requirements, must be included in the aerodrome operator's aerodrome manual, unless CASA has made a determination under subsection (5).
- (5) CASA may determine in writing that a hazardous obstacle may remain unmarked because it is:
  - (a) sufficiently conspicuous in shape, size or colour; or
  - (b) shielded by another obstacle that is already marked; or
  - (c) lit by high-intensity obstacle lights by day and night.
- (6) Despite subsection (1), CASA may determine in writing, following an assessment:
  - (a) that an object or structure on, or within the immediate vicinity of, the aerodrome is a hazardous obstacle; and
  - (b) what, if any, marking is required for that hazardous obstacle.

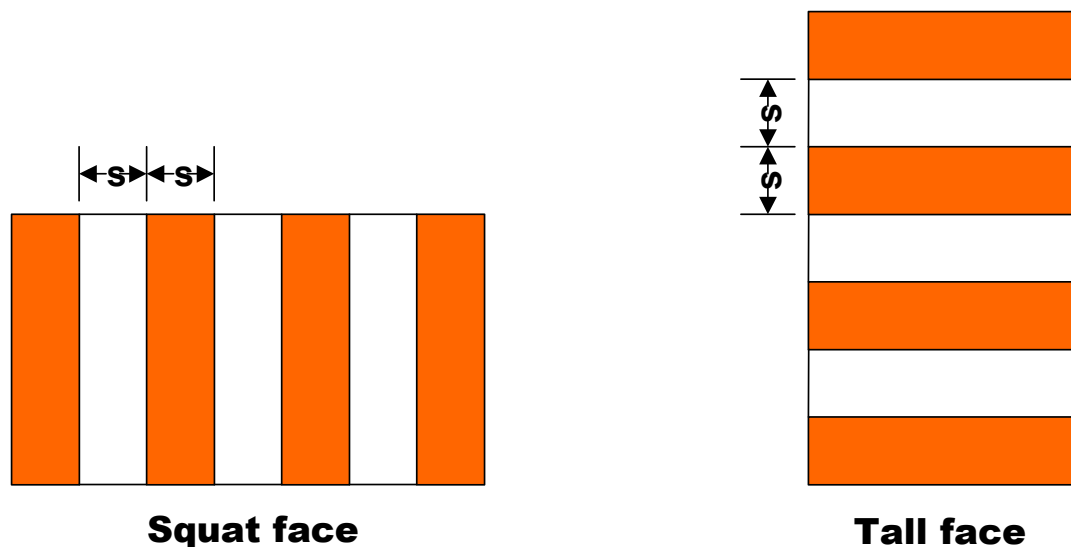
#### 8.110 Marking of hazardous obstacles

- (1) A hazardous obstacle, other than wires and cables, must be marked in a pattern of contrasting colours which also contrast with the background.  
*Note* For example, contrasting colours may be orange and white, or red and white.
- (2) Any hazardous obstacle with unbroken surfaces that are more than 4.5 m by 4.5 m in size, must be marked:
  - (a) in a chequered pattern of lighter and darker squares or rectangles each of whose sides is not less than 1.5 m, and not more than 3 m, long, as shown in Figure 8.110 (2); and
  - (b) so that the corners of the obstacle are in the darker colour.



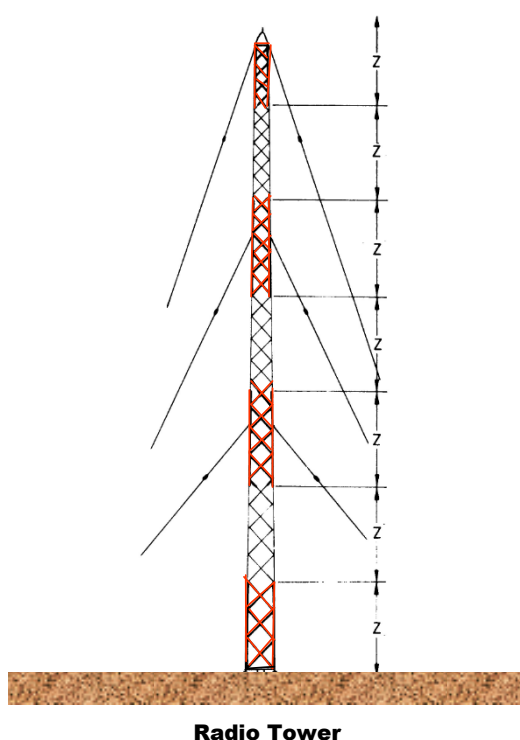
**Figure 8.110 (2) Marking of square face obstacle (shows matters)**

- (3) The following:
- (a) a hazardous obstacle that is more than 1.5 m in 1 direction and less than 4.5 m in the other direction;
  - (b) a hazardous obstacle of a lattice-work construction, for example a crane or a radio tower, that is greater than 1.5 m in both directions;
- must be marked, as shown in Figure 8.110 (3):
- (c) with alternating contrasting bands of colour; and
  - (d) with the ends in the darker colour; and
  - (e) with the bands:
    - (i) at right angles to the longest dimension; and
    - (ii) having a width, shown as “S” in Figure 8.110 (3), that is, approximately, the lesser of:
      - (A) 1/7 of the longest dimension; or
      - (B) 30 m.



**Figure 8.110 (3) Marking of squat or tall face objects or structures (shows matters)**

- (4) A hazardous obstacle (other than a mast, pole or tower) with any dimension less than 1.5 m must be marked in a solid colour that contrasts with the surrounding environment.
- (5) As illustrated in Figure 8.110 (5), long, narrow structures like masts, poles and towers which are hazardous obstacles must be marked in contrasting colour bands so that:
  - (a) the darker colour is at the top; and
  - (b) the bands:
    - (i) are, as far as physically possible, marked at right angles along the length of the long, narrow structure; and
    - (ii) have a length (“z” in Figure 8.110 (5)) that is, approximately, the lesser of:
      - (A) 1/7 of the height of the structure; or
      - (B) 30 m.



**Figure 8.110 (5) Marking of mast, pole and tower (illustrates matters)**

- (6) Fence posts, determined by CASA to be hazardous obstacles, must be marked in a single conspicuous colour that contrasts with the surrounding environment.
 

*Note* CASA recommends that the colour be white.
- (7) Hazardous obstacles in the form of wires or cables must be marked using 3-dimensional coloured objects attached to the wire or cables.
 

*Note* Spheres and pyramids are examples of 3-dimensional objects.
- (8) The objects mentioned in subsection (7) must:
  - (a) be approximately equivalent in size to a cube with 600 mm sides; and
  - (b) be spaced 30 m apart along the length of the wire or cable.

### 8.111 Marking of hazardous transient obstacles

- (1) This section applies if CASA determines in writing, following an assessment, that a transient object is a hazardous obstacle.
- (2) The transient hazardous obstacle must be:
  - (a) marked in the same way as a hazardous obstacle under section 8.110 (a *section 8.110 marking*); or
  - (b) if a section 8.110 marking is not possible — marked with visual aids that:
    - (i) delineate the shape and size of the obstacle; or
    - (ii) make the hazardous obstacle clearly visible to aircraft using the aerodrome.



## CHAPTER 8

### Division 11 Frangibility of markers and signs

#### 8.112 Markers

- (1) To meet the frangibility requirements of this MOS, the materials used in markers must:
  - (a) have a low modulus of toughness; and
  - (b) be sufficiently strong and lightweight for the purpose of the marker.

*Note* In general terms, **toughness** is defined as the capacity of a material to resist fracture under dynamic loads. The modulus of toughness is the ultimate amount of energy by volume that a material will absorb and is determined by measuring the area under the material's stress-strain diagram when plotted to failure. Minimum weight is important to ensure that the least amount of energy is expended to accelerate the mass to the velocity of an impacting aircraft. Further information is available in ICAO Document 9157, Aerodrome Design Manual, Chapter 6 – Frangibility. For ICAO documents, see section 1.07.

- (2) Frangible materials must withstand, or be protected from, outdoor environmental effects, including weathering, solar radiation and temperature fluctuation.
- (3) If weights or fixtures are used to hold markers in place, the weights or fixtures must:
  - (a) themselves be frangible; and
  - (b) not compromise the frangibility of the marker.

#### 8.113 Movement area guidance signs

*Note* Movement area guidance signs include (a) mandatory instruction signs, such as runway designation signs, CAT I, II and III holding position signs, runway holding position signs, road-holding position signs and no entry signs; and (b) information signs, such as direction signs, location signs, runway exit signs, runway vacated signs and intersection take-off signs.

- (1) Movement area guidance signs (**MAGS**) must be:
  - (a) frangible; and
  - (b) constructed of lightweight materials.

*Note* CASA recommends that MAGS should be designed for installation on a concrete pad or on stakes. All required mountings or support hardware should be regarded as part of the sign for frangibility purposes.

- (2) The overall width of a MAGS, including its mounting, must not exceed 3 m.

*Note* If the total message does not fit on a 3 m sign, CASA recommends that 2 separate signs mounted side-by-side should be provided.
- (3) Each mounting leg or stake for a MAGS must have a frangible point located not more than 50 mm above the ground on which the MAGS is located.
- (4) Each frangible point mentioned in subsection (3) must:
  - (a) be capable of withstanding the wind loading delivered by the maximum jet blasts of the aircraft for which the aerodrome is designed; and

- (b) be such that the mounting leg or stake will break or fall over at the frangible point before an applied static load reaches 8.96 kPa.

*Note* ICAO states that for a specified wind loading of 322 km/h (174 kt), breaking should occur before the applied static load reaches a value of 8.96 kPa.

- (5) Legend panels and panel supports on a MAGS must be able to withstand at least the loadings mentioned in subsection (4) and not create a hazard to aircraft if struck.

## CHAPTER 8

### Division 12 Helicopter areas on aerodromes

#### 8.114 Introduction

If an aerodrome is used by both helicopters and fixed-wing aircraft, facilities provided for the exclusive use of helicopters must have specific markings in accordance with this Division.

#### 8.115 Helicopter touchdown and lift-off area markings — non-runway type FATO area

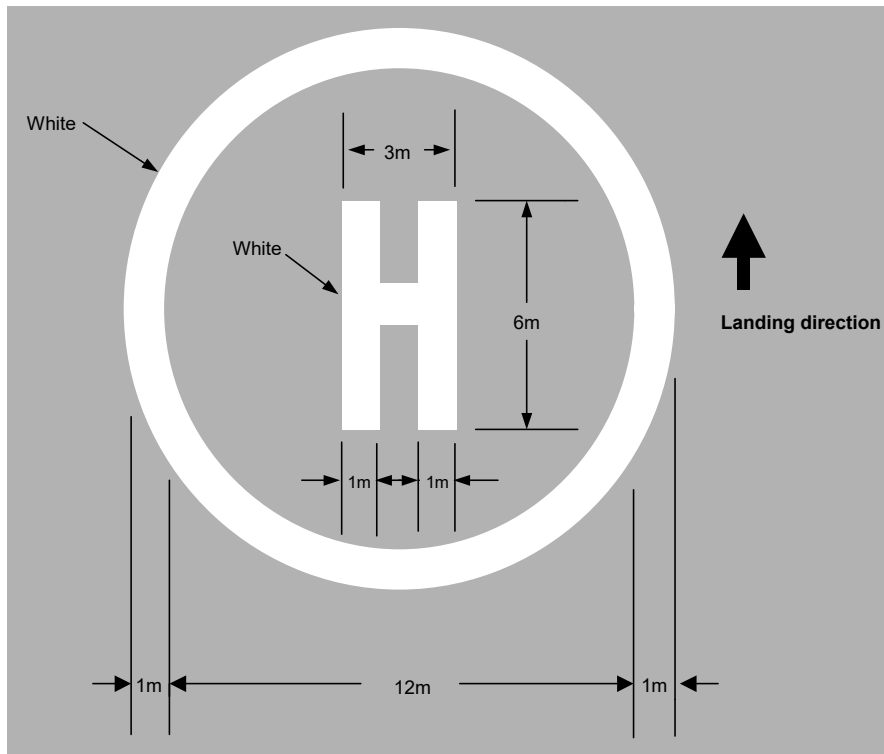
- (1) If a specific area, other than a runway or runway type final approach and take-off (*FATO*) area, is provided for helicopter touchdown and lift-off, the area must be marked by the following:

- (a) a touchdown and lift-off area marking;
- (b) an identification marking;

as shown in Figure 8.115 (1).

*Note* If a runway is used by both fixed-wing aircraft and rotorcraft, the runway does not require dedicated helicopter markings.

- (2) The touchdown and lift-off area must be marked as a white circle with:
  - (a) a line thickness of at least 0.3 m and not more than 1 m; and
  - (b) a minimum inside radius of whichever of the following is the greater:
    - (i) 6 m;
    - (ii) 0.83 times the D value of the largest helicopter using the area.
- (3) The touchdown and lift-off area must have a white “H” identification marking that is:
  - (a) located centrally within the touchdown and lift-off area circle; and
  - (b) aligned with the orientation of the primary helicopter landing direction; and
  - (c) either:
    - (i) 3 m high and 1.8 m wide, with a line thickness of 0.4 m; or
    - (ii) 6 m high and 3 m wide, with a line thickness of 1 m; or
    - (iii) of dimensions within the range constituted by subparagraphs (i) and (ii), provided the proportions are preserved as far as possible.



**Figure 8.115 (1) Helicopter touchdown and lift-off area marking based on touchdown and lift-off area with a 6 m radius and the largest sized identification marking — non-runway type FATO area (shows matters)**

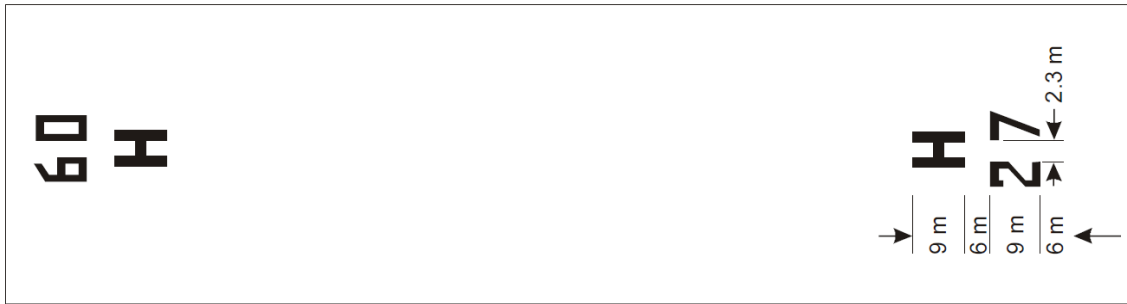
### 8.116 Helicopter touchdown and lift-off area markings — runway type FATO area

*Note* A runway type FATO area is described in ICAO Annex 14, Aerodromes, Volume II, Heliports. In Annex 14, the relevant markings are referred to as *Helicopter FATO designation markings and heliport identification markings for a runway type FATO*. For ICAO documents see section 1.07.

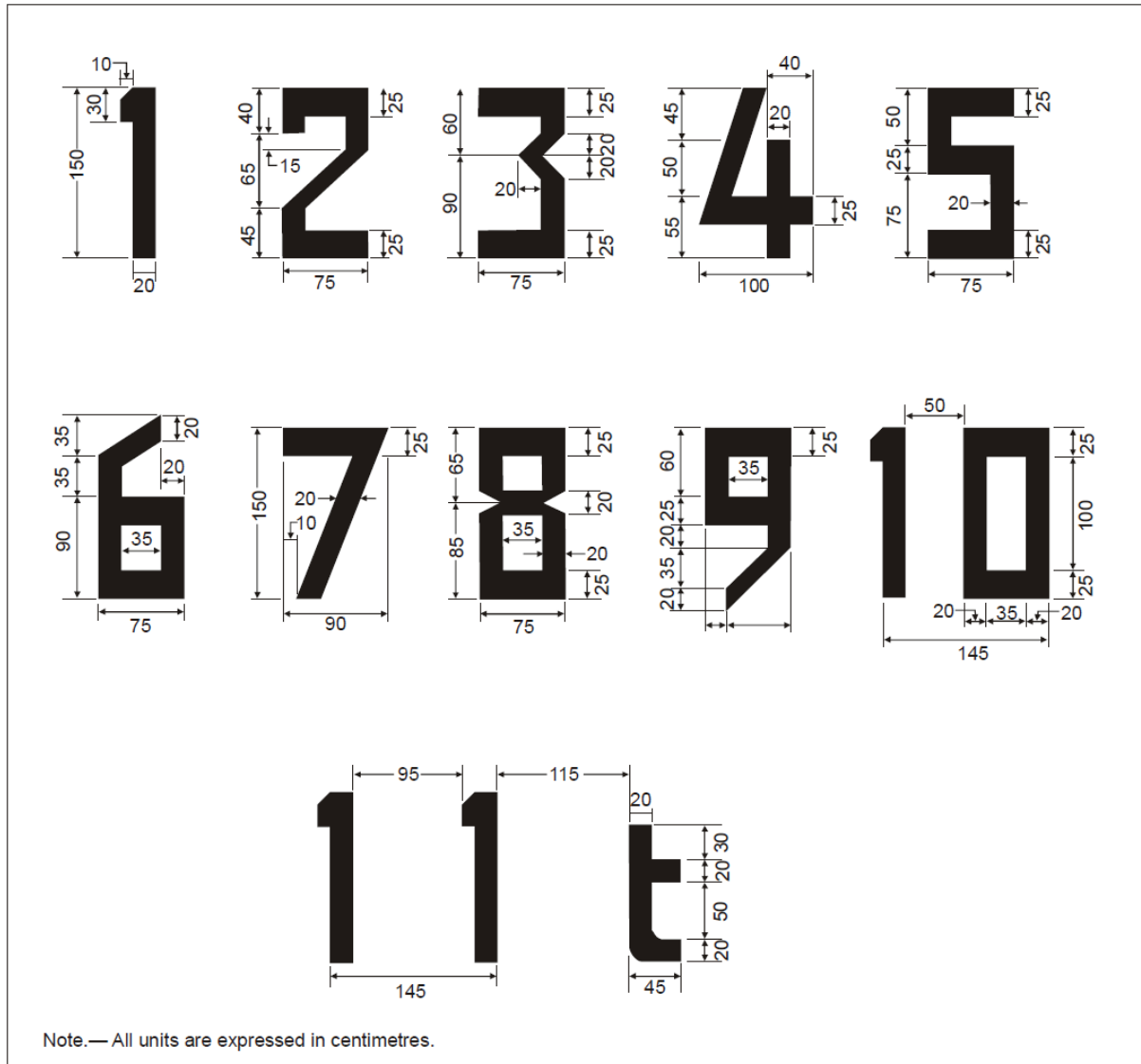
- (1) If a runway type FATO area is provided for the touchdown and lift-off of helicopters on a sealed, asphalt or concrete surface, it must be marked with an identification marking.
- (2) The identification marking must consist of a runway type FATO area designation marking, as shown in Figure 8.116 (2), that is:
  - (a) a white “H” marking, 9 m high and 5.4 m wide, with a line thickness of 1.2 m; and
  - (b) located 6 m from the commencement of the runway type FATO area; and
  - (c) in the form of a 2-digit number that is:
    - (i) derived from the magnetic bearing of the runway type FATO area when viewed from the direction of approach; and
    - (ii) rounded to the nearest 10 degrees.
- (3) If a magnetic bearing becomes a single-digit number, a “0” must be placed before it.
- (4) If a magnetic bearing becomes a 3-digit number, the last “0” digit must be omitted.
 

*Note* For example, a bearing of 353 degrees would be rounded to 350, and the 0 omitted.
- (5) For this section:
  - (a) the letter H in the marking must be in accordance with paragraphs (2) (a) and (b); and

- (b) the numbers in the marking must be:
  - (i) the same height as the letter H; and
  - (ii) the same line thickness as the letter H; and
  - (iii) as far as physically possible, drawn to reflect, in form and width, the same proportions as shown for the numbers in Figure 8.116 (5).
- (6) If a runway type FATO area is provided for the touchdown and lift-off of helicopters in both directions, the identification marking must be provided for both directions as shown in Figure 8.116 (2).



**Figure 8.116 (2) Helicopter FATO designation marking and heliport identification marking for a runway type FATO (shows matters)**



**Figure 8.116 (5) Form and proportions of numbers and letters for helicopter landing and lift-off area marking — runway type FATO area (shows matters)**

### 8.117 FATO area perimeter markings — non-runway type

- (1) If a non-runway type FATO area is provided, the perimeter of the FATO area must:
  - (a) be defined with markings or markers on the edge of the FATO area; and
  - (b) if the FATO area is square or rectangular — have corners defined with markings or markers.
- (2) On a sealed, asphalt or concrete surface, the non-runway type FATO area perimeter marking must be a rectangular, white stripe:
  - (a) that has a line thickness of 1 m; and
  - (b) whose length is whichever of the following is greater:
    - (i) 9 m;
    - (ii) 1/5 of the side of the FATO area which it defines.

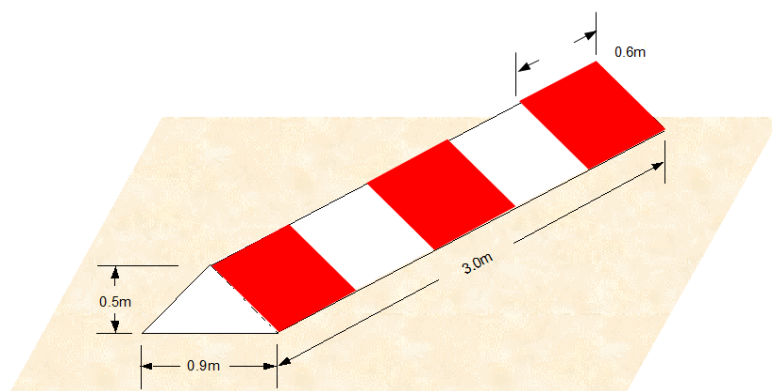
- (3) On a natural surface, non-runway type FATO area perimeter markers must consist of flush in-ground markers that:
  - (a) are 30 cm in width and 1.5 m in length; and
  - (b) have end-to-end spacing between the markers of not less than 1.5 m and not more than 2 m.

### 8.118 FATO area perimeter markings — runway type

*Note* A runway type FATO area is described in ICAO Annex 14, Aerodromes, Volume II, Heliports. For ICAO documents, see section 1.07.

- (1) If a runway type FATO area is provided, the perimeter of the FATO area must be defined with either markings or markers on the edge of the area.
- (2) Runway type FATO area markings and markers must be spaced at equal intervals of not more than 50 m with at least 3 markings or markers located on each side, including a marking or marker at each corner.
- (3) On a sealed, concrete or asphalt surface, a runway FATO area perimeter marking must be a rectangular white stripe:
  - (a) that has a line thickness of 1 m; and
  - (b) whose length is whichever of the following is greater:
    - (i) 9 m;
    - (ii) 1/5 of the side of the FATO area which it defines.
- (4) On a natural surface, runway type FATO area perimeter markers must consist of gable markers that are:
  - (a) 3 m long, 0.9 m wide, and 0.5 m high; and
  - (b) alternating white and red in transverse bands of colour with a width of 0.6 m each, as shown in Figure 8.118 (4).

*Note* For example, “dirt” would be a natural surface.



**Figure 8.118 (4) Runway type FATO marker for a natural surface (shows matters)**

### 8.119 Helicopter taxiway markings

*Note* If a taxiway is used by both fixed-wing and rotorcraft, it does not require dedicated helicopter markings.

- (1) On a sealed, asphalt or concrete surface, dedicated helicopter taxiway markings must be the same as the taxiway markings for fixed-wing aircraft.

*Note* For the taxiway markings for fixed-wing aircraft, see Chapter 8, Division 4.

- (2) On a natural surface, dedicated helicopter taxiway markings must be blue taxiway edge markers that are otherwise the same as for fixed-wing aircraft.

*Note 1* For the taxiway edge markers for fixed-wing aircraft, see Chapter 8, Division 4.

*Note 2* For example, “dirt” would be a natural surface.

### 8.120 Helicopter apron markings

Helicopter apron markings on a sealed, concrete or asphalt surface must be in 1 of the following forms:

- (a) taxi guidelines;
- (b) parking position designation markings;
- (c) helicopter parking position markings.

### 8.121 Helicopter taxi guideline designations

- (1) Helicopter taxi guideline designations must be provided if a taxi guideline leads to a parking position that is restricted to helicopters only.
- (2) Markings for helicopter taxi guidelines must be the same as the markings for fixed-wing aircraft taxi guidelines.

*Note* For fixed-wing aircraft taxi guidelines, see Chapter 8, Division 4.

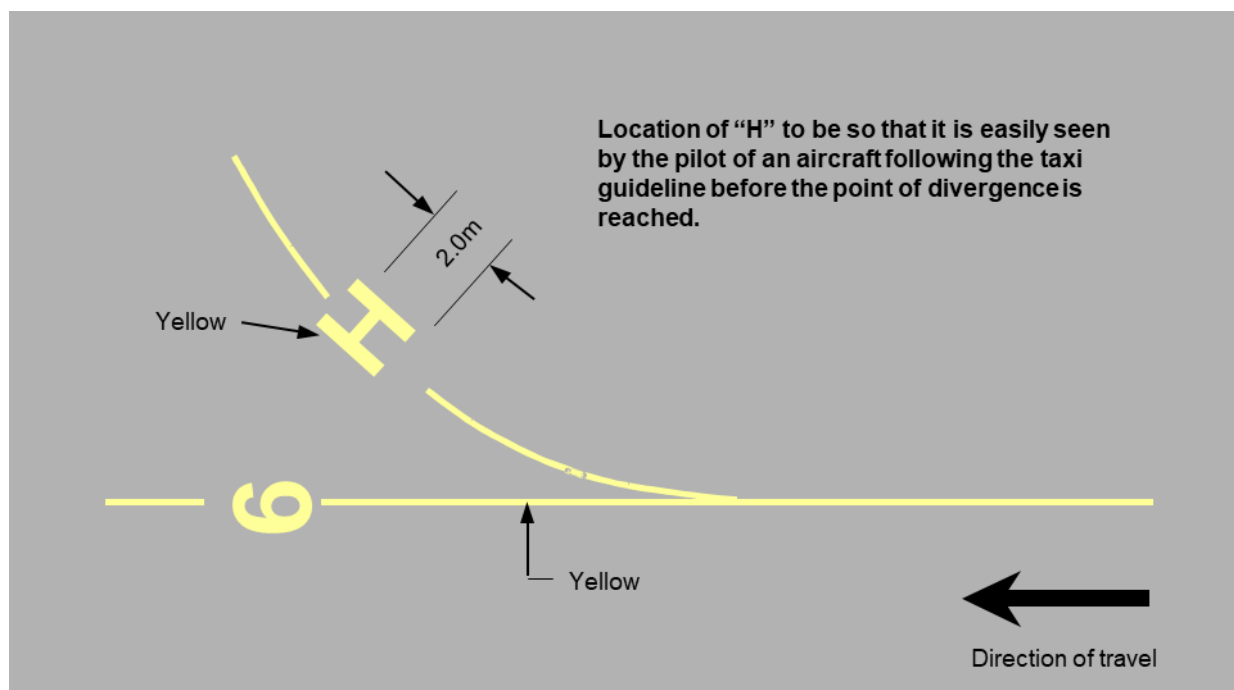
- (3) If an apron contains both fixed-wing aircraft and dedicated helicopter parking positions, taxi guideline designations leading to dedicated helicopter parking positions must be marked with the prefix designator “H”, at their divergence from the aircraft taxi guideline, as shown in Figure 8.121 (3).
- (4) For subsection (3), the prefix designator “H” must be 2 m high and yellow, with a line thickness of 0.3 m.
- (5) When more than 1 helicopter parking position is provided on an aerodrome, each helicopter parking position number must be provided with:
  - (a) the prefix “H”; and
  - (b) a number in sequence with the numbers for any other parking positions.

*Note* In Figure 8.121 (3), only a single helicopter parking position is provided in conjunction with the final aircraft parking position designator. In this case, only the prefix would be required. If more than 1 helicopter parking position or another aircraft parking position is provided on the aerodrome, then the helicopter taxi guideline designation would be designated in this example as H7. This is because “7” is the next parking position in the sequence. Subsequent helicopter parking positions would then need to be marked H8, H9 and so on. Any subsequent aircraft parking positions would need to be numbered sequentially using the same number sequence but without using the “H” prefix.

- (6) If a taxi guideline leads to multiple parking positions, the first and the last parking position in the range may be marked and separated with a dash, for example, H7 – H9.



- (7) Helicopter taxi guideline designations must be located and oriented so that they can be seen 15 m away by an aircraft or helicopter on the taxi guideline.



**Figure 8.121 (3) Helicopter taxi guideline designator to a single helicopter parking position (prefix only) (shows matters)**

### 8.122 Helicopter parking position designation markings

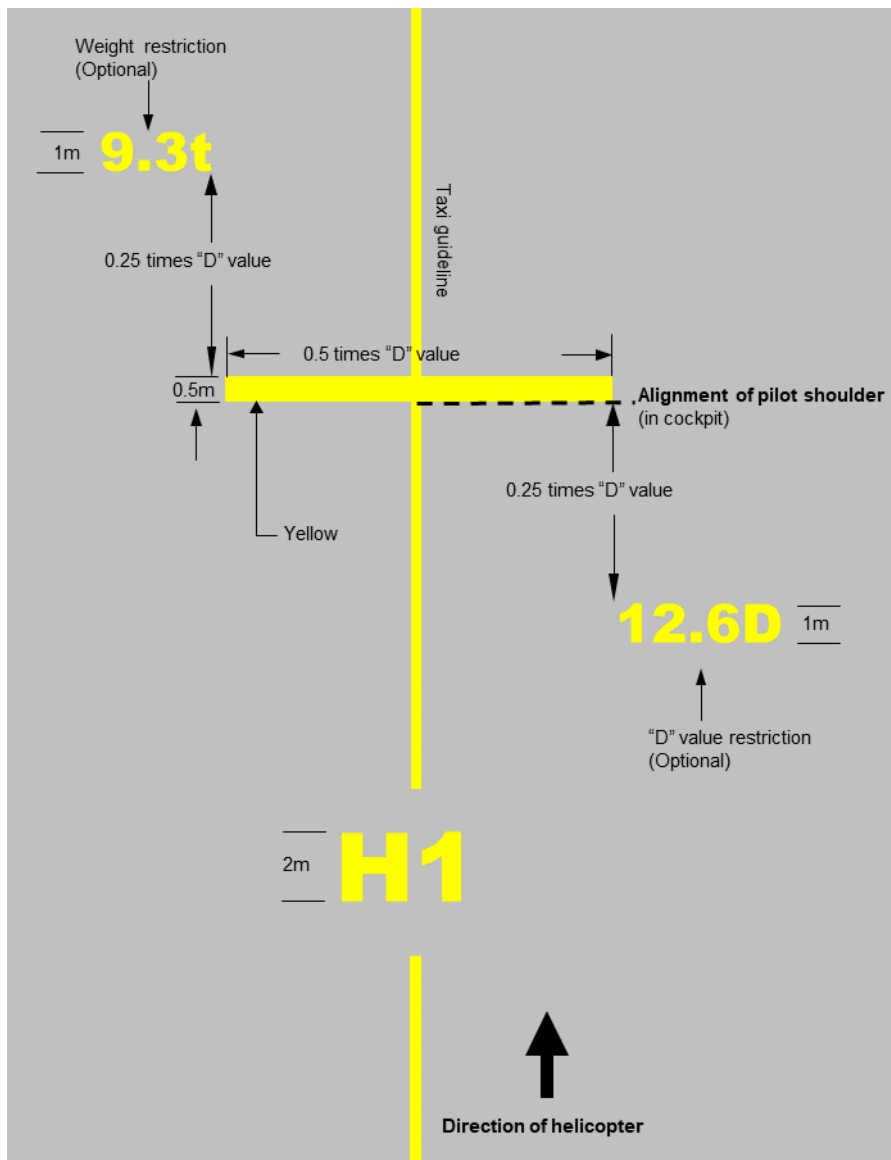
- (1) If a dedicated helicopter parking position is provided on a sealed, concrete or asphalt apron, the parking position must be designated.
- (2) The parking position designator must be marked with the prefix letter "H", yellow and 2 m in height with a line thickness of 0.3 m.
- (3) If more than 1 helicopter parking position is provided, the prefix must include the parking position number in sequence with aircraft parking positions and helicopter taxi guidelines.
- (4) The parking position designator must be located before the helicopter parking position marking, at a distance of 0.83 times the D value of the design helicopter for which the aerodrome is designed (the *design helicopter*), facing the approaching helicopter.

### 8.123 Helicopter parking position markings — shoulder-line type

- (1) If a helicopter parking position requires no turn by the helicopter to enter and leave the parking position, then a shoulder-line type helicopter parking position marking must be provided.
- (2) As shown in Figure 8.123 (2), a shoulder-line type helicopter parking position marking must be:
  - (a) a transverse yellow bar, marked at right angles to, and bisected by, the taxi guideline; and

- (b) 0.5 m wide; and
  - (c) of a length that is 0.5 times the D value of the design helicopter.
- (3) The transverse bar must be aligned with the position of the pilot's shoulder when the design helicopter is correctly parked on the position.
- (4) If it is necessary to restrict the size capacity of the helicopter parking position, a D value limit designator must also be marked:
- (a) at a distance of 0.25 times the D value of the design helicopter before the shoulder bar marking on the side of the approaching helicopter; and
  - (b) with the left-hand edge of the required text aligned with the right-hand side of the shoulder bar; and
  - (c) with the designator letters and numbers:
    - (i) marked 1 m high in yellow; and
    - (ii) as far as physically possible, drawn to reflect, in form and width, the same proportions as shown for the letters and numbers in Figure 8.116 (5); and
    - (iii) clearly readable by the pilot of an approaching helicopter.
- (5) If it is necessary to restrict the weight capacity of the helicopter parking position, a weight limit designator must also be marked:
- (a) at a distance of 0.25 times the D value of the design helicopter after the shoulder bar marking on the opposite side to the approaching helicopter; and
  - (b) with the right-hand edge of the required text aligned with the left-hand side of the shoulder bar; and
  - (c) with the designator letters and numbers:
    - (i) marked 1 m high in yellow; and
    - (ii) as far as physically possible, drawn to reflect, in form and width, the same proportions as shown for the letters and numbers in Figure 8.116 (5); and
    - (iii) clearly readable by the pilot of an approaching helicopter.

*Note* If the helicopter parking position can also be accessed from the reciprocal direction, the shoulder-line type parking position can be marked as bi-directional by using 2 shoulder lines — 1 for each approach direction. If a bi-directional parking position is marked, CASA recommends that care should be taken to ensure any associated D value limit or weight limit markings for each shoulder line do not overlap with the markings for the reciprocal direction.

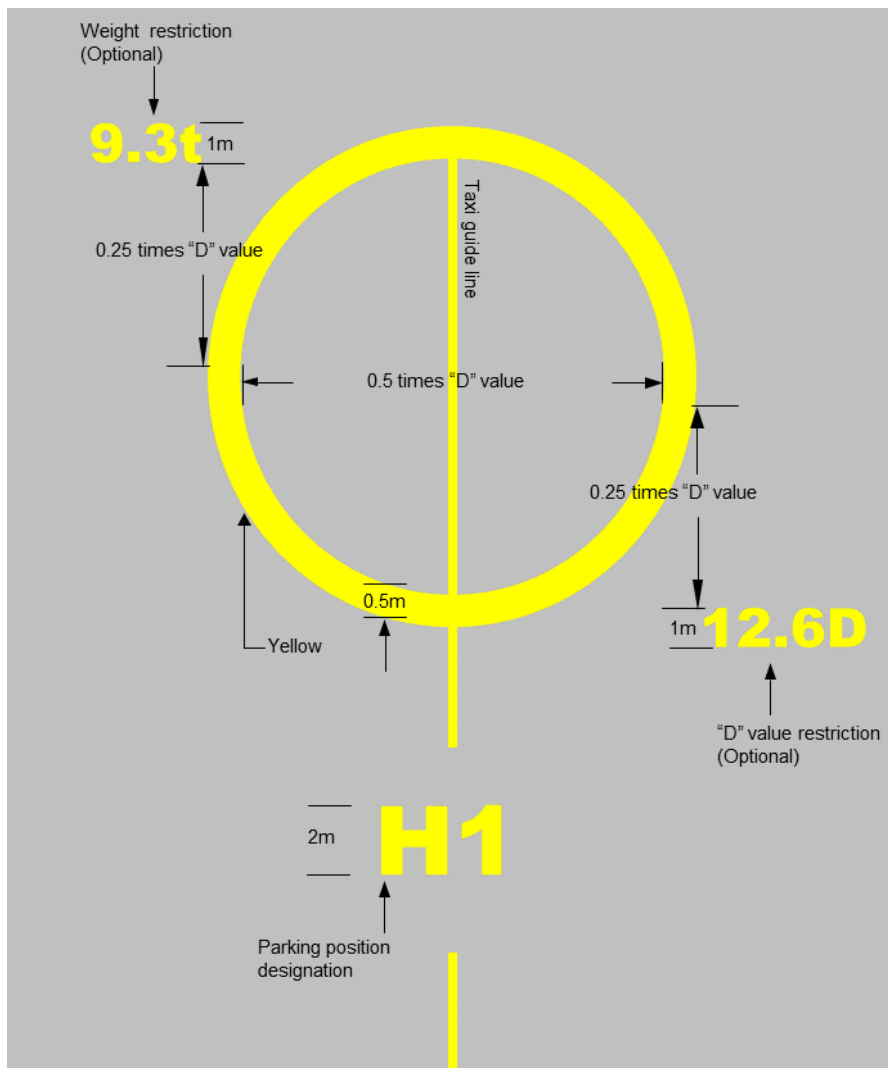


**Figure 8.123 (2) Shoulder-line type helicopter parking position marking (shows matters)**

### 8.124 Helicopter parking position markings — touchdown/positioning circle type

- (1) If a helicopter parking position requires a turn by the helicopter to enter and leave the parking position, then a touchdown/positioning circle (*T/PC*) type helicopter parking position marking is required.
- (2) A *T/PC* type helicopter parking position must be marked by a circle, as shown in Figure 8.124 (2):
  - (a) with a diameter of 0.5 times the *D* value of the design helicopter; and
  - (b) with a line thickness of 0.5 m; and
  - (c) whose centre is aligned with the centroid of the design helicopter when it is correctly parked on the position.

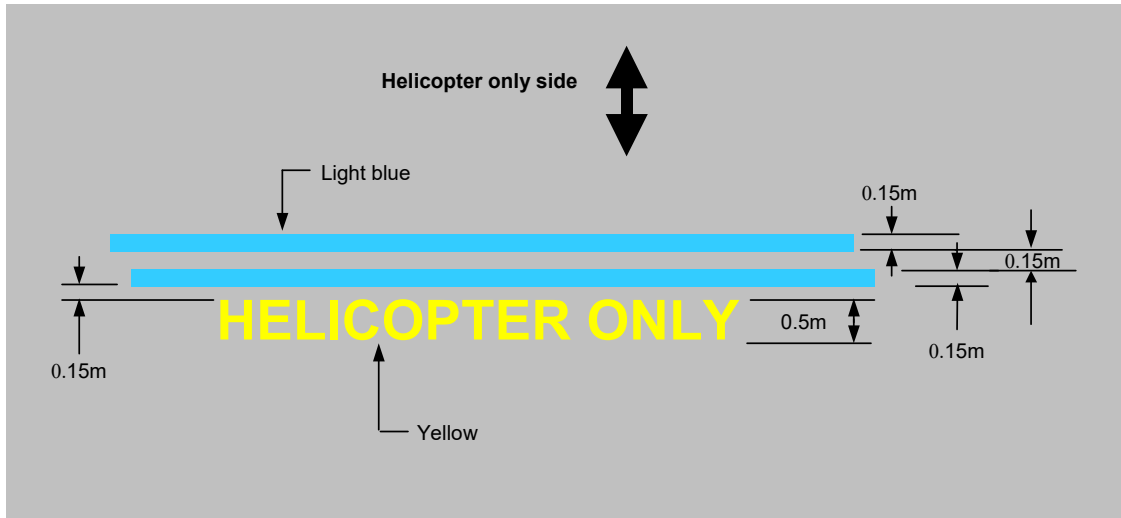
- (3) If it is necessary to restrict the size of the T/PC helicopter parking position, a D value limit designator must also be marked:
  - (a) at a distance of 0.25 times the D value of the design helicopter before the T/PC marking on the side of the approaching helicopter; and
  - (b) with the left-hand edge of the required text aligned with the right-hand side of the T/PC; and
  - (c) with the designator letters and numbers:
    - (i) marked 1 m high in yellow; and
    - (ii) as far as physically possible, drawn to reflect, in form and width, the same proportions as shown for the letters and numbers in Figure 8.116 (5); and
    - (iii) clearly readable by the pilot of an approaching helicopter.
- (4) If it is necessary to restrict the weight capacity of the T/PC helicopter parking position, a weight limit designator must also be marked:
  - (a) at a distance of 0.25 times the D value of the design helicopter after the centroid of the T/PC circle marking on the opposite side of the approaching helicopter; and
  - (b) with the right-hand edge of the required text aligned with the left-hand side of the T/PC; and
  - (c) with the designator letters and numbers:
    - (i) marked 1 m high in yellow; and
    - (ii) as far as physically possible, drawn to reflect, in form and width, the same proportions as shown for the letters and numbers in Figure 8.116 (5); and
    - (iii) clearly readable by the pilot of an approaching helicopter.



**Figure 8.124 (2) Touchdown/positioning circle type helicopter parking position marking (shows matters)**

### 8.125 Helicopter apron edge markings

- (1) Apron edge markings must be provided if it is necessary to clearly define areas allocated specifically for helicopter parking.
- (2) As shown in Figure 8.125 (2), on sealed, concrete or asphalt aprons, the edge marking must:
  - (a) consist of 2 continuous, light blue lines 0.15 m wide and 0.15 m apart; and
  - (b) include the words “HELICOPTER ONLY”:
    - (i) marked in yellow letters 0.5 m high along the edge of the marking, and 0.15 m outside the helicopter apron; and
    - (ii) legible to pilots of approaching aircraft; and
    - (iii) repeated at intervals not exceeding 50 m along the helicopter apron edge marking.



**Figure 8.125 (2) Helicopter apron edge marking (shows matters)**

- (3) On gravel or natural surfaces, the apron must be marked using blue cones, spaced at a minimum distance of 30 m and a maximum distance of 60 m.

*Note* For example, “dirt” would be a natural surface.

- (4) For subsection (3), the cones must be the same size as apron edge cones for fixed-wing aircraft.

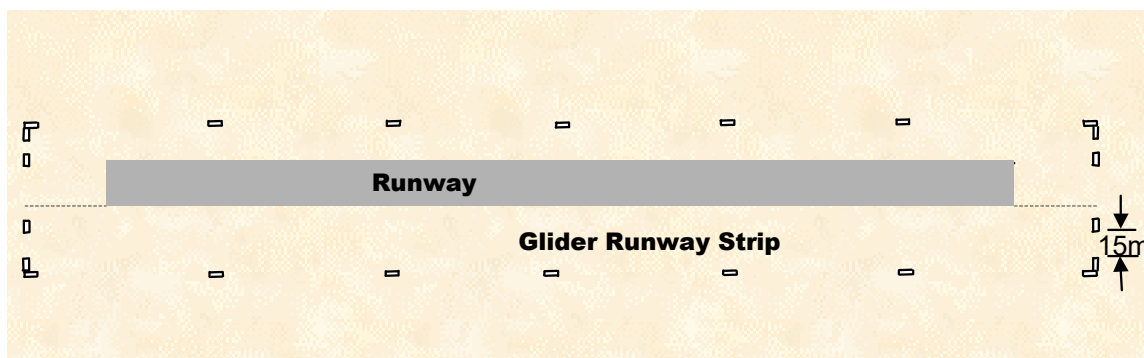
*Note* For apron edge cones for fixed-wing aircraft, see Chapter 8, Division 5.

## CHAPTER 8

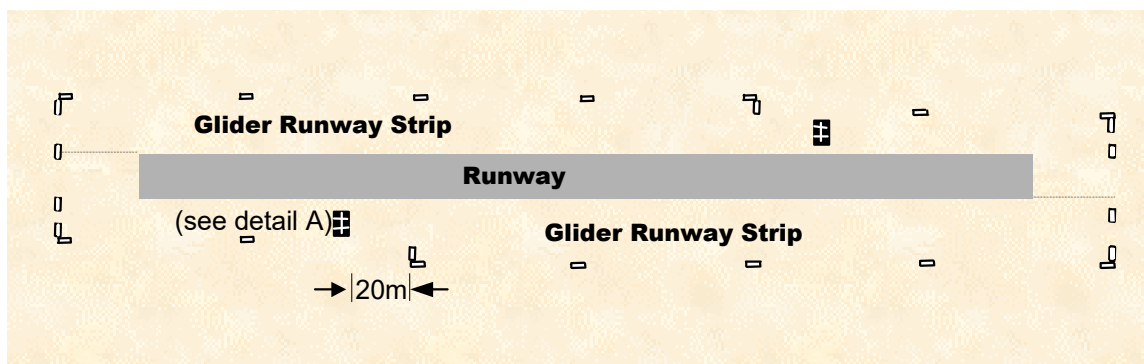
### Division 13 Marking of glider runway strips on an aerodrome

#### 8.126 General

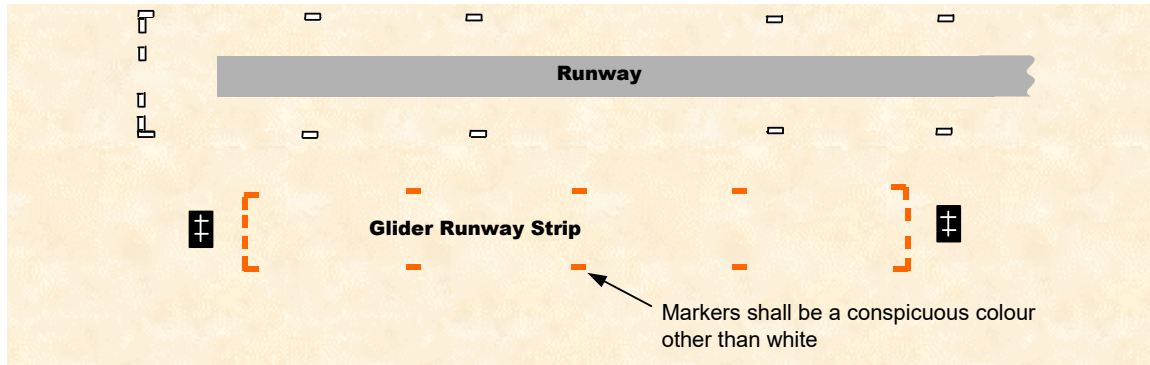
- (1) If a glider runway strip is located wholly or partly within an existing runway strip for powered aircraft, the width of the glider runway strip must be fixed:
  - (a) on 1 side by the edge of the runway for powered aircraft; and
  - (b) on the other side, by the existing runway strip markers, adjusted as necessary, as shown in Figures 8.126 (1)-1 and 8.126 (1)-2.
- (2) If a glider runway strip is located outside an existing runway strip for powered aircraft, the glider runway strip must be marked with boundary markers of a conspicuous colour other than white, as shown in Figure 8.126 (2).
- (3) If an end of a glider runway strip is not alongside the end of an existing runway strip for powered aircraft, an additional white double cross on a black background must:
  - (a) be displayed 20 m in front of the glider strip end markers; and
  - (b) have the dimensions shown in Figure 8.126 (3); and
  - (c) be located as illustrated in Figures 8.126 (1)-2 and 8.126 (2).



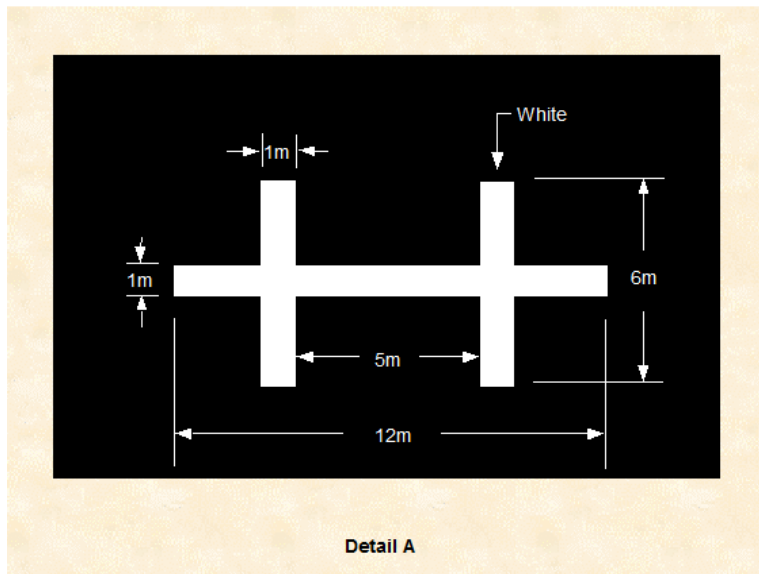
**Figure 8.126 (1)-1** Glider runway strip taking up the full length of a powered aircraft runway strip (no additional signal required) (shows matters)



**Figure 8.126 (1)-2** Glider runway strip taking up part of the powered aircraft runway strip — see Figure 8.126 (3) for detail A (shows matters)



**Figure 8.126 (2) Glider runway strip outside an existing powered aircraft runway strip (shows matters)**



**Figure 8.126 (3) Detail of glider operations signal as referenced in Figures 8.126 (1)-2 and 8.126 (2) (shows matters)**



## CHAPTER 9 VISUAL AIDS PROVIDED BY AERODROME LIGHTING

### Division 1 Lighting requirements

#### 9.01 Minimum lighting system requirements

- (1) If an aerodrome is available for night operations, lighting systems must be provided for:
  - (a) all runways, taxiways and aprons intended for night use; and
  - (b) at least 1 wind direction indicator; and
  - (c) if an obstacle within the applicable obstacle limitation surface (OLS) area of the aerodrome is determined by CASA as requiring obstacle lighting — that obstacle; and
  - (d) all unserviceable areas.
- (2) Despite paragraph (1) (a), if appropriate lighting is provided to at least 1 code A or code B taxiway, a retroreflective marker may be used instead of lighting on the other code A or code B taxiways that are not provided with lighting.
- (3) A visual approach slope indicator system (VASIS), in accordance with section 9.44, must be provided to serve the approach to a runway if:
  - (a) the runway is used at least once a week in air transport operations by non-propeller driven turbine-engine aeroplanes; or
  - (b) CASA, in the interests of aviation safety, directs in writing that a runway be provided with a VASIS.
- (4) An approach lighting system must be provided for a runway intended to serve CAT II or CAT III precision approach operations. However, the system may be truncated, if CASA agrees in writing with an aerodrome operator that it is physically impossible to comply with Divisions 6, 7 and 8 of this Chapter.

*Note* An approach lighting system is required for a runway intended to serve CAT I operations with a visibility of less than 1 500 m. See section 9.41.

- (5) An approach lighting system, other than one referred to in subsection (4), is not required, or may be truncated, if CASA agrees in writing with an aerodrome operator that it is physically impossible to comply with Divisions 6, 7 and 8 of this Chapter.

*Note* However, note that the omission or truncation of an approach lighting system could result in an increase to the landing minima, which could adversely affect the efficiency, or the regularity, of operations, or both the efficiency and regularity. See Chapter 9, Division 6.

- (6) Movement area guidance signs (MAGS) must be illuminated in accordance with the standards set out in section 8.85.

#### 9.02 Electrical circuitry

- (1) Electrical equipment and wiring (other than a light or a light fitting):
  - (a) subject to subsection 15.05 (6), must not be installed above ground level on a manoeuvring area; and
  - (b) must be kept clear of aircraft on an apron.

*Note* Above ground wiring for temporary lighting may be permissible when certain works are being carried out — see subsection 15.05 (6).

- (2) For a runway intended for operations in runway visibility, or RVR, of less than 550 m, aerodrome ground lighting, including lighting for the runway, taxiway, approach, visual approach slope indicator, and aerodrome MAGS lighting circuits, must be designed so that a lighting equipment failure does not leave the pilot of an aircraft using the manoeuvring area with inadequate visual guidance or misleading information.

*Note* Interleaf circuitry is recommended for aerodromes intended for precision approach operations. Guidance on this may be found in ICAO Document 9157, Aerodrome Design Manual – Part 5, Electrical. For ICAO documents, see section 1.07.

### 9.03 Primary electrical power supply

An aerodrome lighting system must have a primary electrical power supply (*primary power supply*) which ensures the continued and full operation of the system in accordance with this MOS.

### 9.04 Secondary electrical power supply

- (1) A secondary electrical power supply (*secondary power supply*) must enable continued and complete operation of each of the following lighting systems (if installed) in the event of a failure of the primary power supply:

- (a) approach;
- (b) visual approach slope indicator;
- (c) runway edge;
- (d) runway threshold;
- (e) runway end;
- (f) runway centreline;
- (g) touchdown zone;
- (h) taxiway;
- (i) runway guard lights;
- (j) no entry bars and stop bars;
- (k) apron;
- (l) illuminated wind direction indicators;
- (m) mandatory movement area guidance signs (if provided);
- (n) other movement area guidance signs essential for the safety of air navigation;
- (o) such aerodrome obstacle lighting as is determined by CASA, in writing, to be essential for the safety of aircraft operations.

*Note 1* Paragraph 9.04 (1) (o) is not applicable to off-aerodrome obstacle lighting.

*Note 2* CASA recommends that a secondary electrical power supply be provided for aids that are essential for the safety of air navigation, for example automatic weather information broadcasts and automatic aerodrome frequency response units.

- (2) If an aerodrome has 1 or more runways intended for precision approach CAT I operations, the lighting for at least 1 of the CAT I runways must have a secondary power supply.

- (3) If an aerodrome has 1 or more runways intended for precision approach CAT II or CAT III operations, the lighting for at least 1 of the CAT II or CAT III runways (the *relevant runway*) must have a secondary power supply.
- (4) Each runway from which aircraft are intended to take off in RVR conditions less than 800 m must have a secondary power supply to enable the operation of each of the following lighting systems (if installed):
  - (a) runway edge;
  - (b) runway end;
  - (c) runway centreline;
  - (d) stop bars;
  - (e) runway guard lights, when stop bars are not being used;
  - (f) essential taxiway lights, including no entry bars;
 

*Note* CASA considers taxiway routes for operations in conditions less than 800 m to be essential.
  - (g) essential obstacle lights.

*Note* For essential obstacle lights, see paragraph 9.04 (1) (o).

### 9.05 Switch-over time for secondary power supply

- (1) The time interval between failure of the primary power supply and the complete restoration of power following switch-over to a secondary power supply must not exceed:
  - (a) for precision approach CAT I visual aids — 15 seconds;
  - (b) for precision approach CAT II and CAT III visual aids that are:
    - (i) essential obstacle lights — 15 seconds; and
    - (ii) essential taxiway lights — 15 seconds; and
    - (iii) all other visual aids — 1 second;
  - (c) for runways meant for take-off in RVR conditions less than 800 m:
    - (i) for essential obstacle lights — 15 seconds; and
    - (ii) for essential taxiway lights including no entry bars — 15 seconds; and
    - (iii) for runway edge lights, if runway centreline lights are provided — 15 seconds; and
    - (iv) for runway edge lights, if runway centreline lights are not provided — 1 second; and
    - (v) for runway end lights — 1 second; and
    - (vi) for runway centreline lights — 1 second; and
    - (vii) for all stop bars — 1 second.

*Note* For subsection 9.05 (1), alerting of the generators is an acceptable method of achieving the required switch-over times.
- (2) If alerting the generators is the method used to switch over to secondary power within the time frames specified in subsection (1), then the method must:
  - (a) ensure that each generator is started and can meet the required power demand:
    - (i) before commencement of low visibility; or

- (ii) as soon as weather conditions indicate that electrical power from the primary power supply may reasonably be susceptible to interruption; and
  - (b) if the primary power supply fails — ensure that the electrical system automatically reconnects the load to the secondary power supply.
- (3) If alerting of the generators is the method used to switch over to secondary power within the timeframes specified in subsection (1) for:
- (a) CAT II or CAT III precision approaches; or
  - (b) take-offs in RVR conditions less than 800 m;
- then the aerodrome operator must supply real-time information to ATC on the operating status of:
- (c) each generator set; and
  - (d) the primary power supply.

### 9.06 Stand-by power supply

*Note* There is an operational benefit in a runway lighting system being notified in the AIP-ERSA as having stand-by power or portable lighting available. Stand-by power is normally for non-instrument or non-precision runway lighting systems.

- (1) The AIP-ERSA must record whether an aerodrome lighting system has a stand-by power supply and, if so, whether the stand-by power supply is:
  - (a) automatic; or
  - (b) manually-activated.
- (2) If the stand-by power is manually-activated:
  - (a) the aerodrome manual must contain procedures to ensure that the power is activated by a responsible person:
    - (i) as soon as possible after the need for activation arises; and
    - (ii) as far as possible, never later than 15 minutes after the need arises; and
  - (b) the aerodrome operator must ensure that the expected activation time is notified in the AIP-ERSA.

*Note* Stand-by power is distinct from secondary power.

### 9.07 Portable runway lights

- (1) Portable runway lights may only be used to support:
  - (a) a visual operation where the permanent lighting system is temporarily unserviceable; or
  - (b) a temporary emergency where a permanent lighting system is not required to be installed.

*Note* For example, portable lights may be used at an aerodrome for landings and take-offs as follows:

- (a) if the aerodrome is intended for regular night operations and, therefore, has a permanent lighting system installed — to replace unserviceable lights until the permanent lights are urgently repaired;
- (b) if the aerodrome is not intended for regular night operations and, therefore, does not have a permanent lighting system installed — for temporary emergencies such as medical emergencies or emergency landings.

- (2) Portable runway lights must:
  - (a) where practicable, have an omnidirectional light output; and
  - (b) be visible from a distance of not less than 3 NM despite any weather conditions likely to be prevailing at the expected time of their use; and
  - (c) subject to paragraph (d), be of the same colour as the permanent lights; and
  - (d) if the provision of coloured lights at the threshold and the runway end is not possible, all portable runway lights may be variable white or as close to variable white as possible; and
  - (e) be spaced in the same way as the permanent lights; and
  - (f) be level so that the vertical axis is true; and
  - (g) be deployed in such a way that an aircraft guided by the lights can land into the wind.
- (3) If an aerodrome is notified in the AIP-ERSA as having portable runway lights, the following requirements apply:
  - (a) the portable runway lights must always be:
    - (i) serviceable; and
    - (ii) ready to operate;
  - (b) appropriate persons must be trained to do the following as soon as possible when the need arises:
    - (i) deploy the portable runway lights;
    - (ii) put them into operation.

*Note* An appropriate person must respond as soon as possible. However, a pilot must take into account the possibility that some travel time may be required before the appropriate person can respond to the aerodrome. A pilot who may be planning to an aerodrome without standby power or who has to hold for emergency lighting to be placed or activated at the aerodrome, should either plan an alternate, carry additional holding fuel or not plan for that aerodrome.

- (4) The AIP-ERSA entry must include a notation that prior notice of operations is required.
- (5) For an aircraft arrival, the portable lights must be lit or switched on (**activated**) at least 30 minutes before the estimated time of arrival.
- (6) For an aircraft departure, the portable lights must:
  - (a) be activated at least 10 minutes before the scheduled time of departure; and
  - (b) remain activated after take-off:
    - (i) for at least 30 minutes; or
    - (ii) if no air-ground communication exists with the aircraft — for at least 1 hour.

*Note 1* Retention of the portable lights is required for the contingency that an aircraft may need to return to the aerodrome.

*Note 2* Portable runway lights are distinct from secondary power.

## 9.08 Portable lights on taxiways and apron edges

- (1) If a lighting outage, including from aerodrome works or aerodrome maintenance, requires the temporary removal from service of the permanent taxiway lights or apron edge lights,

portable taxiway edge lights may be used as a temporary replacement for the duration of the outage.

- (2) If used, the portable taxiway edge lights must:
  - (a) be steady blue lights; and
  - (b) when located on a taxiway — be placed on each side of the taxiway aligned with the installed centreline lights or co-located with the taxiway edge lighting, except where the taxiway intersects another taxiway or runway in which case the lights may be placed on only one side of the taxiway edge; and
  - (c) when located on an apron edge — be co-located with the installed apron edge lighting; and
  - (d) as far as possible, have the same photometric characteristics as permanently installed taxiway lighting intended for operations with visibility greater than 350 m; and

*Note* See also section 9.93.

  - (e) if used with a section of taxiway centreline lights which are out of service — overlap with the serviceable taxiway centreline lights for 2 light spacings within each end of the unserviceable area (to ensure a graduated transition).

## 9.09 Light fixtures and supporting structures

- (1) All aerodrome light fixtures and, subject to subsection (2), supporting structures must be:
  - (a) independently certified (that is by a person independent from the manufacturer) for frangibility in accordance with the standards on frangibility under:
    - (i) ICAO Document 9157, Aerodrome Design Manual Part 4 – Visual Aids, Chapter 15, Frangibility of Visual Aids; and
    - (ii) ICAO Document 9157, Aerodrome Design Manual Part 6 – Frangibility; and
  - (b) of the minimum weight that is consistent with the fixture or structure being fit for its function.

*Note* For ICAO documents, see section 1.07.
- (2) In the portion of the approach lighting system that is more than 300 m from the runway threshold:
  - (a) if the height of the structure exceeds 12 m — the frangibility requirement mentioned in subsection (1) applies only to the top 12 m of the supporting structure; and
  - (b) if the supporting structure is surrounded by non-frangible objects — only that part of the structure that extends above the surrounding objects must be frangible.
- (3) If an approach lighting fixture, or its supporting structure, is not in itself clearly conspicuous to the pilot of an approaching aircraft, it must be marked in accordance with Chapter 8, Division 10.

## 9.10 Standardisation of aerodrome lighting

- (1) Lights with different design types must not be mixed in a lighting system unless their photometric characteristics:
  - (a) are matched as closely as possible; and
  - (b) are not visually distracting or confusing to pilots; and

- (c) otherwise meet the requirements of this MOS.
- (2) Solid state lights and incandescent lights must not be mixed:
  - (a) within any individual lighting system on a runway, including the following:
    - (i) threshold lighting;
    - (ii) edge lighting;
    - (iii) centreline lighting;
    - (iv) end lighting;
    - (v) approach lighting;
    - (vi) touchdown zone lighting;
    - (vii) visual approach slope indicator system lighting; or
  - (b) in the lighting within a taxiway section.

### 9.11 Elevated and inset lights

- (1) Elevated lights must:
  - (a) be frangible; and
  - (b) have yellow casings; and
    - Note* See subsection 8.03 (2) for the standard colour for “yellow”.
  - (c) on taxiways — be sited clear of aircraft propellers and jet engine pods for the aircraft code letter for which the taxiway is designed; and
  - (d) not extend more than 360 mm above ground level; and
  - (e) not be used when inset lights must be used in accordance with this MOS.

*Note* Elevated lights are not recommended on pavements which aircraft or vehicles travel over, or in movement areas subject to significant jet blast.

- (2) Despite paragraph (1) (d), Configuration A runway guard lights may extend up to 500 mm above ground level.

*Note* Configuration A runway guard lights are described in section 9.99.

- (3) If an inset light is not installed within a pavement, the inset light must be protected from vegetation growth for a minimum radius of 1 m around the light by being installed:

- (a) on a sealed surface; or
- (b) on a surface with a protective cover; or
- (c) on a surface that is treated, and maintained, in accordance with procedures in the aerodrome manual.

- (4) Inset lights must:

- (a) ensure that runway and taxiway sight distance requirements are met; and

*Note* See sections 6.07 and 6.42.

- (b) not have any sharp edges; and
- (c) where the lights will not normally come into contact with aircraft wheels — not project more than 25 mm above or below the surrounding surface at each light’s location; and

*Note* For example, threshold lights, runway end lights and runway edge lights.

- (d) not project more than 13 mm above the surrounding surface at any location which will normally come into contact with aircraft wheels.

*Note* For example, runway centreline lights, touchdown zone lights and taxiway centreline lights.

- (5) The design of an inset light fixture must be such that the surface temperature of the light does not exceed 160°C when it is:
  - (a) operating at its maximum intensity; and
  - (b) covered by the wheel of a ground vehicle or aircraft continuously for 10 minutes.
- (6) The design of an inset light fixture must be such that it will not distort or otherwise fail when subjected to the wheel loads of the intended aircraft over its expected operational life.

*Note* Refer to FAA *Advisory Circular 150/5345-46*, as in force or existing from time to time, and freely available from the FAA website, [www.faa.gov](http://www.faa.gov), for an acceptable means of compliance.

- (7) Maintenance must be conducted to ensure that surface contaminants on or around an elevated light or an inset light fitting do not obscure or cover the light beam.

## 9.12 Lighting intensity and control

- (1) Lighting intensity must be controlled so that, in conditions of minimum visibility, a pilot is not subjected to a light output that may have an adverse effect on aviation safety (a ***hazardous light output***).
- (2) Data on the operating current and the corresponding intensity selection must be documented in the aerodrome manual.
- (3) At an aerodrome with an ATS provider, each of the following lighting systems, if provided, must be equipped with an intensity control so that the ATS provider can select light output to suit ambient conditions and avoid dazzling pilots:
  - (a) approach lighting system;
  - (b) visual approach slope indicator system (VASIS);
  - (c) runway edge, threshold and end lights;
  - (d) runway centreline lights;
  - (e) runway touchdown zone lights;
  - (f) taxiway lights;
  - (g) stop bars and no entry bars;
  - (h) apron centreline and apron edge lights.
- (4) Subject to subsection (3), aerodrome lighting intensity for medium-intensity lighting systems, if provided, may be controlled by any of the following:
  - (a) a certified air/ground radio operator (CA/GRO);
  - (b) a UNICOM operator;
  - (c) a responsible person with 2-way radio communications with aircraft;
  - (d) an aircraft using an aerodrome system that can be remotely controlled by the pilot.



- (5) The following high-intensity lighting systems or lights must be capable of at least 5 intensity stages:
  - (a) approach lighting systems;
  - (b) VASIS;
  - (c) high-intensity runway edge;
  - (d) runway threshold and end lights;
  - (e) runway centreline lights;
  - (f) runway touchdown zone lights.
- (6) At least 2 intensity stages must be provided for taxiway lights used in RVR conditions less than 800 m.
- (7) All aerodrome lighting intensity control, where required in accordance with this Chapter, must be reducible from maximum to minimum intensity, through successive reductions of between 25% to 35% in each intensity stage.

*Note* Each stage of light intensity, from minimum to maximum, should nominally achieve about a 3:1 increase in light output at each stage of higher intensity.

- (8) At an aerodrome where:
  - (a) the lighting is provided with variable intensity settings but the ATS provider, CA/GRO, UNICOM operator or responsible person does not provide 24 hour coverage; and
  - (b) either:
    - (i) the operator leaves the lights turned on all night; or
    - (ii) the lights are controlled by a PAL out of hours;

the default light intensity must be such as is clearly visible to pilots.

- (9) If a lighting system is operated by an ATS provider or a person mentioned in subsection (4) (the **lighting system operator**), an automatic monitoring system must:
  - (a) generate the following information:
    - (i) that a lighting system is, or is not, switched on;
    - (ii) the intensity of each lighting system that is switched on;
    - (iii) any fault in a lighting system used to control aircraft movement; and
  - (b) relay the information to the lighting system operator:
    - (i) for a stop bar at a runway holding position — within 2 seconds of generating the information mentioned in paragraph (a); and
    - (ii) for all other types of visual aid — within 5 seconds of generating the information mentioned in paragraph (a).

*Note* CASA recommends that a runway meant for use in runway visibility, or RVR, less than 550 m should have a suitable monitoring system for informing ATC and the operator's maintenance crew when the serviceability level of any of the following lighting systems falls below the minimum level for the system:

- (a) approach lighting;
- (b) runway centreline;
- (c) runway threshold;
- (d) runway edge;

- (e) touchdown zone;
- (f) runway end;
- (g) stop bars and no entry bars;
- (h) essential taxiways.

### 9.13 Colours for aeronautical ground lights

- (1) Light fittings using different filter technologies must not be mixed in a way that creates inconsistency in light colour or intensity when the light is viewed by the pilot of an aircraft moving on a runway or taxiway.

*Note* Different filter technologies include dichroic filters, other absorption filters, and light emitting diodes (**LEDs**).

- (2) The colour of aeronautical ground lights must be verified by the manufacturer or supplier as being within the boundaries specified in Figures 9.14 and 9.15, by measurement at 5 points within the area limited by the innermost isocandela curve with operation at rated current or voltage.
- (3) For elliptical or circular isocandela curves, the colour measurements must be taken at the centre and at the horizontal and vertical limits.
- (4) For rectangular isocandela curves, the colour measurements must be taken at the centre and the limits of the diagonals (that is, the corners).
- (5) The colour of aeronautical ground lights must be checked at the outermost isocandela curve to ensure that there is no colour shift that might cause signal confusion to a pilot.
- (6) In the case of a VASI or other light unit having a colour transition sector, the colour must be measured at points in accordance with subsections (3) and (4), except that:
  - (a) the colour areas must be treated separately; and
  - (b) no point may be within 0.5 degrees of the transition sector.

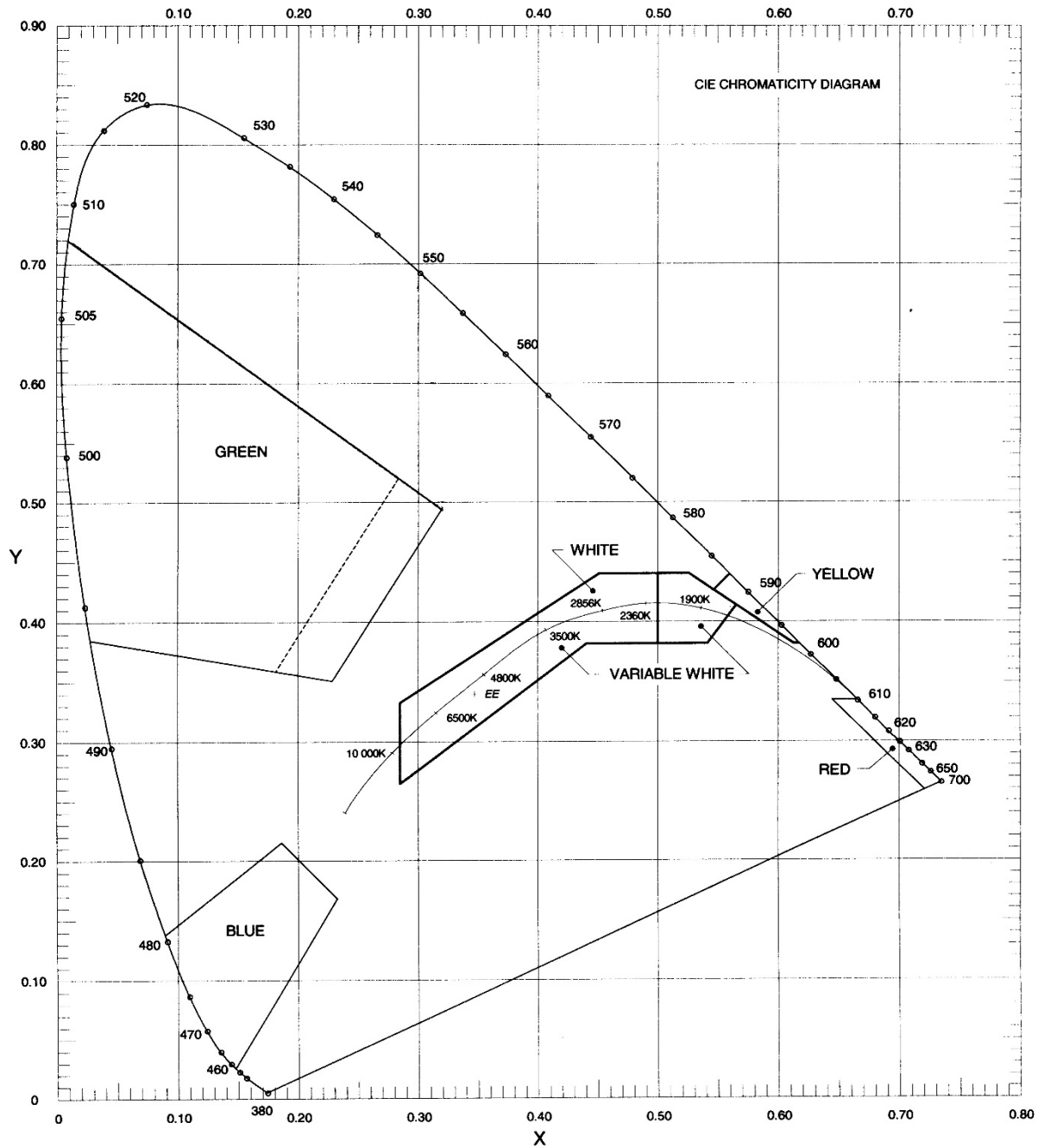
### 9.14 Chromaticity for incandescent lights

Aerodrome incandescent lighting must comply with the chromaticity boundaries as shown in Table 9.14 and Figure 9.14.

*Note* The chromaticities are expressed in terms of the standard observer and coordinate system adopted by the International Commission on Illumination (**CIE**).

**Table 9.14 Chromaticity for incandescent lights**

Red	Purple boundary	$y = 0.980 - x$
	Yellow boundary (visual approach light indicator systems only)	$y = 0.320$
	Yellow boundary (all other lights)	$y = 0.335$
Yellow	Red boundary	$y = 0.382$
	White boundary	$y = 0.790 - 0.667x$
	Green boundary	$y = x - 0.120$
Green	Yellow boundary	$y = 0.726 - 0.726x$
	White boundary (except for visual docking guidance systems)	$x = 0.650y$
	White boundary (for visual docking guidance systems)	$x = 0.625y - 0.041$
	Blue boundary	$y = 0.390 - 0.171x$
Blue	Green boundary	$y = 0.805x + 0.065$
	White boundary	$y = 0.400 - x$
	Purple boundary	$x = 0.600y + 0.133$
White	Yellow boundary	$x = 0.500$
	Blue boundary	$x = 0.285$
	Green boundary	$y = 0.440$ and $y = 0.150 + 0.640x$
	Purple boundary	$y = 0.050 + 0.750x$ and $y = 0.382$
Variable White	Yellow boundary	$x = 0.255 + 0.750y$ and $x = 1.185 - 1.500y$
	Blue boundary	$x = 0.285$
	Green boundary	$y = 0.440$ and $y = 0.150 + 0.640x$
	Purple boundary	$y = 0.050 + 0.750x$ and $y = 0.382$



**Figure 9.14 Colours for incandescent aeronautical ground lights**

**9.15 Chromaticity for solid state (LED) lights**

- (1) Subject to subsection (2), the chromaticity of aeronautical ground lights with solid state (LED) light sources must be within the boundaries as shown in Table 9.15 and Figure 9.15.

**Table 9.15 Chromaticity for solid state (LED) lights**

Red	Purple boundary	$y = 0.980 - x$
	Yellow boundary (for VASI)	$y = 0.320$
	Yellow boundary (other than VASI)	$y = 0.335$
Yellow	Red boundary	$y = 0.387$
	White boundary	$y = 0.980 - x$
	Green boundary	$y = 0.727x + 0.054$
Green	Including:	
	Yellow boundary	$x = 0.310$
	White boundary	$x = 0.625y - 0.041$
	Blue boundary	$y = 0.400$
White (including variable white)	Yellow boundary	$x = 0.440$
	Blue boundary	$x = 0.320$
	Green boundary	$y = 0.150 + 0.643x$
	Purple boundary	$y = 0.050 + 0.757x$
Blue	Green boundary	$y = 1.141x - 0.037$
	White boundary	$y = 0.400 - x$
	Purple boundary	$x = 0.134 + 0.590y$

- (2) For the colour green, signals within a lighting system must be within one but not both of the following sets of boundaries:

(a) either these:

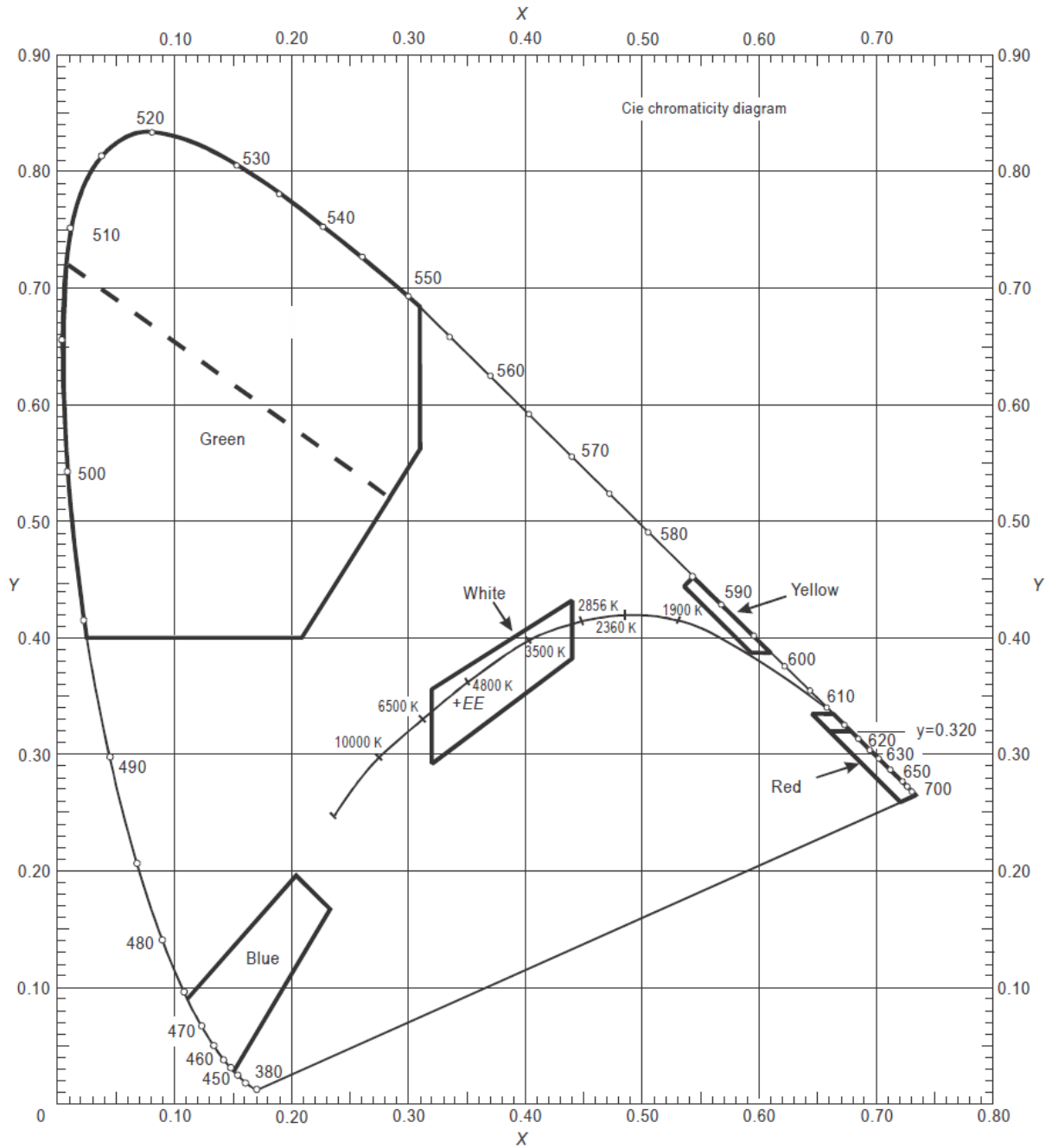
Yellow boundary	$y = 0.726 - 0.726x$
White boundary	$x = 0.625y - 0.041$
Blue boundary	$y = 0.400$ ; or

*Note* The presentation of green within this boundary is recommended where observers with defective colour vision are required to determine the green colour of the light signal as opposed to other colours.

(b) these:

Yellow boundary	$x = 0.310$
White boundary	$x = 0.625y - 0.041$
Blue boundary	$y = 0.726 - 0.726x$

*Note* The specifications under paragraphs (a) and (b) must not be used together within the same lighting system.



**Figure 9.15 Colours for solid state (LED) aeronautical ground lights**

## 9.16 Discrimination between incandescent coloured lights

- (1) If there is a requirement to discriminate yellow and white from each other, they must each be displayed in close proximity in time or space, for example, by being flashed successively from the same beacon.
- (2) If there is a requirement to discriminate yellow from green or white, for example, with exit taxiway centreline lights, the value of the “y” coordinate of the yellow light must be less than 0.40.

*Note* The limits of white are based on the assumption that they are used in situations in which the characteristics of the light source, for example, colour and temperature, are substantially constant.

- (3) The colour variable white is intended to be used only for lights that must be varied in intensity to avoid dazzling. If these lights must be distinguished from yellow lights, they must be designed and operated so that:
  - (a) the “x” coordinate of the yellow is at least 0.050 greater than the “x” coordinate of the white; and
  - (b) the disposition of the lights is such that the yellow lights are displayed simultaneously and in close proximity to the white lights.

## CHAPTER 9

### Division 2 Commissioning

#### 9.17 Commissioning of lighting systems — ground checks

- (1) Before an aerodrome lighting system is first used, including after an upgrade or a replacement:
  - (a) the system must be commissioned through:
    - (i) a ground check in accordance with this section; and
    - (ii) a flight check as required in accordance with section 9.18; and
  - (b) written evidence, verifying the commissioning process, must be provided to CASA in the form of:
    - (i) the ground check determination; and
    - (ii) the flight check report.
- (2) A ground check must be conducted by a *qualified person* who:
  - (a) has demonstrable relevant aerodrome lighting knowledge and experience; and
  - (b) is either:
    - (i) an electrical engineer; or
    - (ii) a licensed electrician.
- (3) A ground check of a VASIS must be conducted by a person who:
  - (a) has demonstrable knowledge of how to site, set up and protect a VASIS; and
  - (b) is either:
    - (i) technically qualified or experienced in surveying; or
    - (ii) a civil engineer with survey experience.
- (4) A ground check of a VASIS must include the following:
  - (a) verification of vertical and horizontal angles of light signal changes;
  - (b) a survey of the VASIS at its installed location;
  - (c) a survey of the obstacle assessment surface.
- (5) If satisfied that the lighting system is both of the following:
  - (a) correctly installed;
  - (b) compliant with the standards specified in this MOS for photometrics, frangibility, supply and other relevant characteristics;then the qualified person must make a ground check determination, in writing, that the aerodrome lighting system complies with this MOS for a ground check.
- (6) For a ground check, the aerodrome operator must provide the qualified person with evidence that light fitting types, models and versions comply with the standards for photometric and other relevant characteristics specified in this MOS.



- (7) For subsection (6), the evidence must be in the form of:
  - (a) an independent compliance statement from each of the manufacturers, and the supplier, of the aerodrome lighting system; or
  - (b) a test report from an accredited laboratory.
- (8) For paragraph (7) (a), the compliance statement must be formally endorsed by a **verifying body** that is independent from both the manufacturer and the supplier of the lighting system, and that is either:
  - (a) an aviation safety regulator with which Australia has a bilateral agreement to recognise a compliance statement provided for aerodrome lighting systems; or
  - (b) another person or body approved in writing by CASA to provide a compliance statement for aerodrome lighting systems.
- (9) For subsection (8), the endorsement must be documented and authorised by a responsible person of the verifying body.
- (10) For paragraph (7) (b), evidence in the form of a **test report** from an accredited laboratory must be:
  - (a) from a laboratory that is accredited by the National Association of Testing Authorities (**NATA**); or
  - (b) from an overseas accrediting authority which has a mutual recognition agreement with NATA, under which NATA confirms that the overseas accrediting authority has the competence to carry out the type of measurement involved; or
  - (c) from a laboratory that is accredited and has a mutual recognition arrangement administered by the International Laboratory Accreditation Corporation in accordance with ISO/IEC 17011, as in force or existing from time to time.

*Note* ISO/IEC 17011 is available at <https://www.iso.org/standards.html>. This is the joint International Organization for Standardization/International Electrotechnical Commission standard for the competence, consistent operation and impartiality of accreditation bodies assessing and accrediting conformity assessment bodies.

## 9.18 Commissioning of lighting systems — flight checks

- (1) For subparagraph 9.17 (1) (a) (ii), commissioning of a lighting system must include flight checks by a qualified flight checker, supported by a written flight check report, confirming that the following are in accordance with the requirements of this MOS:
  - (a) the approach lighting system;
  - (b) the runway lighting system for instrument runways;
  - (c) unless CASA approves otherwise, the VASIS;
  - (d) for aerodromes with scheduled air transport operations — the PAL;
  - (e) for aerodromes without scheduled air transport operations — the PAL, at the time a new PAL is installed.
- (2) For paragraph (1) (c), CASA may only approve otherwise if:
  - (a) the VASIS is provided for temporary use only; and
  - (b) the approval is supported by a safety assessment; and
  - (c) the approval is in writing with appropriate conditions (if any).

- (3) For subsection (1), a ***qualified flight checker*** means a person approved in writing by CASA to conduct, and report on, flight checks of aerodrome lighting systems.
- (4) The aerodrome operator must not request a NOTAM, or update their AIP-ERSA information, to reflect a commissioned lighting system, unless and until the operator has obtained:
  - (a) a qualified person's ground check determination that the lighting system complies with this MOS as required under section 9.17; and
  - (b) subject to subsection (2), a qualified flight checker's flight check report in accordance with subsection (1).
- (5) Following receipt of the determination and report mentioned in subsection (4), the aerodrome operator must supply the applicable information mentioned in section 5.05 and paragraph 5.09 (4) (c) to the NOTAM Office and the AIS provider for inclusion in the AIP-ERSA.
- (6) For a lighting system not mentioned in subsection (1), the aerodrome operator must use a ground check report as evidence of compliance with the standards in this MOS to initiate a NOTAM.
- (7) At any time after commissioning of a lighting system, CASA may direct a ground check, a flight check or both such checks, for an aerodrome lighting system referred to in subsection 9.17 (1) or a system mentioned in subsection (1), if:
  - (a) CASA considers that a substantial change has been made to the system since it was commissioned; or
  - (b) CASA receives, from a pilot or an aircraft operator, any adverse report on the performance of the system.

*Note* Changes which CASA may consider would constitute a substantial change include any of the following:

  - (a) removal and replacement, at the same time, of 50% or more of the light fittings, or type of light source within an approach or runway lighting system;
  - (b) removal and replacement of 1 or more light units of a PAPI;
  - (c) removal and replacement, at the same time, of 2 or more light units of an AT-VASIS;
  - (d) replacement of the transceiver installation from a PAL.
- (8) A separate copy of each ground check report, each flight check report, and each independent compliance statement or light fitting laboratory test report used to support the commissioning of a lighting system must be retained by the aerodrome operator for as long as the relevant lighting system remains in service, with details of each report included in the aerodrome operator's aerodrome manual.

## CHAPTER 9

### Division 3 Pilot-activated lighting systems

#### 9.19 General

- (1) A pilot-activated lighting system (a *PAL*) must turn on all the lighting facilities required for aircraft operations at night, unless the lighting facility is turned on by other means.

*Note* An example of other means is a photo-electric switch or timer.

- (2) If a PAL is used to activate a VASIS, the following requirements apply:
  - (a) activation of the PAL during daytime must:
    - (i) turn the VASIS on to the day intensity setting; and
    - (ii) leave all other aerodrome lighting off;
  - (b) activation of the PAL during twilight must:
    - (i) turn the VASIS on to the twilight intensity setting; and
    - (ii) turn all other aerodrome lighting on to:
      - (A) the only other intensity available; or
      - (B) night intensity if multiple intensities are available;
  - (c) activation of the PAL during night-time must:
    - (i) turn the VASIS on to night intensity; and
    - (ii) turn all other aerodrome lighting on to:
      - (A) the only other intensity available; or
      - (B) night intensity if multiple intensities are available;
  - (d) if the lighting has been activated by the PAL — appropriate changes from day to twilight to night intensities must take place automatically;
  - (e) the appropriate changes from day to twilight to night operation must take place under the control of:
    - (i) a light sensitive switch or similar device; or

*Note* For guidance in setting up the light sensitive switch, the following values of background illuminance are suggested, though other values, or an illuminance meter, may be used if they provide a better match to local visibility conditions:
      - (a) day — illuminance above 500 lux;
      - (b) twilight — illuminance between 50 and 500 lux;
      - (c) night — illuminance below 50 lux.
    - (ii) a switching system that will ensure the correct intensity setting between day, twilight and night.
- (3) If, because of local conditions, an aerodrome requires the aerodrome lights to be set at a higher intensity than night intensity, then a twilight intensity setting may be used, provided it does not produce glare hazard to pilots.
- (4) The PAL must activate an aerodrome lighting system if it detects a coded carrier frequency signal from an airband VHF transmitter (a *coded signal*).

- (5) On receipt of the coded signal:
  - (a) the PAL control unit must go into the operate mode for a pre-set period; and
  - (b) the lights must remain on:
    - (i) for a period of at least 30 minutes; or
    - (ii) for a period longer than 30 minutes — if local aerodrome operating conditions require the lights to remain on for a longer period in the interests of aviation safety.
- (6) Ten minutes before the aerodrome lighting system is due to turn off, the PAL must cause the lights of at least the primary illuminated wind direction indicator (*pIWDI*) to flash, and continue to flash, at between 40-50 cycles per minute until either:
  - (a) the PAL switches off, and all aerodrome lighting, including the pIWDI lights, is extinguished; or
  - (b) the PAL has been reset for another “on” period.
- (7) When in operate mode (including the last 10 minutes), the receipt of another transmitted activation code must reset the PAL to the beginning of the pre-set period.

## 9.20 VHF carrier activation code

- (1) The code required to activate the PAL must be generated when the press-to-talk switch of the aircraft VHF transmitter is depressed and a radio frequency carrier signal is produced.
- (2) The activation code must consist of 3 bursts of carrier signal, each between 1 and 5 seconds long, with the last 2 code bursts completed within 24 seconds of the end of the first burst.
- (3) The PAL detector must be capable of tolerating a gap of 0.1 seconds between code bursts.

*Note* This is the minimum time it takes to depress and release the aircraft press-to-talk switch. CASA recommends that the code pilots should send is 3 bursts of approximately 3 seconds each, with at least 1 second between bursts, and the 3 bursts must be transmitted within a total of 25 seconds from first to last.

## 9.21 VHF carrier receiver technical requirements

- (1) The VHF carrier receiver (the *receiver*) must accept a carrier signal over the frequency range of 118 MHz to 136 MHz.
- (2) The receiver must be controlled at a single frequency within the frequency range, with a channel separation of 25 kHz.
- (3) The frequency stability must be within  $\pm 0.0010\%$  over the temperature range of  $-10^{\circ}\text{C}$  to  $+60^{\circ}\text{C}$ .
- (4) The minimum detectable input signal of the carrier detector must:
  - (a) be adjustable over a range to suit operational requirements; and
  - (b) under normal circumstances, be set at a receiver sensitivity of not less than  $15\ \mu\text{V}$  to ensure timely activation of the PAL by aircraft approaching the aerodrome.

*Note 1* The suitability of the receiver sensitivity from different azimuth of the aerodrome will be flight tested by a qualified flight checker (that is, a pilot approved by CASA) during the commissioning of the system.

*Note 2* The upper range of the receiver sensitivity may be of the order of 50 to 65  $\mu\text{V}$ , but may be adjusted downward depending on whether nuisance operation is experienced from aircraft using the same PAL frequency at other locations.

*Note 3* For paragraph (4) (b), the usual activation distance is 15 NM. However, to ensure timely activation, this may vary for expected aircraft types and their approach speeds.

- (5) The VHF carrier detector bandwidth must have the following characteristics:
  - (a) for within 3 dB of nominal —  $\pm 7.5$  kHz;
  - (b) for greater than 60 dB below nominal —  $\pm 16$  kHz;
  - (c) a spurious response of not less than 80 dB below nominal.

## 9.22 Inputs to the PAL

The PAL must be capable of:

- (a) receiving the radio frequency activation signals, as described in this Division; and
  - (b) manual activation through an on/off switch such that:
    - (i) if the switch is selected to on — the lighting system is activated and remains on; and
    - (ii) if the switch is selected to off — the PAL goes into operate mode for the full timing cycle, including the 10 minute turn-off warning; and
- Note* This is intended for use by authorised ground personnel, departing pilots, and maintenance technicians.
- (c) if provided at a controlled aerodrome — being electronically overridden by an air traffic controller on duty.

## 9.23 Fail-safe arrangements with the PAL

- (1) The electronic circuitry of the PAL must be so designed that if the PAL fails then provision of aerodrome lighting will continue because:
  - (a) the lighting facilities will be automatically turned on in the event of the PAL failure; and
  - (b) a bypass switch will allow manual activation of the lights by a responsible person nominated in writing by the aerodrome operator.
- (2) The PAL must be so designed that transient electrical surges have no effect on the PAL.
- (3) When a PAL resumes proper operation following a PAL failure, the following must occur:
  - (a) the PAL must automatically commence and complete a “Light on” cycle;
  - (b) as soon as the power returns and the PAL has energised — the pilot must be notified, via AFRU transmission (if applicable), that the lighting is ON.
- (4) During a power failure for a PAL that is fitted with stand-by power only the pilot must be notified, via AFRU transmission (if applicable), that the PAL has not energised.

## 9.24 Access to manual switches

If manual switches are provided for a PAL, they must be readily accessible to the responsible person at all times.

## 9.25 Receiving antenna

- (1) The receiving antenna for a PAL must be located such that it will receive activating signals from:
  - (a) aircraft in the air; and

- (b) aircraft, ground vehicles, and mobile personnel on the aerodrome movement area.
- (2) The PAL must be so designed that it will operate when connected to an antenna that has the following specifications:
  - (a) unity gain with respect to a dipole;
  - (b) vertical polarisation;
  - (c) omnidirectional radiation pattern in the horizontal plane;
  - (d) voltage standing wave ratio, when matched to the PAL antenna input, of not greater than 1.5:1 over the frequency range of 118 to 136 MHz;
  - (e) a height of the mounting above local ground level of not less than 4.5 m.

## 9.26 PAL with audio acknowledgment

*Note* CASA recommends that aerodrome operators use a PAL with message acknowledgment capability.

- (1) PAL with audio acknowledgment capability must provide:
  - (a) positive response on receipt of pilot transmission; and
  - (b) caution if the lighting cycle is within the 10 minute switch off phase.
- (2) The broadcast message (if any) must:
  - (a) for PAL activation, and for the commencement of the flash cycle — be such as to minimise congestion on the frequency; and
  - (b) for the commencement of the flash cycle — provide the remaining time for activation.

*Note* CASA recommends that a typical broadcast message should be of the form:

Name of aerodrome [INSERT NAME] AERODROME LIGHTING ON.

Name of aerodrome [INSERT NAME] LIGHTS 10 MINUTES REMAINING.

Name of aerodrome [INSERT NAME] AERODROME LIGHTING NOT ACTIVATED.

## CHAPTER 9

### Division 4 Obstacle lighting

#### 9.27 Artificial objects and structures

- (1) Subject to subsection (2), for a runway intended to be used at night, the following artificial objects or structures are hazardous obstacles and must be provided with obstacle lighting:
  - (a) an object or structure that extends above the take-off climb surface within 3 000 m of the inner edge of the take-off climb surface;
  - (b) an object or structure that extends above the approach or transitional surface within 3 000 m of the inner edge of the approach surface;
  - (c) an object or structure that extends above the applicable inner, conical or outer horizontal surfaces;
  - (d) an object or structure that extends above the obstacle assessment surface of a T-VASIS or PAPI;
  - (e) an object or structure in the vicinity of a taxiway, an apron taxiway or a taxilane, that is a hazard to aircraft using the taxiway, apron taxiway or taxilane, except that obstacle lights must not be installed on elevated ground lights or MAGS.
- (2) For paragraph (1) (e):

*in the vicinity of* means in the 5% plane:

  - (a) originating laterally from the edge of the graded section of the taxiway strip or the edge of the graded portion of the runway strip; and
  - (b) whose origin is ground level at the edge of the graded portion of the runway or taxiway strip.
- (3) Despite subsection (1), CASA may determine in writing, following an assessment, that a hazardous obstacle may remain unlit because it is:
  - (a) shielded by another object or structure that is already lit; or
  - (b) does not present a significant hazard to aviation safety.
- (4) Despite subsection (1), CASA may determine in writing, following an assessment:
  - (a) that an object or structure on, or within the immediate vicinity of, the aerodrome is a hazardous obstacle; and
  - (b) what, if any, lighting is required for that hazardous obstacle.

*Note* Owners of tall buildings or structures whose summit is below the obstacle limitation surfaces, or that is less than 100 m above ground level, may, of their own volition, provide obstacle lighting to indicate the presence of such buildings or structures at night. To ensure consistency, avoid confusion to pilots, and further the interests of safety both in the air and on the ground, such obstacle lighting should conform with the standards specified in this MOS.
- (5) Obstacle lighting may be used during the day instead of obstacle marking.
- (6) Obstacle lighting must operate throughout the hours of darkness unless it is within the aerodrome boundary and activated by a PAL.

## 9.28 Natural obstacles

*Note* Natural obstacles such as terrain and vegetation are normally extensive. If they infringe an OLS, the need for obstacle lighting will be assessed by CASA on a case by case basis.

If CASA so directs in writing, obstacle lighting must be provided for natural obstacles that infringe an OLS as follows:

- (a) if the natural obstacle is located within the approach area — the portion of the obstacle within the approach area must be lit in the same manner as artificial objects or structures;
- (b) if the natural obstacle is located outside the approach area — the highest features, and the prominent features, of the natural obstacle must have obstacle lighting.

## 9.29 Temporary artificial obstacles

At night, or in poor visibility conditions, temporary artificial hazardous obstacles in the approach area or on the movement area must be lit:

- (a) with red obstacle lights; and
- (b) so that the lights clearly mark the height, extremities and extent of the obstacle.

## 9.30 Types of obstacle lighting and their use

- (1) The following types of obstacle lights must be used, in accordance with this MOS, to light hazardous obstacles:

- (a) low-intensity;
- (b) medium-intensity;
- (c) high-intensity;
- (d) a combination of low, medium or high-intensity.

- (2) Low-intensity obstacle lights:

- (a) are steady red lights; and
- (b) must be used on non-extensive objects or structures whose height above the surrounding ground is less than 45 m.

- (3) Medium-intensity obstacle lights must be:

- (a) flashing white lights; or
- (b) flashing red lights; or
- (c) steady red lights.

*Note* CASA recommends the use of flashing red medium-intensity obstacle lights.

- (4) Medium-intensity obstacle lights must be used if:

- (a) the object or structure is an extensive one; or
- (b) the top of the object or structure is at least 45 m but not more than 150 m above the surrounding ground; or
- (c) CASA determines in writing that early warning to pilots of the presence of the object or structure is desirable in the interests of aviation safety.

*Note* For example, a group of trees or buildings is regarded as an extensive object.



- (5) For subsection (4), low-intensity and medium-intensity obstacle lights may be used in combination.
- (6) High-intensity obstacle lights:
  - (a) must be used on objects or structures whose height exceeds 150 m; and
  - (b) must be flashing white lights.
- (7) Despite paragraph (6) (b), a medium-intensity flashing red light may be used if necessary to avoid an adverse environmental impact on the local community.

### **9.31 Location of obstacle lights**

- (1) This section applies for any hazardous obstacle that must be provided with obstacle lighting, as illustrated in Figures 9.31 (1)-1, 9.31 (1)-2, 9.31 (1)-3 and 9.31 (1)-4.

*Note* For objects or structures that must be provided with obstacle lighting, see sections 9.27, 9.28 and 9.29.

- (2) Obstacle lights must be located:
  - (a) as close as possible to the top of the object or structure; and
  - (b) in such numbers, and in such arrangements, as to ensure that the lights clearly indicate at least the points or edges of the object or structure that are highest above the obstacle limitation surface.
- (3) Subject to subsection (4), for the following objects or structures:
  - (a) a structure to the top of which an appurtenance is attached, for example, a lightning rod, flag, antenna, or aerial;
  - (b) a structure from at or near the top of which a contaminating substance is emitted, for example, smoke, gas or fumes;

the top lights must be placed as close to the top of the structure as is consistent with minimising the likelihood of visual obstruction from:

- (c) the attachment; or
- (d) the emissions.

*Note* Normally, the lights should be located 1.5 m to 3 m from the top of the structure.

- (4) If an appurtenance, for example, a lightning rod, flag, antenna, or aerial, on a tower-like structure (including an antenna):
  - (a) extends more than 12 m above the structure; and
  - (b) is such that it is impossible to attach a high-intensity obstacle light to the top of the appurtenance;

then the high-intensity obstacle light must be attached to the highest possible point of the appurtenance.

- (5) For the following:
  - (a) an extensive object or structure;
  - (b) a group of closely-spaced objects or structures;

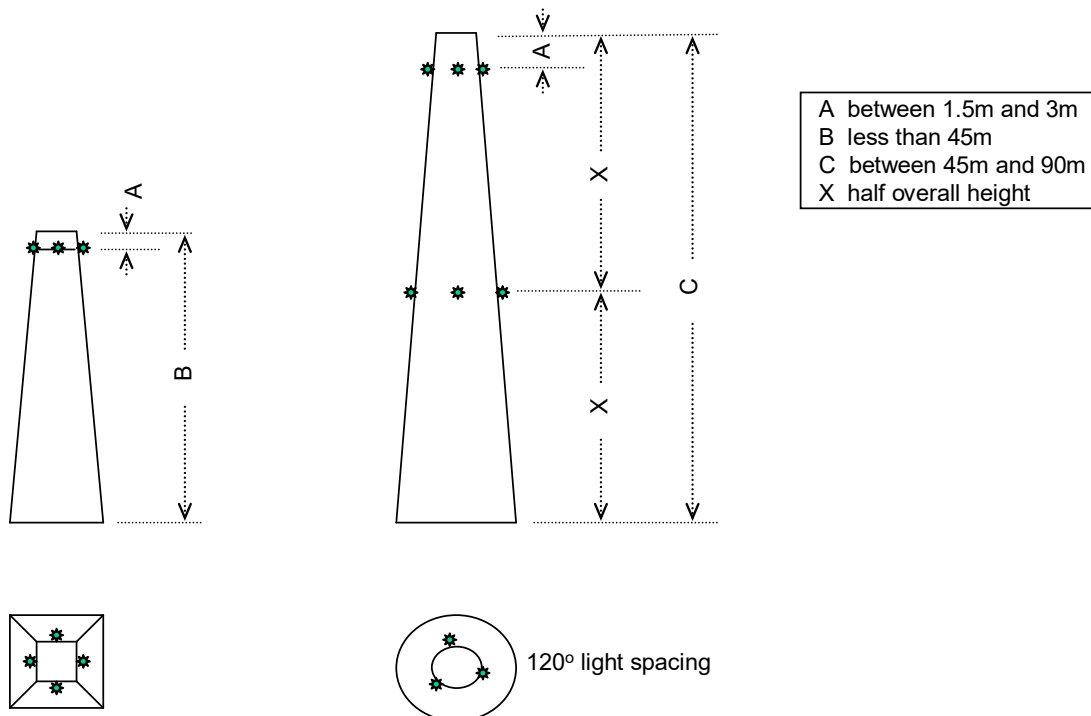
the obstacle lights must be located in such numbers, and in such arrangements, as to ensure that the lights clearly indicate at least:

- (c) the points or edges of the object or structure that are highest above the obstacle limitation surface; and
  - (d) the general definition and extent of the object or structure; and
  - (e) if 2 or more edges are at the same height — the edge nearest to the runway threshold.
- (6) For subsection (5):
- (a) if low-intensity lights are used — the lights must be spaced at longitudinal intervals not exceeding 45 m; and
  - (b) if medium-intensity lights are used:
    - (i) the lights must be spaced at longitudinal intervals not exceeding 900 m; and
    - (ii) at least 3 lights must be displayed as a line of lights, horizontally on the side of an extensive object or structure that is nearest to the runway threshold.
- (7) Shielding of the downward component of obstacle lighting is permitted, and if used must be such that:
- (a) no more than 5% of the nominal light intensity is emitted at or below 5 degrees below horizontal; and
  - (b) no light is emitted at or below 10 degrees below horizontal.
- (8) Subject to subsection (9), for wind turbines in a wind farm, medium-intensity obstacle lights must:
- (a) mark the highest point reached by the rotating blades; and
  - (b) be provided on a sufficient number of individual wind turbines to indicate the general definition and extent of the wind farm, but such that intervals between lit turbines do not exceed 900 m; and
  - (c) all be synchronised to flash simultaneously; and
  - (d) be seen from every angle in azimuth.
- Note* This is to prevent obstacle light shielding by the rotating blades of a wind turbine and may require more than 1 obstacle light to be fitted.
- (9) If it is physically impossible to light the rotating blades of a wind turbine:
- (a) the obstacle lights must be placed on top of the generator housing; and
  - (b) a note must be published in the AIP-ERSA indicating that the obstacle lights are not at the highest position on the wind turbines.
- (10) If the top of an object or structure is more than 45 m above:
- (a) the surrounding ground (**ground level**); or
  - (b) the top of the tallest nearby building (**building level**);
- then the top lights must be medium-intensity lights, and additional low-intensity lights must be:
- (c) provided at lower levels to indicate the full height of the structure; and

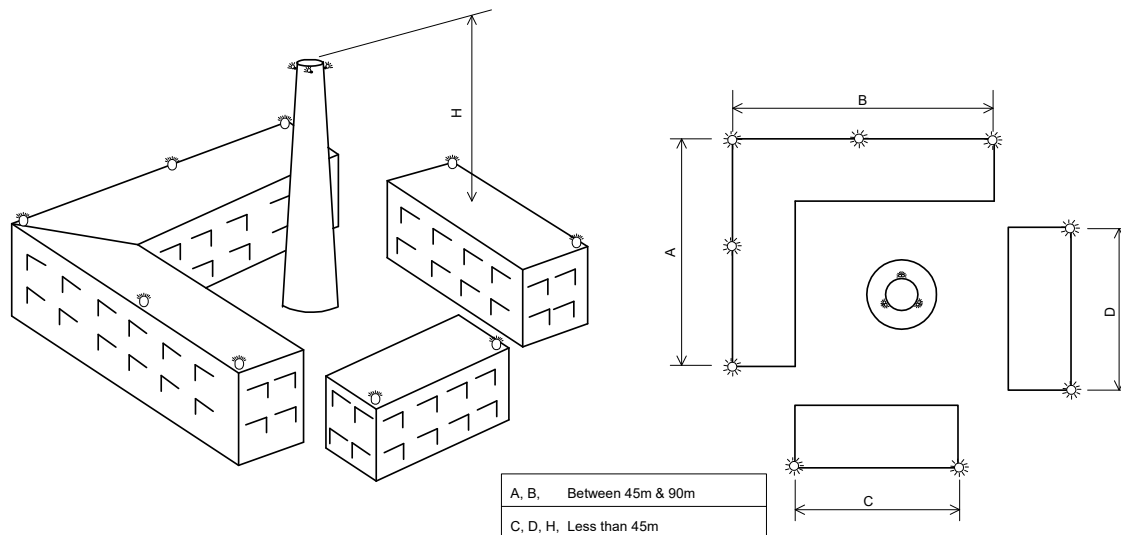
- (d) spaced as equally as possible between the top lights and the ground level or building level, but not so as to exceed 45 m between lights.
- (11) If high-intensity obstacle lights are used:
  - (a) on an object or structure that is not a tower supporting wires or cables — the spacing between the lights must not exceed 105 m; and
  - (b) on an object or structure that is a tower supporting wires or cables — the lights must be located on the tower as follows:
    - (i) at the top of the tower;
    - (ii) at the point of the tower that is the lowest level of the catenary of the wires or cables;
    - (iii) at approximately midway between the 2 levels referred to in subparagraphs (i) and (ii).

*Note* In some cases, paragraph (b) may require the bottom and middle lights to be located off the tower on stand-alone supports.

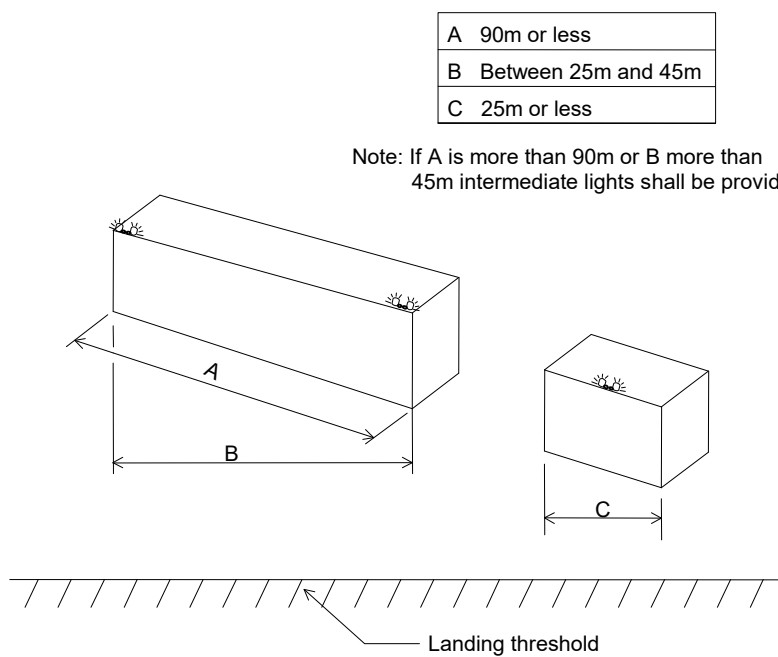
- (12) For subsection (11):
  - (a) the number and arrangement of lights at each level mentioned in subparagraphs (11) (b) (i), (ii) and (iii) must be such that the object or structure is indicated from every angle of azimuth; and
  - (b) if a light would be shielded in any direction by an adjacent object or structure, the light so shielded may be omitted, provided that such additional lights are used as are necessary to retain the general definition of the object or structure.



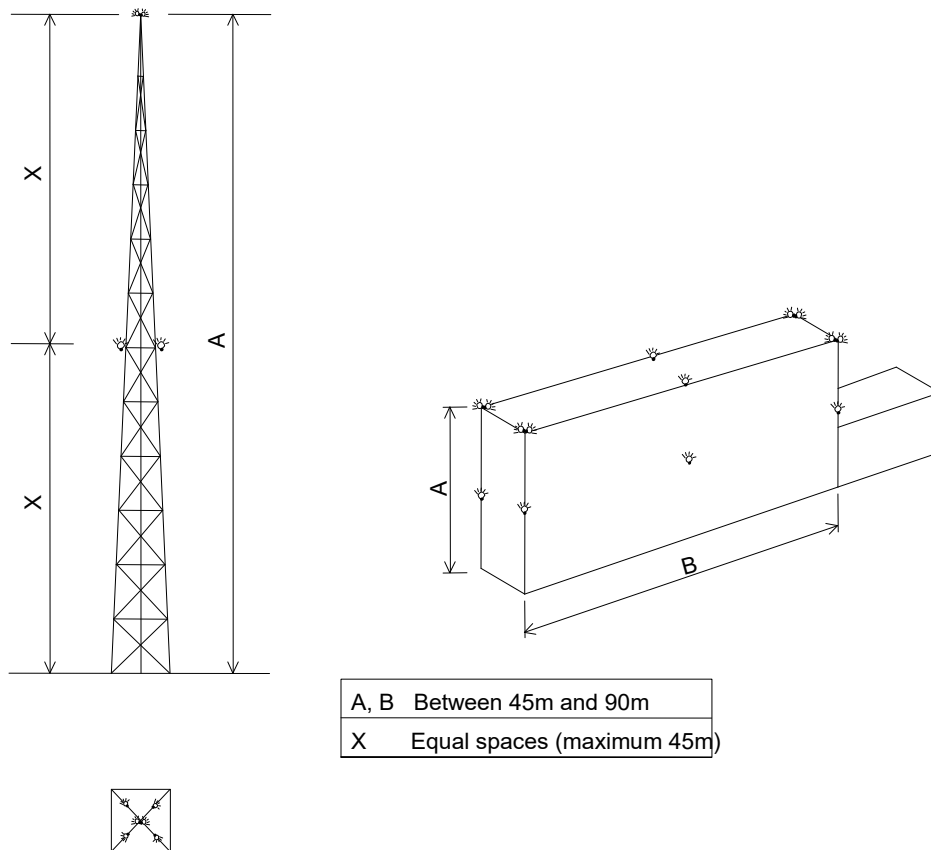
**Figure 9.31 (1)-1 Typical lighting of tall hazardous obstacles (illustrates matters)**



**Figure 9.31 (1)-2 Typical lighting of a group of hazardous obstacles (illustrates matters)**



**Figure 9.31 (1)-3 Typical lighting of horizontally-extended hazardous obstacles (illustrates matters)**



**Figure 9.31 (1)-4 Typical lighting of towers and large hazardous obstacles (illustrates matters)**

### 9.32 Characteristics of low-intensity obstacle lights

- (1) Low-intensity obstacle lights must have the following:
  - (a) fixed lights showing red;
  - (b) a horizontal beam spread that results in 360-degree coverage around the obstacle;
  - (c) a minimum intensity of 100 candela (*cd*);
  - (d) a vertical beam spread (to 50% of peak intensity) of 10 degrees;
  - (e) a vertical distribution with 50 cd minimum at +6 degrees and +10 degrees above the horizontal;
  - (f) not less than 10 cd at all elevation angles between -3 degrees and +90 degrees above the horizontal.

*Note* The intensity requirement in paragraph (c) may be met using a double-bodied light fitting. CASA recommends that double-bodied light fittings, if used, should be orientated so that they show the maximum illuminated surface towards the predominant, or more critical, direction of aircraft approach.

- (2) To indicate the following:
  - (a) taxiway obstacles;
  - (b) unserviceable areas of the movement area;
 low-intensity obstacle lights must have a peak intensity of at least 10 cd.

### 9.33 Characteristics of medium-intensity obstacle lights

- (1) Medium-intensity obstacle lights must:
  - (a) be visible in all directions in azimuth; and
  - (b) if flashing — have a flash frequency of between 20 and 60 flashes per minute.
- (2) The peak effective intensity of medium-intensity obstacle lights must be  $2\,000 \pm 25\%$  cd with a vertical distribution as follows:
  - (a) for *vertical beam spread* — a minimum of 3 degrees;
  - (b) at -1 degree elevation — a minimum of 50% of the lower tolerance value of the peak intensity;
  - (c) at 0 degrees elevation — a minimum of 100% of the lower tolerance value of the peak intensity.
- (3) For subsection (2), *vertical beam spread* means the angle between 2 directions in a plane for which the intensity is equal to 50% of the lower tolerance value of the peak intensity.
- (4) If, instead of obstacle marking, a flashing white light is used during the day to indicate temporary obstacles in the vicinity of an aerodrome, the peak effective intensity of the light must be increased to  $20\,000 \pm 25\%$  cd when the background luminance is 50 cd/m<sup>2</sup> or greater.

### 9.34 Characteristics of high-intensity obstacle lights

- (1) High-intensity obstacle lights are flashing white lights.
- (2) The effective intensity of a high-intensity obstacle light located on an object or structure, other than a tower supporting overhead wires or cables, must vary depending on background luminance as follows:
  - (a)  $200\,000 \pm 25\%$  cd effective intensity at a background luminance above 500 cd/m<sup>2</sup>;
  - (b)  $20\,000 \pm 25\%$  cd effective intensity at a background luminance between 50-500 cd/m<sup>2</sup>;
  - (c)  $2\,000 \pm 25\%$  cd effective intensity at a background luminance below 50 cd/m<sup>2</sup>.
- (3) The effective intensity of a high-intensity obstacle light located on a tower supporting overhead wires or cables must vary depending on background luminance as follows:
  - (a)  $100\,000 \pm 25\%$  cd effective intensity at a background luminance above 500 cd/m<sup>2</sup>;
  - (b)  $20\,000 \pm 25\%$  cd effective intensity at a background luminance between 50-500 cd/m<sup>2</sup>;
  - (c)  $2\,000 \pm 25\%$  cd effective intensity at a background luminance below 50 cd/m<sup>2</sup>.
- (4) High-intensity obstacle lights located on an object or structure, other than a tower supporting overhead wires or cables, must flash simultaneously at a rate between 40-60 flashes per minute.
- (5) High-intensity obstacle lights located on a tower supporting overhead wires or cables must flash:
  - (a) sequentially in a cycle as follows: first the middle light, next the top light, and last the bottom light; and
  - (b) with a cycle frequency of 40-60 flashes per minute; and

- (c) within a cycle — so that the interval between the flashes of each of the lights mentioned in a row of column 1 of Table 9.34 (5) is as close as possible to the proportion of the cycle time mentioned in the same row in column 2.

**Table 9.34 (5) High-intensity obstacle light flash rates**

Flash interval between	Proportion of cycle time
middle and top light	1/13
top and bottom light	2/13
bottom and middle light	10/13

- (6) Unless otherwise directed in writing by CASA, the installation setting angles for high-intensity obstacle lights must be in accordance with Table 9.34 (6) so that for an obstacle light at a height mentioned in a row of column 1, the angle of the peak of the light beam above the horizontal is the value mentioned in the same row in column 2.

**Table 9.34 (6) High-intensity light installation setting angles**

Height of light above terrain	Angle of the peak of the beam above the horizontal
greater than 151 m	0°
122 m to 151 m	1°
92 m to 122 m	2°
less than 92 m	3°

### 9.35 Floodlighting of hazardous obstacles

*Note* Where the installation of obstacle lights in accordance with this MOS is not possible, or is undesirable for aesthetic or other reasons, floodlighting of obstacles may be an appropriate alternative. However, floodlighting may cause a hazard to pilots and a review and acknowledgment process is required (see subsection 9.35 (1)). In general, floodlighting is not suitable if:

- (a) the structure is skeletal, as a substantially solid surface or cladding with satisfactory reflectance properties is required; or
  - (b) there is high-level background lighting.
- (1) Floodlighting may be used for a hazardous obstacle instead of obstacle lights, but only if CASA approves in writing receipt of an aerodrome operator's explanation of why the installation of obstacle lights is not possible, or is undesirable for aesthetic or other reasons.
- (2) If floodlighting is used:
- (a) the colour must be white; and
  - (b) illumination of the object or structure must:
    - (i) cover all directions of azimuth over the full height portion of the object or structure which needs to be illuminated; and
    - (ii) be uniform around the circumferences of the object or structure.
- (3) For subsection (2), the minimum level of luminance must be 5 cd/m<sup>2</sup> at all points.

*Note* Based on a reflectance factor of 50% for white paint, this would require illuminance of at least 10 lux. For concrete with a typical reflectance factor of 40%, the required illuminance would be at least 12.5 lux. Materials with reflectance factors less than 30% are unlikely to be suitable for floodlighting.

- (4) For subsection (2):
  - (a) each floodlight fitting must be located evenly around the object or structure, at not more than 120 degrees from any adjacent floodlight fitting; and
  - (b) at each location:
    - (i) there must be at least 2 floodlight fittings; and
    - (ii) each fitting must be on a separate circuit and capable of continuing to operate following the malfunction of another light.

### 9.36 Serviceability of obstacle lights

- (1) For obstacle lights located within the OLS of an aerodrome, the aerodrome operator must establish an obstacle lights serviceability monitoring program that includes the following elements:
  - (a) for aerodromes with scheduled international air transport operations during the hours of night — observation of the obstacle lights at least once in every 24 hour period, or such longer period as CASA approves in writing on the basis of the aerodrome operator’s written safety assessment;
  - (b) for aerodromes with scheduled domestic air transport operations during the hours of night — observation of the obstacle lights at least once in every 48 hour period, or such longer period as CASA approves in writing on the basis of the aerodrome operator’s written safety assessment;
  - (c) for aerodromes other than those mentioned in paragraphs (a) and (b) — observation of the obstacle lights at least once in every 7 day period;
  - (d) if a medium-intensity or high-intensity obstacle light is not readily observable for paragraph (a), (b) or (c):
    - (i) a procedure to ensure that the light is monitored in accordance with the relevant monitoring period specified in paragraph (a), (b) or (c), or such longer period as CASA approves in writing on the basis of the aerodrome operator’s written safety assessment; or
    - (ii) at an aerodrome occupied by aerodrome personnel — the installation of an automatic light-failure indicator to be monitored by the personnel.
- (2) For a hazardous obstacle located within the OLS of the aerodrome, if there is an obstacle light outage then the aerodrome operator must:
  - (a) immediately request the NOTAM Office to advise pilots of the details of the outage; and
  - (b) as soon as possible, liaise with the owner of the obstacle light so that the outage is repaired as quickly as possible; and
  - (c) if the obstacle light is determined by CASA, in writing, as essential for aviation safety:
    - (i) immediately report the outage to any aircraft that are manoeuvring, or are about to manoeuvre, on an affected runway; and
    - (ii) immediately close the runway or close the aerodrome, as the case requires, until the outage is repaired; and
    - (iii) notify CASA as soon as possible of the outage.

*Note* For CASA determining that an obstacle light is essential for aviation safety, see subsection 7.19 (1).



- (3) The aerodrome operator's aerodrome manual must include the following:
- (a) details of, and procedures for, the obstacle lights serviceability monitoring program;
  - (b) the procedures to be followed when an obstacle light outage occurs;
  - (c) details of the following:
    - (i) any CASA approval under paragraph (1) (a), (1) (b) or (1) (d);
    - (ii) any CASA determination mentioned in paragraph (2) (c).

## CHAPTER 9

### Division 5 Aerodrome lighting systems

#### 9.37 Aerodrome beacons

- (1) An aerodrome operator may provide an aerodrome beacon.
- (2) If an aerodrome beacon is provided, it must be located as follows:
  - (a) on the surface of, or adjacent to, the aerodrome;
  - (b) in an area of low ambient background lighting;
  - (c) such that it is not shielded by obstacles;
  - (d) such that it is not dazzling to a pilot making an approach to land.
- (3) Subject to subsection (4), an aerodrome beacon at an aerodrome must show white flashes only.
- (4) An aerodrome beacon at:
  - (a) an international aerodrome; or
  - (b) an aerodrome in a built-up area;must give 2 alternating flashes, 1 white and the other coloured green.
- (5) For subsection (4), the effective intensity of the green flashes must not be less than 0.15 times the intensity of the white flashes at the corresponding angle of elevation.
- (6) Subject to subsection (7), for any aerodrome beacon, the frequency of flashes must be from 20 to 30 flashes per minute.
- (7) The light from an aerodrome beacon must be visible from all angles of azimuth.
- (8) The light intensity distribution of an aerodrome beacon must be such that for an elevation angle mentioned in a row in column 1 of Table 9.37 (8), the minimum effective intensity of white flashes must be that shown in the same row in column 2.

**Table 9.37 (8) Aerodrome beacon light intensity distribution**

Elevation angle (in degrees)	Minimum effective intensity of white flashes (in candelas)
1 to 2	25 000
2 to 8	50 000
8 to 10	25 000
10 to 15	5 000
15 to 20	1 000

#### 9.38 Illuminated wind direction indicators

- (1) Without affecting subsection (2), at an aerodrome intended for night use, at least 1 wind direction indicator (*WDI*) must be lit in accordance with this section.

- (2) If an additional WDI is provided in the vicinity of the threshold of an instrument runway, the WDI must be lit at night as an illuminated WDI (*IWDI*) unless:
  - (a) surface wind information is available through a broadcast aerodrome weather information service (an *AWIS*) or a person mentioned in regulation 120 of CAR; or
  - (b) the instrument approach procedure for the runway is restricted to daytime operations only.

*Note* CASA recommends that an IWDI should be provided at the threshold of all runways that are available for use at night.

- (3) For an IWDI, floodlighting must be used:
  - (a) to illuminate the IWDI from above; and
  - (b) to illuminate the IWDI sleeve from all directions of azimuth simultaneously.
- (4) For subsection (3), the IWDI sleeve must be illuminated by at least 4 separated lamp units that together provide at least 100 lux illumination to all points of the horizontal plane passing through the top of the IWDI sleeve at the supporting pole end for the 360-degree area swept by the fully-extended sleeve.

*Note* An acceptable method of verification for illumination is to measure illumination levels on the horizontal plane passing through the top of the sleeve at the pole end. CASA recommends that measurements should be taken at 1 m intervals starting at the pole and working outwards on a radial to the pole to a range equal to the length of the fully-extended sleeve. The outermost interval on each radial may be less than 1 m to correspond with the actual length of the sleeve. The radials should be at 30-degree intervals. Each reading must be at least 100 lux.

- (5) For an IWDI, the lighting must:
  - (a) ensure accurate colour rendering; and
  - (b) have no perceptible warm-up or re-strike delay.
- (6) If there is only one IWDI then control of its lighting must be incorporated in each runway's lighting control, so that activating any runway lighting system automatically activates the IWDI lighting.
- (7) If there is more than one IWDI, control of the lighting of each IWDI must be incorporated into the runway lighting control for the runway that the IWDI serves.
- (8) If the power supply to an IWDI is from a runway lighting circuit with intensity control, the IWDI light intensity must be in accordance with subsection (4) irrespective of the intensity setting of the runway lighting.
- (9) If a PAL is installed then the IWDI lighting must be programmed in such a way that 10 minutes before the end of the aerodrome lighting "on" period, the lights of at least 1 IWDI will:
  - (a) start to flash, at between 40 to 50 flashes per minute; and
  - (b) continue to flash until the PAL:
    - (i) switches off, and all other aerodrome lighting is extinguished; or
    - (ii) has been reset for another "on" period.
- (10) If the PAL is reset for another "on" period, the lights of any flashing IWDI mentioned in subsection (9) must return from flashing to steady lighting.

## CHAPTER 9

### Division 6 Simple approach lighting

#### 9.39 Simple approach lighting system

- (1) An aerodrome operator may provide a simple approach lighting system (**SALS**) to serve a non-precision approach, or non-instrument, runway.

*Note 1* Depending on the runway's length, a SALS can provide an operational benefit by reducing the minimum visibility or RVR requirements for an instrument approach conducted to the runway.

*Note 2* A SALS can enhance visual guidance for a non-instrument runway.

- (2) A SALS must:
  - (a) consist of a row of lights on the extended centreline of a runway, as illustrated in Figure 9.39 (2), within a tolerance of  $\pm 15'$ ; and
  - (b) subject to subsection 9.40 (3), as far as possible have a length of at least 420 m.

*Notes*

1. As the length of a SALS increases from 210 m to 719 m, there can be a corresponding reduction in the minimum visibility or RVR requirements for an instrument approach conducted to that runway.
  2. While a SALS shorter than 210 m may enhance visual guidance, it provides no benefit in operating minima over a runway that is not equipped with an approach lighting system.
  3. There is no additional operational benefit achievable with a SALS equal to or longer than 720 m.
  4. CASA recommends that aerodrome operators should consult an instrument flight procedure designer for specific information about the impact of approach lighting on operating minima.
- (3) If the length of the SALS is 300 m or more, a row of lights forming a crossbar must be provided at a Point B as shown in Figure 9.39 (2).
  - (4) For subsection (3), the crossbar must be:
    - (a) 18 m in length for runways less than 30 m wide; and
    - (b) 30 m in length for runways with a width of 30 m or more.
  - (5) An additional crossbar may be provided at a Point A as shown in Figure 9.39 (2) if:
    - (a) the SALS uses a centreline with single light sources; and
    - (b) there is a crossbar at Point B.
  - (6) The lights forming a crossbar in a SALS must be:
    - (a) as nearly as possible in a horizontal straight line at right angles to, and bisected by, the line of the centreline lights; and
    - (b) spaced so as to produce a linear effect, except that gaps may be left on each side of the centreline, provided:
      - (i) the spacing of gaps each side of the centreline is kept to a minimum necessary to meet local requirements; and
      - (ii) no gap exceeds 6 m.
  - (7) Subject to paragraph (6) (b), all spaces between crossbar lights must be:
    - (a) at least 1 m, but not more than 4 m; and
    - (b) equal to each other.

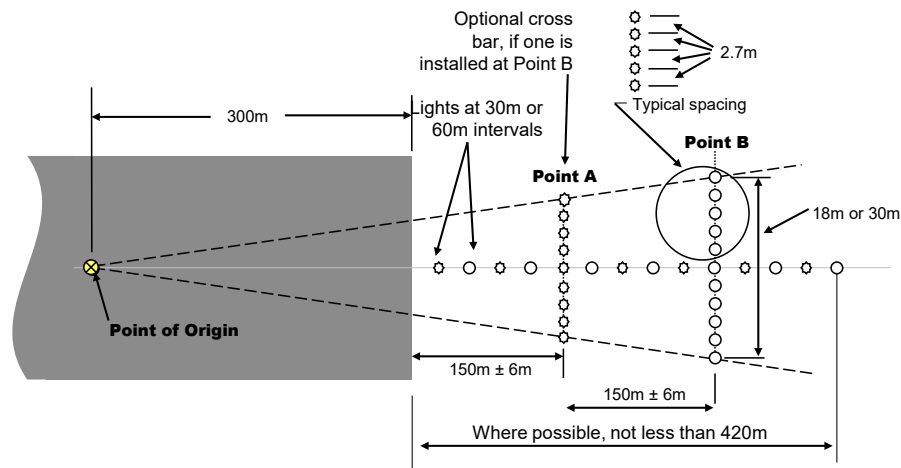
*Note* Gaps on each side of the centreline may improve directional guidance when approaches are made with a lateral error, and may facilitate the movement of rescue and firefighting vehicles. See ICAO Annex 14,

Aerodromes, Volume 1, Aerodrome Design and Operations, Attachment A, Section 11, for guidance on installation tolerances. For ICAO documents, see section 1.07.

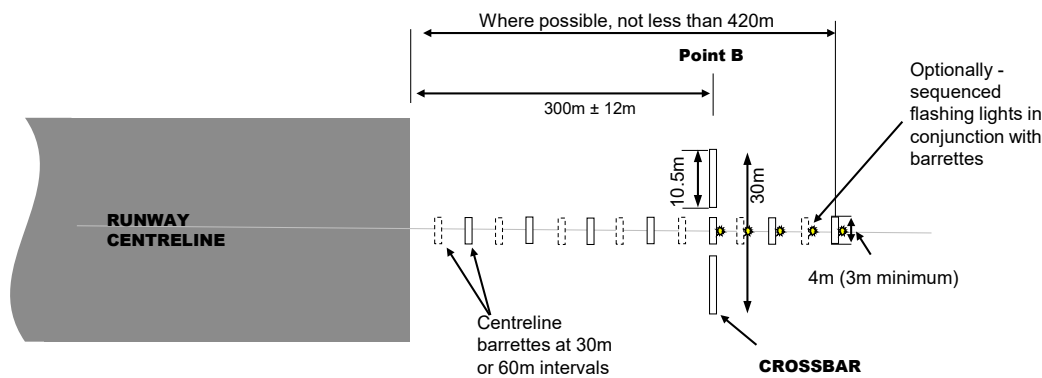
- (8) As shown in Figure 9.39 (2), in a SALS, the lights forming the centreline must be positioned with longitudinal intervals of 60 m, within a tolerance of  $\pm 2$  m, with the innermost light located 60 m from the threshold, except that:
  - (a) if it is desired to improve the guidance provided by the lights, an interval of 30 m, within a tolerance of  $\pm 2$  m, may be used with the innermost light located 30 m from the threshold; and
  - (b) the spacing between the centreline lights or barrettes may be adjusted to ensure even spacing between crossbars or between crossbar and threshold.

*Note* Centreline lights installed at 30 m intervals would maximise the probability of pilots acquiring sufficient visual reference to complete an instrument approach to landing.

- (9) The SALS must lie as nearly as possible in the horizontal plane passing through the threshold, and be such that:
  - (a) no object or structure, other than an ILS azimuth antenna, protrudes through the plane of the approach lights within a distance of 60 m from the centreline of the system; and
  - (b) no light, other than a light located within the central part of a crossbar or a centreline barrette (not their extremities), is screened from an approaching aircraft.
- (10) An ILS azimuth antenna protruding through the plane of the SALS must be treated as an obstacle and marked and lighted as an obstacle.



A – Single source centreline



B – Barrette centreline

**Figure 9.39 (2) Simple approach lighting system (shows matters)**

#### 9.40 Simple approach lighting system — additional requirements

- (1) The lights of a SALS must be:
  - (a) for a SALS installed in conjunction with high-intensity runway lighting:
    - (i) fixed lights showing variable white; and
    - (ii) in accordance with the specifications in Figure 9.43 (1)-1; and
  - (b) for a SALS installed in conjunction with low or medium-intensity runway lighting:
    - (i) omnidirectional fixed lights showing variable white; and
    - (ii) of an intensity and light distribution compatible with the respective standards for the installed low or medium-intensity runway lighting.
- (2) Subject to subsection (3), each centreline light of a SALS must consist of either:
  - (a) a single source; or
  - (b) a barrette at least 3 m in length.

*Note* If it is anticipated that the SALS will be developed into a precision approach lighting system, it is recommended that the centreline lights are represented by barrettes of 4 m in length rather than a single source centreline.

- (3) If it is not physically practicable to provide a centreline extending for a distance of 420 m from the threshold:
  - (a) the SALS must be at least 300 m in length as to include the crossbar; and
  - (b) each centreline light must consist of a barrette at least 3 m in length.

*Note* Subject to the approach system having a crossbar at 300 m from the threshold, an additional crossbar at 150 m from the threshold is recommended.

- (4) If identification of a SALS is difficult at night because of light pollution from surrounding lights, sequenced flashing lights, conforming to the requirements of subsection 9.41 (10), may be installed but only in the outer portion of the SALS associated with a barrette centreline.

## CHAPTER 9

### Division 7 Precision approach CAT I, II and III lighting systems

#### 9.41 Precision approach CAT I lighting system

- (1) A precision approach CAT I lighting system must be provided to serve a precision approach CAT I runway supporting instrument approach operations with a visibility less than 1 500 m.
- (2) As shown in Figure 9.41 (2), a precision approach CAT I lighting system must consist of a row of lights on the extended centreline of the runway extending, within a tolerance of  $\pm 15'$ , at least to Point B, with a row of lights forming a crossbar 30 m in length at Point B.

*Note 1* The design objective for a precision approach CAT I lighting system that utilises a distance-coded centreline should be a system length of 900 m (adjustable for the tolerances shown in Figure 9.41 (2)). This length enables full design layout of this form of approach lighting system.

*Note 2* CASA recommends that for a precision approach CAT I lighting system using a barrette centreline to be considered a full approach lighting system, the design objective should be a system length of at least 720 m.

*Note 3* Any precision approach CAT I lighting system that has a length of less than 720 m will likely require compensating increases by the terminal instrument flight procedure designer to the minimum visibility or RVR requirements for any instrument approach conducted to that runway.

*Note 4* CASA recommends that aerodrome operators should consult aircraft operators and an instrument flight procedure designer for specific information about the limitations or impact on operating minima of the length and type of approach lighting.

- (3) The lights forming the crossbar must be:
  - (a) as nearly as possible in a horizontal straight line at right angles to, and bisected by, the line of the centreline lights; and
  - (b) spaced so as to produce a linear effect, except that gaps may be left on each side of the centreline provided:
    - (i) the spacing of the gaps either side of the centreline is kept to a minimum necessary to meet local requirements; and
    - (ii) no gap exceeds 6 m.
- (4) Subject to paragraph (3) (b), all spaces between crossbar lights must be:
  - (a) at least 1 m, but not more than 4 m; and
  - (b) equal to each other.

*Note* Gaps on each side of the centreline may improve directional guidance when approaches are made with a lateral error, and may facilitate the movement of rescue and firefighting vehicles. See ICAO Annex 14, Aerodromes, Volume 1, Aerodrome Design and Operations, Volume I, Attachment A, Section 11 for guidance on installation tolerances. For ICAO documents, see section 1.07.

- (5) As shown in Figure 9.41 (2), the lights forming the centreline must be placed:
  - (a) at equal longitudinal intervals between the crossbars, or between a crossbar and the threshold, the intervals being, or being as close as possible to, 30 m and not exceeding  $\pm 2$  m, with the innermost light located 30 m from the threshold; or

*Note* Due to the location of existing fences, access roads and navigational arrays, it might not be possible to space the centreline lights at 30 m in a section of the approach lighting array. Consistent spacings, as close as possible to 30 m, will ensure the correct perception of the visual aid by flight crews.



Aerodrome operators are recommended to consult with relevant aircraft operators when designing approach lighting arrays.

- (b) if crossbars are placed with the application of allowable spacing tolerances shown in Figure 9.41 (2) — such that they are at equidistant intervals between:
    - (i) the runway threshold and the first crossbar; and
    - (ii) any other crossbars.
  - (6) The lighting system must lie as nearly as possible in the horizontal plane passing through the threshold, and be such that:
    - (a) no object, obstacle or structure, other than an ILS localiser antenna or a far field monitor antenna, protrudes through the plane of the approach lights within a distance of 60 m from the centreline of the system; and
    - (b) no light, other than a light located within the central part of a crossbar or a centreline barrette (not their extremities), is screened from an approaching aircraft.
- Note* All roads and highways are considered as obstacles extending 4.8 m above the crown of the road, except aerodrome service roads where all vehicular traffic is under control of the aerodrome authorities and coordinated with the aerodrome traffic control tower. Railroads, regardless of the amount of traffic, are considered as obstacles extending 5.4 m above the top of the rails.
- (7) An ILS localiser antenna or a far field monitor antenna protruding through the plane of the lights must be treated as an obstacle, and marked and lighted as an obstacle.
  - (8) The centreline and crossbar lights of a precision approach CAT I lighting system must:
    - (a) be fixed lights showing variable white; and
    - (b) for each centreline light position — consist of:
      - (i) 1 light source from the runway threshold to Point B, 2 light sources from Point B to Point D and 3 light sources beyond Point D, to provide distance information; or
      - (ii) a barrette.
  - (9) A barrette must be:
    - (a) at least 4 m in length; and
    - (b) if composed of lights approximating to point sources — composed of such lights uniformly spaced at intervals of not more than 1.5 m.
  - (10) If the centreline consists of barrettes, each barrette that is at or beyond Point B (in the direction towards the end of the array of barrettes) must be supplemented by a sequenced flashing light, which must:
    - (a) be flashed twice a second in sequence, beginning with the outermost light of the system, and progressing toward the threshold to the innermost light; and
    - (b) be of such electrical circuit design that it can be operated independently of the other lights of the approach lighting system; and
    - (c) have a minimum effective intensity of 15 000 cd  $\pm$  50%.

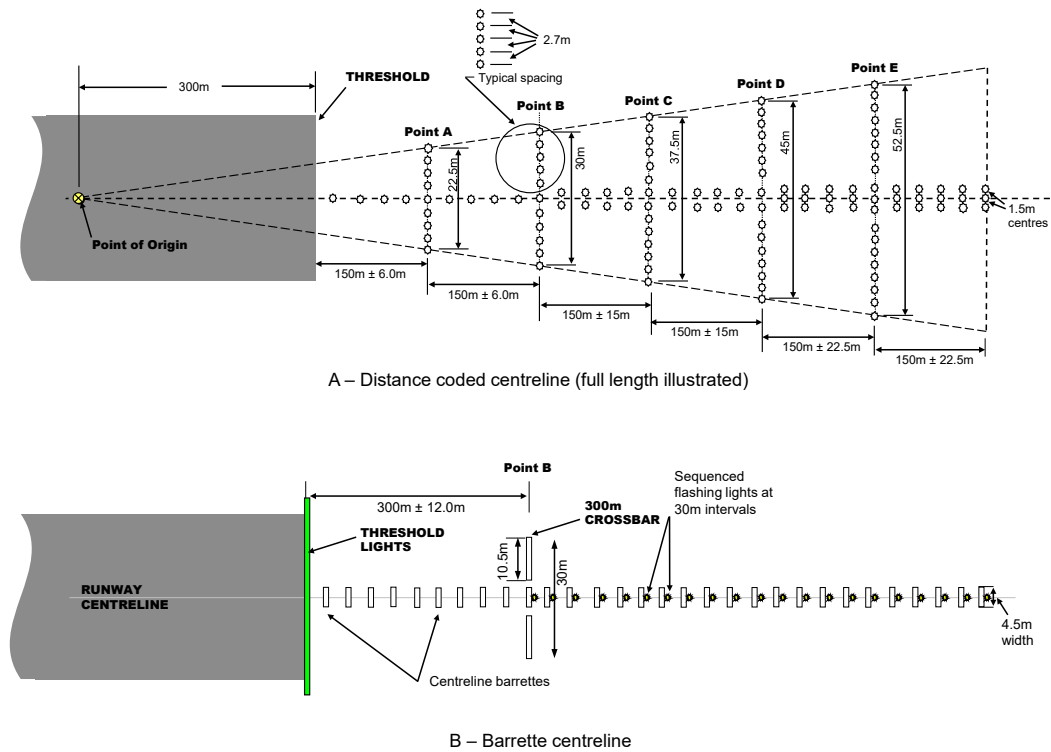
*Note* See FAA *Advisory Circular 150/5345-51*, as in force or existing from time to time and freely available from the FAA website, [www.faa.gov](http://www.faa.gov), for further information.

- (11) If the centreline consists of lights as described in subsections (8), (9) and (10):
- (a) additional crossbars of lights (that is, additional to the crossbar of lights at Point B) must be provided at Points A, C, D and E (where these locations are covered within the overall length of the system); and
  - (b) the lights forming each crossbar must be:
    - (i) as nearly as possible in a horizontal straight line at right angles to, and bisected by, the line of the centreline lights; and
    - (ii) spaced so as to produce a linear effect, except that gaps may be left on each side of the centreline provided:
      - (A) the number of gaps is kept to a minimum to meet local requirements; and
      - (B) no gap exceeds 6 m.
- (12) If the additional crossbars described in subsection (11) are incorporated in the system, the outer ends of the crossbars must lie on 2 straight lines that converge to meet the runway centreline 300 m from the threshold.

*Note* Figure 9.41 (2) shows both kinds of precision approach CAT I lighting configuration mentioned in this section.

- (13) For this section, the light intensities must be in accordance with the specifications of Figure 9.43 (1)-1.

*Note* ICAO Annex 14, Aerodromes, Volume I, Aerodrome Design and Operations, Attachment A, Section 11, provides information on the flight path envelopes used in the design of these lights. For ICAO documents, see section 1.07.



**Figure 9.41 (2) Precision approach CAT I lighting system (shows matters)**

## 9.42 Precision approach CAT II and CAT III lighting system

- (1) A precision approach CAT II and CAT III lighting system must be provided to serve a precision approach CAT II or CAT III runway.
- (2) Where a precision approach CAT II and CAT III lighting system is provided, touchdown zone lights must also be provided.

### Approach lighting system

- (3) As shown in Figure 9.42 (3) and subject to subsection (4), the approach lighting system must consist of a row of lights on the extended centreline of the runway extending at least to Point B, with:
  - (a) 2 side rows of lights, extending between the threshold and Point B; and
  - (b) 2 crossbars, 1 at 150 m and 1 at 300 m from the threshold, at Points A and B.
- (4) A precision approach CAT II or CAT III lighting system that has a total length of less than 420 m may be provided to support instrument approach operations type B (CAT II) only if a safety and operational assessment has established that the selected length of approach lighting is suitable for the operations.

*Note 1* The design objective for a precision approach CAT II or CAT III lighting system that utilises a distance-coded centreline should be a system length of 900 m. This length enables full design layout of this form of approach lighting system and enables, in addition to CAT II or III operations, lowest visibility or RVR minima for other instrument approach operations.

*Note 2* The design objective for a precision approach CAT II or CAT III lighting system that utilises a barrette centreline should be a system length of between 720 m and 900 m. This length enables, in addition to CAT II or CAT III operations, lowest visibility or RVR minima for other instrument approach operations.

*Note 3* A precision approach CAT II or CAT III lighting system that has a length of less than 720 m will require compensating increases in the visibility or RVR minima for other instrument approach operations conducted to that runway.

- (5) As shown in Figure 9.42 (3), the centreline lights must be:
- (a) at equal longitudinal intervals between the crossbars, or between a crossbar and the threshold, as close as possible to 30 m and not exceeding  $\pm 2$  m; or
  - (b) if crossbars are placed with the application of the allowable plus or minus tolerances shown in Figure 9.42 (3) — such that they are at equidistant intervals between the runway threshold and the first crossbar and between any other crossbars.

*Note* Due to the location of existing fences, access roads and navigational arrays, it might not be possible to space the centreline lights at 30 m in a section of the approach lighting array. Consistent spacings, as close as possible to 30 m, will ensure the correct perception of the visual aid by flight crew. Aerodrome operators are recommended to consult with their aircraft operators when designing approach lighting arrays.

### Side row lights

- (6) The side row lights must be placed:
- (a) on each side of the centreline; and
  - (b) at a longitudinal spacing equal to that of the centreline lights; and
  - (c) aligned with the centreline lights; and
  - (d) so that the lateral spacing between the innermost lights of the side rows is:
    - (i) not less than 18 m nor more than 22.5 m; and
    - (ii) within the limits specified in subparagraph (i) — as close as possible to the spacing between the runway touchdown zone lights.

### Crossbar lights

- (7) The crossbar provided at Point A must fill in the gaps between the centreline and side row lights.
- (8) The crossbar provided at Point B must extend on both sides of the centreline lights to a distance of 15 m from the centreline.
- (9) If the centreline beyond Point B consists of lights as described in subsection (14), additional crossbars of lights must be provided at Points C, D and E (where these locations are included within the overall length of the system).
- (10) If the additional crossbars described in subsection (9) are incorporated in the system, the outer ends of these crossbars must lie on 2 straight lines that converge to meet the runway centreline 300 m from the threshold.
- (11) The lighting system must lie as nearly as possible in the horizontal plane passing through the threshold, and be such that:
- (a) no object, obstacle or structure, other than an ILS localiser antenna or a far field monitor antenna, may protrude through the plane of the approach lights within a distance of 60 m from the centreline of the system; and

*Note* All roads and highways are considered as obstacles extending 4.8 m above the crown of the road, except aerodrome service roads where all vehicular traffic is under control of the aerodrome authorities and coordinated with the aerodrome traffic control tower. Railroads, regardless of the amount of traffic, are considered as obstacles extending 5.4 m above the top of the rails.

- (b) no light, other than a light located within the central part of a crossbar or a centreline barrette (not their extremities), may be screened from an approaching aircraft.
- (12) An ILS localiser antenna or a far field monitor antenna protruding through the plane of the lights must be treated as an obstacle and marked and lighted as an obstacle.

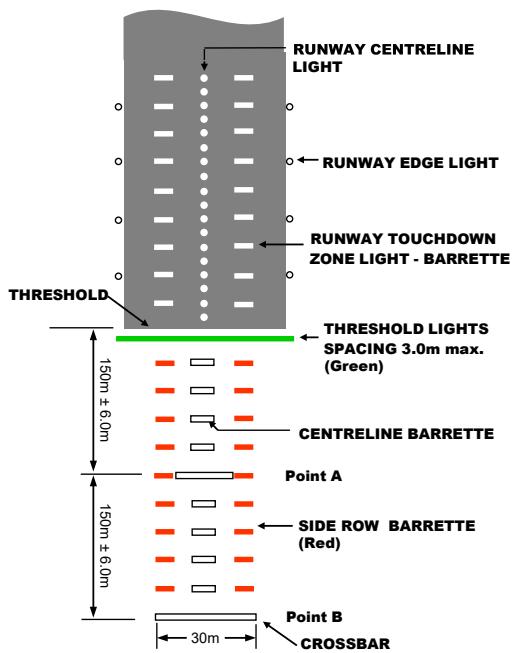
#### Centreline lights

- (13) The centreline of a precision approach CAT II or CAT III lighting system from the threshold to Point B must consist of barrettes showing variable white. However, if the threshold is displaced 300 m or more, the centreline may consist of single light sources showing variable white.
- (14) Beyond Point B, each centreline light position must consist of 1 of the following, each of which must show variable white light:
  - (a) 1 barrette used between the threshold and Point B;
  - (b) 2 light sources from Point B to Point D; and
  - (c) 3 light sources beyond Point D.
- (15) A barrette must be:
  - (a) at least 4 m in length; and
  - (b) if composed of lights approximating to point sources — composed of such lights uniformly spaced at intervals of not more than 1.5 m.
- (16) If the centreline beyond Point B consists of barrettes as described in subsection (14), each barrette must be supplemented by a sequenced flashing light which must:
  - (a) be flashed twice every second in sequence, beginning with the outermost light of the system and progressing toward the threshold to the innermost light; and
  - (b) be of such electrical circuit design that it can be operated independently of the other lights of the approach lighting system; and
  - (c) have a minimum effective intensity of 15 000 cd  $\pm$  50%.

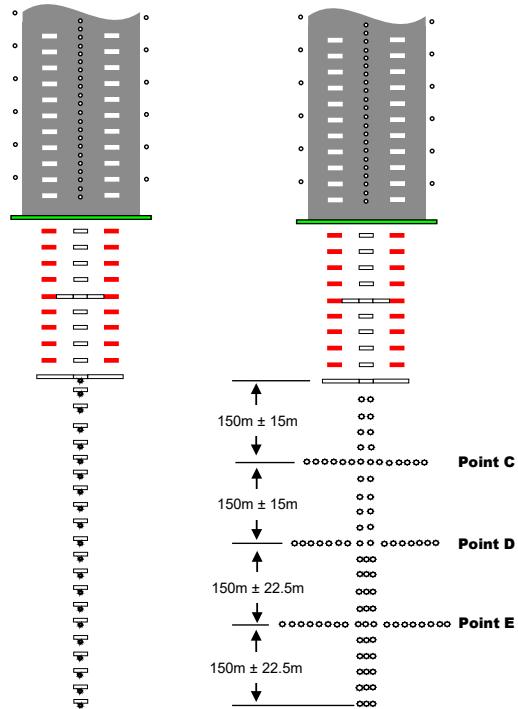
*Note* See FAA *Advisory Circular 150/5345-51*, as in force or existing from time to time and freely available from the FAA website, [www.faa.gov](http://www.faa.gov), for further information.

- (17) Each side row of lights must consist of a barrette:
  - (a) whose lights show red; and
  - (b) whose length and light spacing must be equal to the length and light spacing of the barrettes in the touchdown zone.
- (18) The lights forming the crossbars must be:
  - (a) fixed lights showing variable white light; and
  - (b) uniformly spaced at intervals of not more than 2.7 m.
- (19) For subsections (17) and (18), the intensity of the red lights must be consistent with the intensity of the white lights.
- (20) The light intensities must be in accordance with Figures 9.43 (1)-1 and 9.43 (1)-2.

*Note* For information on the flight path envelopes used in the design of these lights, see ICAO Annex 14, *Aerodromes, Volume 1, Aerodrome Design and Operations, Attachment A, Section 11*. For ICAO documents, see section 1.07.



Inner 300 m approach and runway lighting for precision approach runways, categories II and III



Typical full length configurations for approach lighting systems, categories II or III

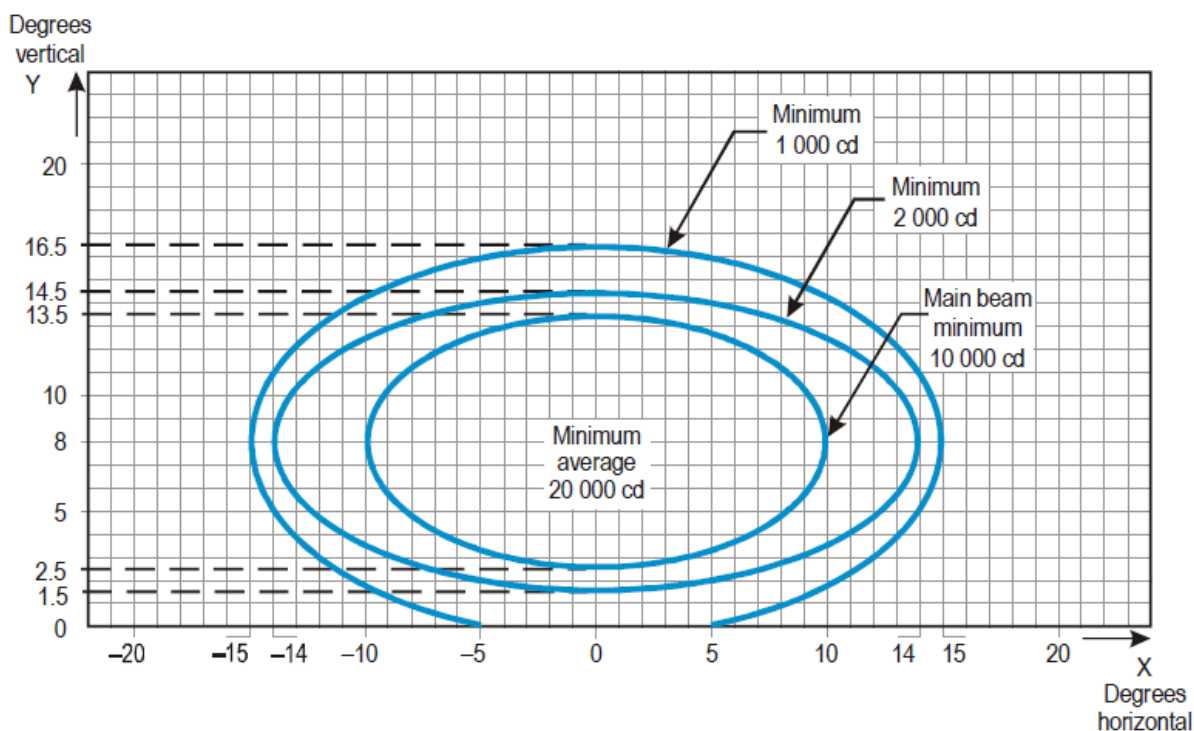
**Figure 9.42 (3) Precision approach CAT II and CAT III lighting systems (shows matters)**

# CHAPTER 9

## Division 8 Isocandela diagrams of approach lighting

### 9.43 Isocandela diagrams of approach lighting

- (1) The ratio between the average light intensities of the following:
  - (a) the ellipse defining the main beam of a typical, newly installed approach light;
  - (b) the main beam of a typical newly installed runway edge light;
 must be as follows:
  - (c) for approach centreline and crossbar lights for a precision approach lighting system — 1.5 to 2.0 (white light), as shown in Figure 9.43 (1)-1;
  - (d) for approach side row lights for a precision approach lighting system — 0.5 to 1.0 (red light) as illustrated in Figure 9.43 (1)-2.
- (2) The average light intensity of the ellipse defining the main beam of a simple approach lighting system (*SALS*) not associated with a precision approach runway must be at least the same as the corresponding runway edge light.



Curves calculated on formula:

$$\frac{x^2}{a^2} + \frac{y^2}{b^2} = 1$$

a	10	14	15
b	5.5	6.5	8.5

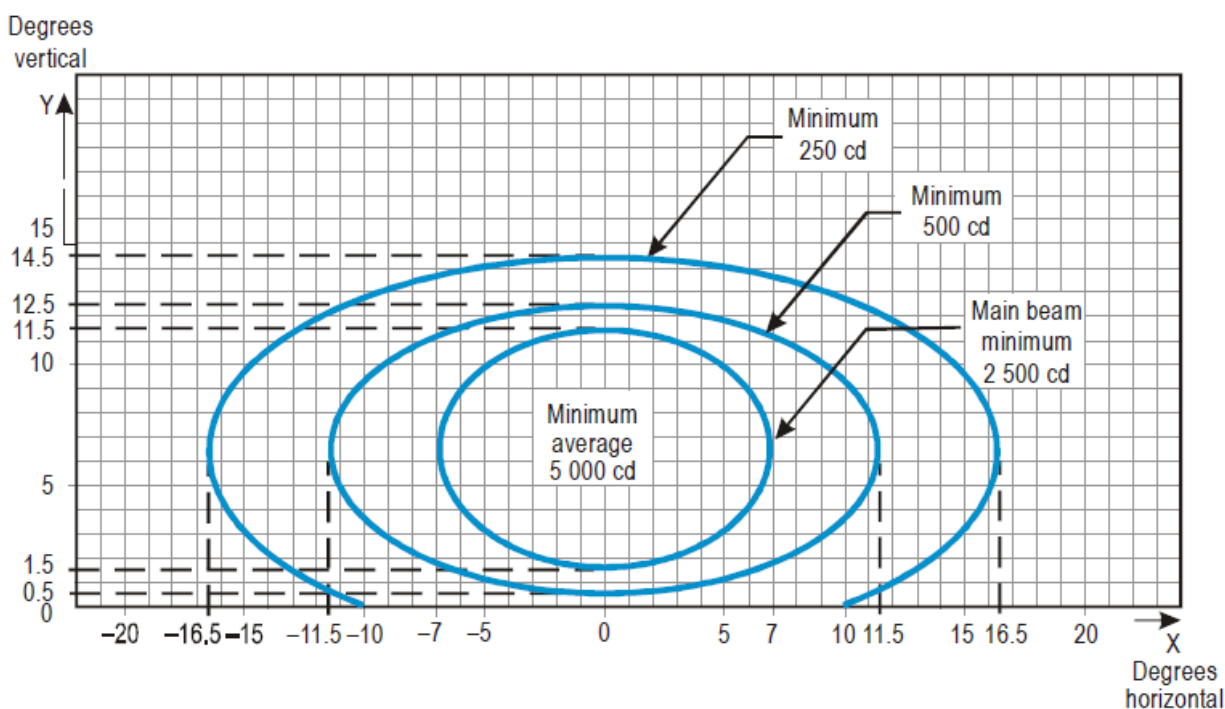
**Figure 9.43 (1)-1 Isocandela diagram for approach centreline and crossbar lights (white light) (shows matters)**

- (3) Vertical setting angles of the approach centreline and crossbar lights must be such that for a distance from the threshold mentioned in a row of column 1 of Table 9.43 (3) the vertical main beam coverage must be the value mentioned in the same row in column 2.

**Table 9.43 (3) Vertical setting angles — approach centreline and crossbar lights**

Distance from threshold	Vertical main beam coverage
Threshold to 315 m	0° – 11°
316 m to 475 m	0.5° – 11.5°
476 m to 640 m	1.5° – 12.5°
641 m and beyond	2.5° – 13.5° (as illustrated above in Figure 9.43 (1)-1)

- (4) Subject to subsections (5) and (7), all lights must be aligned parallel to the centreline of the runway.
- (5) Lights in crossbars beyond 22.5 m from the centreline must be toed-in 2 degrees.



Curves calculated on formula:

$$\frac{x^2}{a^2} + \frac{y^2}{b^2} = 1$$

a	7.0	11.5	16.5
b	5.0	6.0	8.0

**Figure 9.43 (1)-2 Isocandela diagram for approach side row light (red light)**



- (6) Vertical setting angles of the approach side row lights must be such that for a distance from the threshold mentioned in a row of column 1 of Table 9.43 (6), the vertical main beam coverage is the value mentioned in the same row in column 2.

**Table 9.43 (6) Vertical setting angles — approach side row lights**

<b>Distance from threshold</b>	<b>Vertical main beam coverage</b>
Threshold to 115 m	0.5° – 10.5°
116 m to 215 m	1.0° – 11°
216 m and beyond	1.5° – 11.5° (as illustrated above in Figure 9.43 (1)-2)

- (7) Approach side row lights must be toed-in 2 degrees.

## CHAPTER 9

### Division 9 Visual approach slope indicator systems

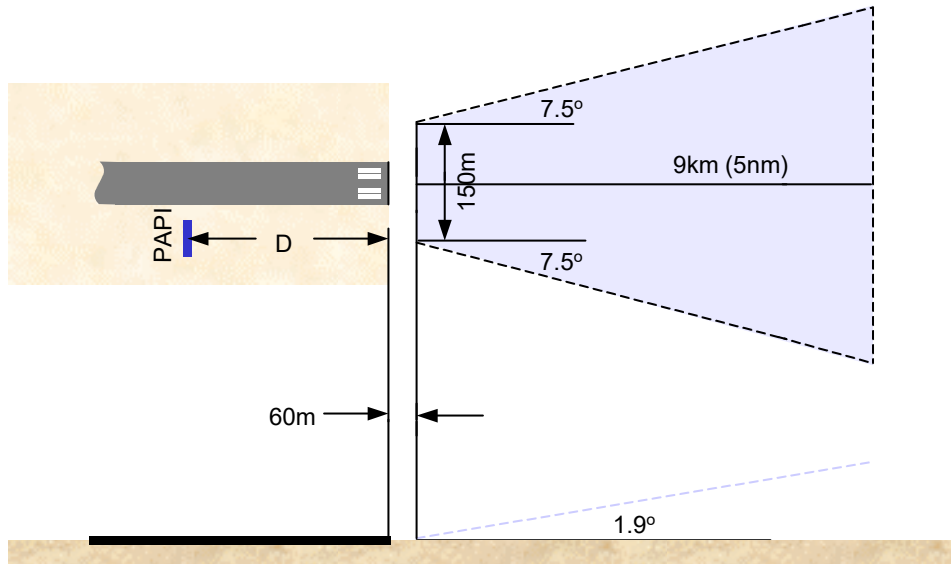
#### 9.44 Visual approach slope indicator systems (VASISs)

- (1) This Division applies to the following types of VASIS:
  - (a) a T visual approach slope indicator system (*T-VASIS*);
  - (b) an abbreviated T visual approach slope indicator system (*AT-VASIS*);
  - (c) a precision approach path indicator system (*PAPI*);
  - (d) a double-sided PAPI.
- (2) The following VASIS must be installed:
  - (a) at an aerodrome with scheduled international air transport operations — a T-VASIS or a double-sided PAPI;
  - (b) at an aerodrome without scheduled international air transport operations — an AT-VASIS or a PAPI, unless CASA has determined, in writing, that additional roll guidance is required;
  - (c) at an aerodrome where CASA has determined that additional roll guidance is required under paragraph (b) — a T-VASIS or a double-sided PAPI;
  - (d) if CASA determines, in writing, that high system integrity is required at an aerodrome — a T-VASIS or a double-sided PAPI.
- (3) If an existing taxiway or physical obstruction makes it impossible to install a T-VASIS or a double-sided PAPI on both sides of the runway, an AT-VASIS or a single-sided PAPI must be installed at the applicable runway threshold.
- (4) If an existing taxiway or physical obstruction makes it impossible to install a T-VASIS or a double-sided PAPI on the left-hand side of the runway to achieve the required threshold clearance based on the nominated approach slope, an AT-VASIS or a single-sided PAPI must be installed on the right-hand side at the applicable runway threshold.
- (5) An AT-VASIS or PAPI must be installed on the left-hand side of the runway (as viewed by a pilot approaching to land on the runway) unless it is physically impossible to so locate it, in which case the location may be on the right-hand side of the runway.
- (6) If more than one type of VASIS is used at an aerodrome, the same type of VASIS must be used at each threshold of a runway to avoid confusion.
- (7) If there is more than one runway, the same type of VASIS must be used on all runways with the same runway code number.
- (8) Subsection (6) does not apply if a VASIS type is provided for temporary use only.

#### 9.45 Obstacle assessment surfaces

- (1) For each threshold of a runway where a VASIS is provided, an obstacle assessment surface (*OAS*) must:
  - (a) be identified from an obstacle survey and assessment; and

- (b) meet the following standards as illustrated in Figure 9.45 (1):
- (i) the baseline must be 150 m wide and coincident with the existing baseline for the approach surface;
  - (ii) the slope must be 1.9°;
  - (iii) the splay must be 7.5° outwards, commencing from the ends of the baseline;
  - (iv) the length must be 9 km measured from the baseline.



**Figure 9.45 (1) Obstacle assessment surface for 3° approach slope (illustrates matters)**

- (2) If an object or structure, for example a radio mast, a building or high terrain, infringes the OAS, the aerodrome operator must apply to CASA for a written determination as to whether the object or structure would adversely affect the safety of aircraft operations.
- (3) Unless CASA determines that the object or structure would not adversely affect the safety of aircraft operations, the operator must take all reasonable steps to:
  - (a) remove the object or structure; or
  - (b) have the entity responsible for the object or structure remove it.
- (4) If it is not possible to remove the object or structure, then the aerodrome operator must:
  - (a) raise the approach slope of the VASIS:
    - (i) for a runway used by jet engine aeroplanes — to a maximum of 3.3°, and also raise the OAS slope by the same amount; or
    - (ii) for a runway used by other aeroplanes — to a maximum of 3.5°, and also raise the OAS slope by the same amount; or
  - (b) reduce the azimuth spread so that the object or structure is outside the confines of the T-VASIS or PAPI beam; or
  - (c) displace the axis of the VASIS and its associated OAS by up to 5°; or
  - (d) displace the threshold; or



- (2) An AT-VASIS must consist of 10 light units arranged on one side of a runway and comprising:
  - (a) a single wing bar of 4 light units; and
  - (b) one longitudinal line of 6 lights, bisecting the wing bar.
- (3) In a T-VASIS and an AT-VASIS, the light units must be constructed and arranged in such a manner that, during an approach, the pilot of an aeroplane will:
  - (a) when above the correct approach slope — see an inverted white “T” pattern comprising the white wing bar lights, and 1, 2 or 3 white “fly-down” lights, the more fly-down lights being visible, the higher the pilot is above the correct approach slope; and
  - (b) when on the correct approach slope — see the line of white wing bar lights; and
  - (c) when below the correct approach slope — see a white “T” pattern comprising the white wing bar lights and 1, 2 or 3 white “fly-up” lights, the more fly-up lights being visible the lower the pilot is below the correct approach slope; and
  - (d) when well below the correct approach slope — see a red “T” pattern with the wing bar lights and the 3 fly-up lights showing red.
- (4) A T-VASIS and an AT-VASIS must be:
  - (a) located so that the light units are as shown in Figure 9.46 (1), subject to the tolerances given in Table 9.47 (5); and
 

*Note* The Figure shows the light unit locations for a T-VASIS; for an AT-VASIS only one side of the mirrored arrangement is present.
  - (b) installed so that the light units forming the wing bars, and the light units forming a fly-down or a fly-up matched pair, appear to the pilot of an approaching aeroplane to be substantially in a horizontal line; and
  - (c) mounted so that the light units are as low as possible; and
  - (d) frangible.

#### 9.47 Characteristics of T-VASIS light units

- (1) A T-VASIS light unit must comply with the following requirements:
  - (a) be suitable for both day and night operations;
  - (b) have a suitable intensity control which allows adjustments to be made:
    - (i) to meet the prevailing conditions; and
    - (ii) to avoid dazzling pilots during approach and landing;
  - (c) be such that the light distribution of the beam of each light unit is fan-shaped, showing light over a wide arc in azimuth in the approach direction;
  - (d) for the wing bar light units — produce:
    - (i) a beam of white light from 1° 54' vertical angle up to 6° vertical angle; and
    - (ii) a beam of red light from 0° to 1° 54' vertical angle or greater, but only so much greater as to provide obstacle clearance;

- (e) for the fly-down light units — produce a beam of white light extending from an elevation of  $6^\circ$  down to approximately the approach slope, where it must have a sharp cut-off;
- (f) for the fly-up light units — produce:
  - (i) a beam of white light from approximately the approach slope down to  $1^\circ 54'$  vertical angle; and
  - (ii) a beam of red light below  $1^\circ 54'$  vertical angle, or greater, but only so much greater as to provide obstacle clearance;
- (g) have colour transition from white to red such that it appears to an observer at a distance of not less than 300 m to occur over a vertical angle of not more than 15 minutes;
- (h) be such that the beam of light produced by each of the VASIS light units must show:
  - (i) both day and night — through an angle of at least  $1^\circ 30'$  above and below the approach slope; and
  - (ii) in azimuth through:
    - (A) not less than  $10^\circ$  by day; and
    - (B) not less than  $15^\circ$  by night;

*Note* CASA recommends an increase in the night azimuth to  $30^\circ$  in line with past practice in Australia.

- (i) immediately below the transition sector mentioned in paragraph (g) — have completely red beam intensity of not less than 15% of the intensity of the completely white beam immediately above the transition sector;
  - (j) for all light units — have effective visual range in clear weather of at least 7.4 km over the angles mentioned in paragraphs (d), (e) and (f);
  - (k) for all light units — be so designed and constructed that contamination from dirt or animal faeces on optically-transmitting or reflecting surfaces does not:
    - (i) interfere with the light signals; or
    - (ii) affect the elevation of the beams; or
    - (iii) affect the contrast between the red and white signals;
  - (l) for all light units — be so designed and constructed as to minimise the probability of the slots in the light housing being wholly or partially blocked by snow or ice (if the relevant climatic conditions are possible).
- (2) The approach slope and elevation settings of light beams must comply with the following:
- (a) an approach slope of  $3^\circ$ ;
  - (b) a pilot eye-height over the threshold of 15 m;
  - (c) if the runway on which a T-VASIS is provided is also equipped with an ILS — the siting and elevation of the light units must be such that the T-VASIS approach slope conforms as closely as possible with the ILS glide path;

*Note* A T-VASIS eye-height over the threshold that is 1 m higher than the ILS glide path has been found to satisfy most aeroplanes.

- (d) the light beams from the corresponding light units on opposite sides of the runway must have the same recognition angle, and the fly-up and fly-down light units of the “T” must appear with uniform steps as the approach slope changes;
  - (e) the elevation of the beams of the wing bar light units on both sides of the runway must be the same;
  - (f) the elevation of the top of the beam of the fly-up light unit nearest to each wing bar, and the bottom of the beam of the fly-down light unit nearest to each wing bar, must be equal and correspond to the approach slope;
  - (g) the cut-off angle of the top of the beams of successive fly-up units must decrease by 5' ( $\pm 1/2'$ ) of arc in angle of elevation at each successive unit away from the wing bar;
  - (h) the cut-in angle of the bottom of the beam of the fly-down light units must increase by 7' ( $\pm 1/2'$ ) of arc in angle of elevation at each successive unit away from the wing bar;
  - (i) the elevation setting of the top of the red light beams of the wing bar and fly-up light units must be such that, during an approach, the pilot of an aeroplane, to whom the wing bar and 3 fly-up units are visible, would clear all objects or structures in the approach area by a safe margin, if any such light did not appear red.
- (3) Light units must be sited at least 15 m from the edge of the runway.
- (4) Light units must be sited at least 15 m from the edge of a taxiway, unless CASA approves otherwise in writing.
- (5) The standard and allowable tolerance mentioned in a row of columns 2 and 3 of Table 9.47 (5) apply to the design, installation and subsequent maintenance of the item mentioned in the same row in column 1.

**Table 9.47 (5) T-VASIS light units — standards and tolerances for design etc.**

Item	Standard	Allowable tolerance
Eye height over threshold	15 m <sup>1,2</sup>	+1 m –3 m
Approach slope <sup>3</sup>	3° (1:19 nominal)	
Distance of longitudinal line of light units from runway edge <sup>4</sup>	30 m	±3 m
Leg light unit spacing	45 m 90 m	±4.5 m ±9 m
Clearance from pavements	15 m <sup>5</sup>	
Alignment of each light unit	Parallel to runway centreline	±1°
Light units in a wing bar Fronts of light units Height of light units	Aligned Aligned	±25 mm ±25 mm
Levelling of light units	Level	To the accuracy of the precision engineer's level. <sup>6</sup>

- (6) For Table 9.47 (5), an item, standard or allowable tolerance with a number attached in superscript is subject to or informed by (as the case requires) the content of whichever of the following items has the same number:
1. When the runway on which a T-VASIS is provided is equipped with an ILS, the siting and elevations of the T-VASIS must be such that the visual approach slope conforms as closely as possible to the glide path of the ILS.
  2. A T-VASIS eye height over threshold 1 m higher than the ILS glide path satisfies most, but not all, aircraft.
  3. The use of a different approach slope is permitted, but only with the prior written approval of CASA.
  4. The edge of the runway is defined as the perpendicular distance from the runway centreline, which is half the nominal width of the runway and ignores sealed shoulders.
  5. There is a minimum clearance between any part of a T-VASIS light unit (but not the foundation slab) and an adjacent runway or taxiway pavement.
  6. This includes end-for-ending the level to ensure no inaccuracy of the instrument.
- (7) The aerodrome operator must ensure that the immediate surround of each light unit is kept free of grass.

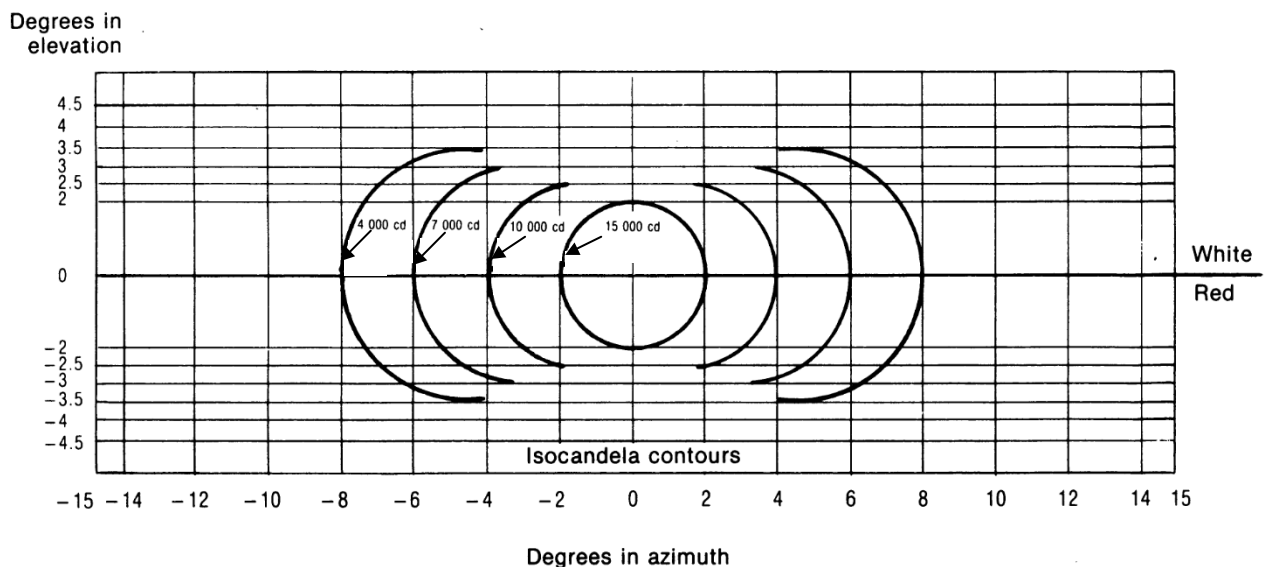
*Note* Tall grass immediately in front of the light unit could provide conflicting light signals. Grass growing near the box on any side could result in the fine settings being disturbed during power mowing operations.

#### 9.48 Precision approach path indicator system (*PAPI*)

- (1) The precision approach path indicator system (a *PAPI*) must consist of a row (a *wing bar*) of 4 equally-spaced sharp transition multi-lamp units or paired single-lamp units.
- (2) Subject to subsection (3), the system must be located on the left-hand side of a runway, as viewed by the pilot of an aircraft approaching to land on the runway.
- (3) If an existing taxiway or physical obstruction makes it impossible to locate the units on the left-hand side of the runway, the PAPI can be placed on the right-hand side of the runway.
- (4) As shown in Figure 9.50 (5), a PAPI must be installed and adjusted so that a pilot making an approach:
  - (a) when on or close to the approach slope — sees the 2 units nearest the runway as red and the 2 units farthest from the runway as white; and
  - (b) when above the approach slope — sees the one unit nearest the runway as red and the 3 units farthest from the runway as white; and
  - (c) when further above the approach slope — sees all the units as white; and
  - (d) when below the approach slope — sees the 3 units nearest the runway as red and the unit farthest from the runway as white; and
  - (e) when further below the approach slope — sees all the units as red.
- (5) A double-sided PAPI must:
  - (a) consist of 8 light units symmetrically disposed about the runway centreline in the form of 2 wing bars of 4 light units each; and
  - (b) be such that the indications seen by the pilot are symmetrical, so that when on or close to the approach slope, the 2 light units nearest the runway, in both wing bars, show red.



- (6) Each PAPI light unit must:
- (a) be suitable for both day and night operations; and
  - (b) have colour transition from red to white in the vertical plane such that it appears to an observer, at a distance of not less than 300 m, to occur within a vertical angle of not more than 3 minutes of arc; and
  - (c) at full intensity, have a red light “y” coordinate not exceeding 0.320; and
  - (d) have a light intensity distribution as shown in Figure 9.48 (6); and
  - (e) have a suitable light intensity control which allows adjustments to be made:
    - (i) to meet the prevailing conditions; and
    - (ii) to avoid dazzling pilots during approach and landing; and
  - (f) be capable of adjustment in elevation so that the lower limit of the white part of the beam may be fixed at any desired angle of elevation between 1°30' and at least 4°30' above the horizontal; and
  - (g) be so designed and constructed that contamination from, for example, deposits of snow, ice, condensation, dirt or animal faeces, on optically-transmitting or reflecting surfaces:
    - (i) interferes to the least possible extent with the light signals; and
    - (ii) does not affect the elevation of the transition sector; and
    - (iii) does not affect the contrast between the red and white signals.



**Figure 9.48 (6) Light intensity distribution of PAPI (shows matters)**

*Note* These curves are for minimum intensities in red light. The intensity value in the white sector of the beam is no less than 2, and may be as high as 6.5, times the corresponding intensity value in the red sector.

### 9.49 Approach slope and elevation setting of light units

The requirements for the approach slope and elevation setting of PAPI light units for a runway are as follows:

- (a) the approach slope, as shown in Figure 9.49, must be appropriate for use by the aeroplanes using the approach;

*Note* The standard approach slope is 3°.

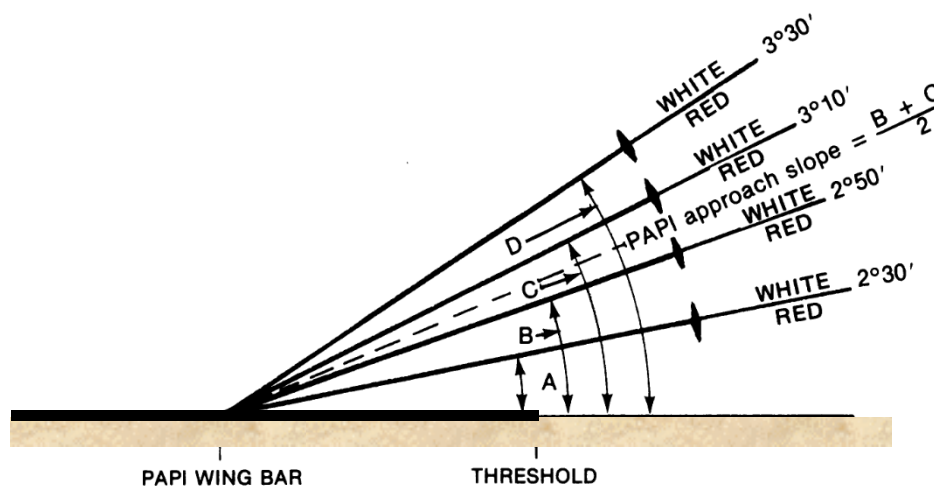
- (b) if the runway is a precision approach runway — the siting and elevation of the light units must be such that the PAPI approach slope conforms as closely as possible with the precision approach glide path;
- (c) for instrument runways with non-precision approaches — the approach slope must conform as closely as possible with the primary instrument approach procedure;
- (d) the angle of elevation settings of the light units in a PAPI wing bar must be such that, during an approach, the pilot of an aeroplane observing a signal of one white light and 3 red lights will clear all objects or structures in the approach area by a safe margin;

*Note* See subsection 9.45 (4) concerning the raising of the approach slope.

- (e) if:
- (i) an object or structure located outside the obstacle assessment surface of the PAPI, but within the lateral limits of its light beam, is found to extend above the plane of the obstacle assessment surface; and
- (ii) an aeronautical study indicates that the object or structure could adversely affect the safety of operations;

then the azimuth spread of the light beam must be restricted so that the object or structure remains outside the confines of the light beam;

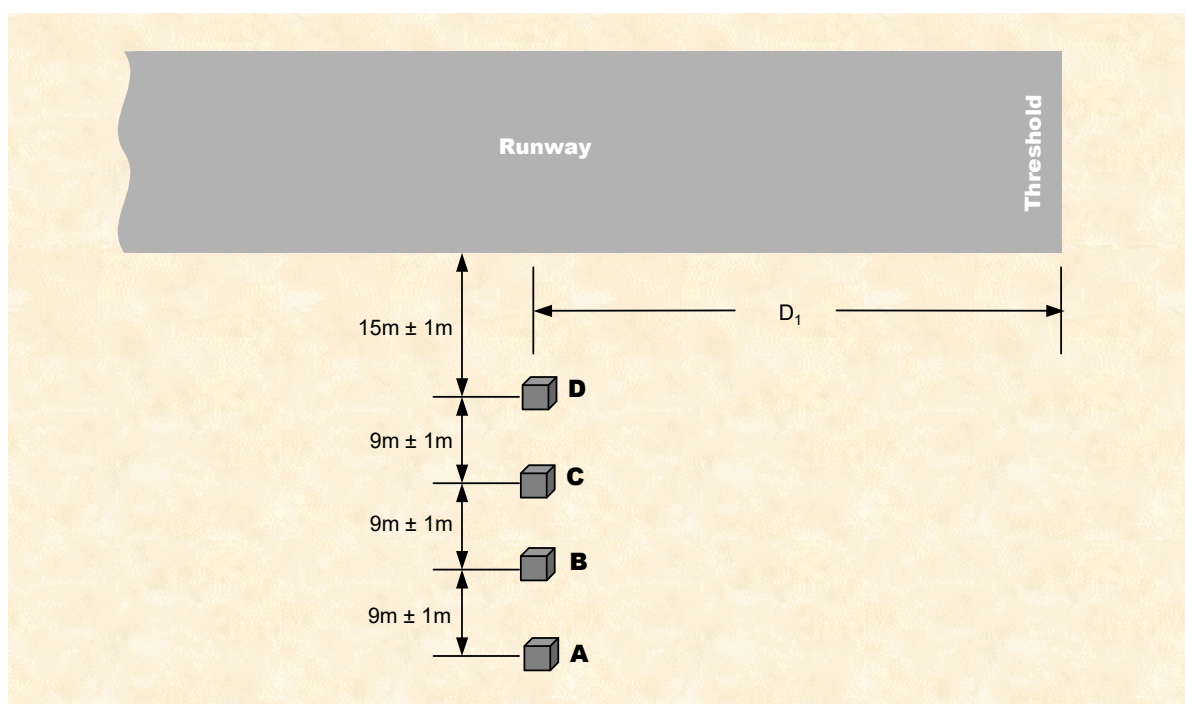
- (f) if a double-sided PAPI is provided, corresponding units on either side of the runway must be seen at the same angle so that the signals of each wing bar change symmetrically and simultaneously.



**Figure 9.49 Light beams and angle of elevation setting for PAPI 3° approach slope (shows matters)**

## 9.50 Siting a PAPI or a double-sided PAPI

- (1) For a PAPI or a double-sided PAPI:
  - (a) the light units forming a wing bar must be frangible, and mounted:
    - (i) as low as possible; and
    - (ii) so as to appear to a pilot of an approaching aeroplane to be substantially in a horizontal line; and
  - (b) the light units must be located:
    - (i) for a PAPI — as shown in Figure 9.50 (1), and subject to the installation tolerances shown in the Figure; and
    - (ii) for a double-sided PAPI — as shown in Figure 9.50 (1):
      - (A) as if the light units A, B, C and D and related dimensions were also shown on the other side of the runway with unit D closest to the runway; and
      - (B) subject to the installation tolerances shown in the Figure.



**Figure 9.50 (1) Siting of PAPI light units (shows matters)**

- (2) If the row of runway edge lights is located beyond the standard 3 m specified in subsection 9.51 (10), then in accordance with subsection 9.51 (11) the PAPI may be located with the inner light unit  $13 \pm 1$  m from the line of the edge lights, rather than  $15 \pm 1$  m from the runway edge.

*Note 1* Reducing the spacing between PAPI light units results in a reduction in the usable range of the system.

*Note 2* When the runway edge lights are relocated to the standard location, CASA recommends that the PAPI should also be relocated to the standard location.

- (3) Subject to subsection (4), the distance ( $D_1$ ) in Figure 9.50 (1), of a PAPI wing bar from the runway threshold, is to be determined by the following:
- (a) the requirement to provide adequate wheel clearance over the threshold for all types of aircraft landing on the runway;
  - (b) the operational requirement that the PAPI is compatible with any non-visual glide path down to the minimum possible range and height;
  - (c) any difference in elevation between the PAPI units and the runway threshold;
  - (d) the remaining length of runway past the touch-down zone available for stopping the aircraft;
  - (e) obstacle clearance.
- (4) In Table 9.50 (4), for the most demanding of the aircraft regularly using the runway, for each of the 4 pilot-eye-to-wheel height groups mentioned in a row of column 1:
- (a) column 2 specifies the standard wheel clearance over the threshold which, subject to paragraph (b), must be used where possible; and
  - (b) column 3 specifies the reduced wheel clearance over the threshold which may be used if:
    - (i) the landing run is limited; and
    - (ii) adherence to the standard wheel clearance would cause a loss of landing distance; and
    - (iii) there are no objects or structures under the approach near the threshold, for example, approach light supporting structures, boundary fences or roads; and
    - (iv) a safety assessment demonstrates that the reduced clearance does not have an adverse effect on aviation safety; and
    - (v) CASA, in writing, approves.

*Note* The standard wheel clearance may be increased if a greater crossing height is considered a safer option compared with a touchdown point further down the runway (subject to adequate landing distance being available for the most demanding aircraft).

**Table 9.50 (4) Wheel clearance over threshold for PAPI**

Pilot-eye-level-to-wheel height of aeroplane in the approach configuration <sup>a</sup>	Standard wheel clearance (metres) <sup>b</sup>	Minimum wheel clearance (metres) <sup>c, d</sup>
Up to but not including 3 m	6	3
3 m up to but not including 5 m	9	4
5 m up to but not including 8 m	9	5
8 m up to but not including 14 m	9	6

The superscript letters in the Table, have the following effect.

- <sup>a</sup> In selecting the pilot-eye-to-wheel height group, only aeroplanes meant to use the system on a regular basis are to be considered. The most demanding of such aeroplanes must determine the pilot-eye-to-wheel height group.
- <sup>b</sup> If possible, the standard wheel clearance shown in column 2 must be provided.
- <sup>c</sup> The wheel clearance may be reduced to not less than those in column 3 with specific written agreement of CASA, where an aeronautical study indicates that such reduced wheel clearances are acceptable.
- <sup>d</sup> If the minimum wheel clearance is provided at a displaced threshold, the corresponding standard wheel clearance specified in column (2) must be available when an aeroplane at the top end of the pilot-eye-to-wheel height group chosen overflies the extremity of the runway.

- (5) The location of the PAPI light units is determined by the relationship between:
  - (a) the approach angle; and
  - (b) the difference in levels between the threshold and the light units; and
  - (c) the minimum eye height over the threshold (**MEHT**), being dependent on the angle  $M$  as shown in Figure 9.50 (5) that is  $2'$  of arc less than the setting angle of the unit which defines the lower boundary of the on-slope indication (unit B, the third unit from the runway as shown in Figure 9.50 (5)).
- (6) If a PAPI is installed on a runway that is not equipped with an ILS, the distance between the threshold and the PAPI ( $D_1$ , shown in Figure 9.50 (5)) must ensure that the lowest height at which a pilot will see a correct approach path indication will provide the wheel clearance over the threshold specified in Table 9.50 (4) for the most demanding of the aeroplanes regularly using the runway.
- (7) If a PAPI is installed on a runway that is equipped with an ILS, the distance between the threshold and the PAPI ( $D_1$ , shown in Figure 9.50 (5)) must ensure the optimum compatibility between the visual and non-visual aids for the range of eye-to-antenna heights of the aeroplanes regularly using the runway.
- (8) If a wheel clearance greater than that specified in subsection 9.50 (4) is required for specific aircraft, this must be achieved by increasing the distance  $D_1$  shown in Figure 9.50 (5).
- (9) The distance  $D_1$  shown in Figure 9.50 (5) must be adjusted to compensate for differences in elevation between the lens centres of the light units and the threshold.
- (10) PAPI units must be no more than 0.9 m above ground level.
- (11) Subject to subsection (12), all units of a wing bar must, as far as possible, lie in the same horizontal plane.
- (12) However:
  - (a) small height differences of no more than 50 mm between light units are permitted if required to allow for any transverse slope; and
  - (b) a lateral gradient not greater than 1.25% is permitted if it is uniformly applied across the units.

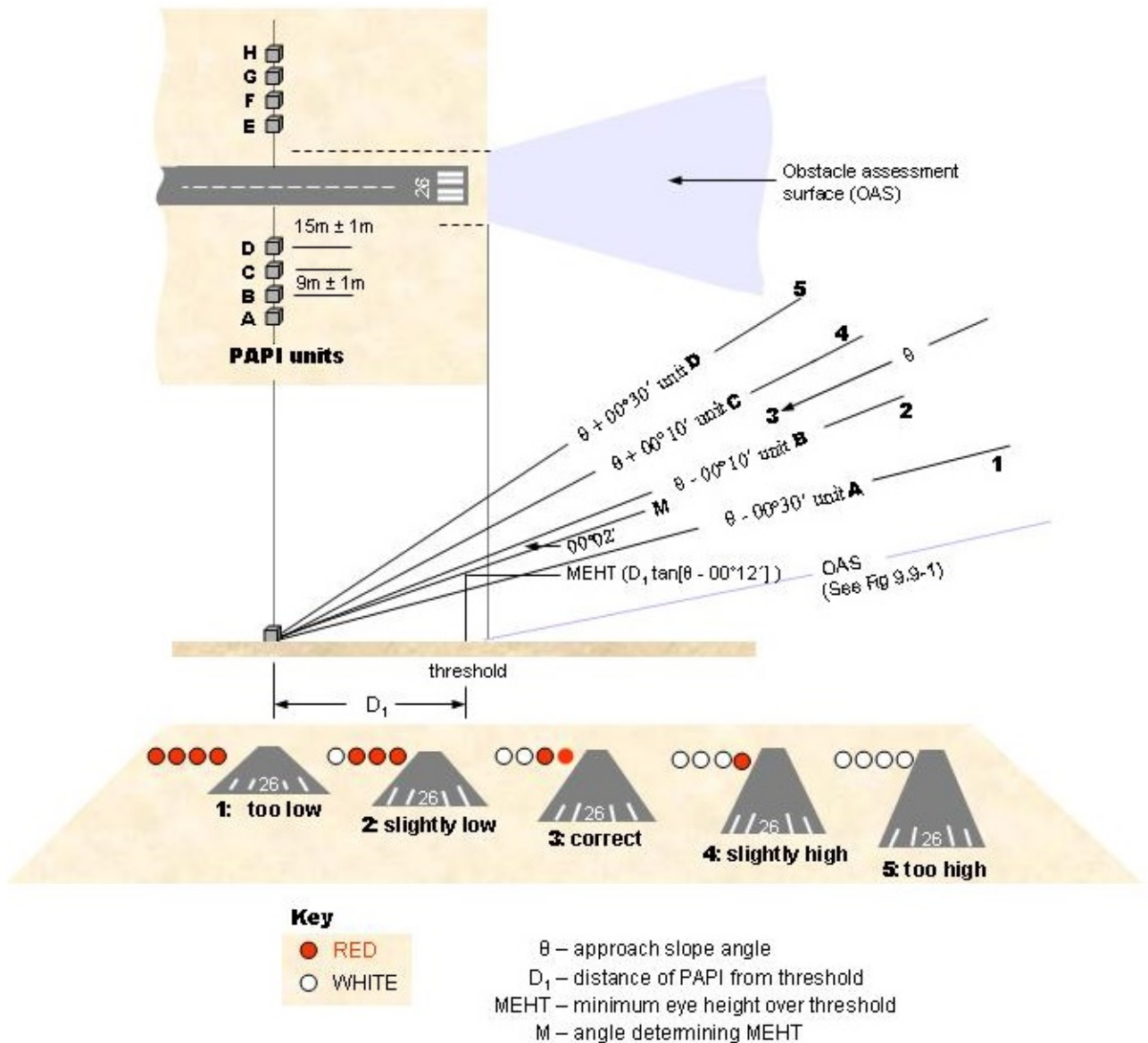


Figure 9.50 (5) The arrangement of a PAPI and the resulting display (shows matters)

## CHAPTER 9

### Division 10 Runway lights

#### 9.51 Runway edge lights

- (1) Runway edge lights must be provided for the following:
  - (a) a non-instrument or non-precision runway intended for use at night;
  - (b) a precision approach runway intended for use by day or night.

*Note* Low-intensity lighting systems will typically form a configuration under paragraph (1) (a), unless a medium-intensity system is required due to environmental factors unique to the aerodrome.
- (2) A runway intended for use at night for any of the following:
  - (a) visual circling;
  - (b) circuits;
  - (c) both visual circling and circuits;must have omnidirectional runway edge lights that comply with the requirements in section 9.52.
- (3) A runway available for take-off operations with an RVR less than 350 m must have runway edge lights that comply with the requirements in section 9.53.
- (4) Runway edge lights must be placed along both sides of a runway so that they:
  - (a) are in 2 parallel straight rows equidistant from the centreline with the pairs of lights opposite each other; and
  - (b) either:
    - (i) for a non-instrument or non-precision approach runway:
      - (A) commence from the threshold and continue to the opposite runway end point; or
      - (B) if the runway edge lights aligned with the threshold are replaced by runway threshold lights that comply with the requirements of subsection 9.55 (2) — commence 1 light space in from the threshold and continue to 1 light space from the opposite runway end point; or

*Note* See optional omnidirectional threshold light units (green) in Figure 9.76 (1).
    - (ii) for a precision approach runway — commence 1 light space in from the threshold and continue to 1 light space from the opposite runway end point.
- (5) The longitudinal spacing of runway edge lights must be uniform and as follows:
  - (a) for an instrument runway — 60 m, but within a tolerance of + 0 m to minus 5 m;
  - (b) for a non-instrument runway — 90 m ± 10 m.

*Note* 60 m + 0 / -5 m is recommended for non-instrument runways if it is intended to upgrade the runway to an instrument runway at some time in the future.
- (6) Despite subsection (5), for the following:
  - (a) a non-instrument runway intersected by another runway or a taxiway;
  - (b) a non-precision instrument runway intersected by another runway or a taxiway;

the runway edge lights at the point of intersection may be:

(c) spaced irregularly; and

(d) omitted;

provided that:

(e) no 2 consecutive lights are omitted; and

(f) any irregular spacing or omission does not significantly alter the visual guidance for a pilot using the runway.

- (7) Runway edge lights must not be omitted on a precision approach runway.
- (8) If a runway edge light cannot be omitted at an intersection, an inset runway edge light must be provided in place of an elevated light.
- (9) Subject to subsection (6), an inset runway edge light must be aligned with the respective edge light on the opposite side of the runway.
- (10) Subject to subsection (11), runway edge lights must be placed:
- (a) along the edges of the area declared for use as the runway in the AIP (the *declared area*); or
  - (b) not more than 3 m outside the edges of the declared area.
- (11) If an aerodrome operator declares, in the AIP, a reduction in the width of a runway, then runway edge lights, located beyond 3 m from the edge of the runway, may remain in place until they are upgraded or replaced, provided that details are recorded in the aerodrome manual and published in the AIP-ERSA.
- (12) For a runway that is less than 30 m wide, the runway edge lights must be placed in accordance with subsection (10) as if the runway were 30 m wide.
- (13) If a runway is provided with circling guidance lights and unidirectional high-intensity runway light units, then:
- (a) the row of unidirectional high-intensity light units must be placed on the inner side, closest to the runway centreline; and
  - (b) the circling guidance lights must be placed on the outer side; and
  - (c) the 2 rows of light units must be:
    - (i) parallel; and
    - (ii) separated by a distance of at least 0.5 m but not more than 3 m.

## **9.52 Characteristics of runway edge lights — non-instrument or non-precision approach runway**

For a non-instrument, or a non-precision, approach runway, the runway edge lights must be lights that:

(a) are fixed; and

(b) are omnidirectional; and

(c) show variable white; and

(d) if elevated — have light distribution that is uniform for the 360° horizontal projection of the light; and



- (e) for a lighting system set at low intensity — have:
  - (i) a minimum light intensity in accordance with that shown in Figure 9.75 (1); and
  - (ii) a main beam which projects light between 1° and 7° above the horizontal at:
    - (A) a minimum average intensity of not less than 100 cd; and
    - (B) a maximum average intensity of not more than 200 cd; and
- (f) for a lighting system set at medium intensity — have:
  - (i) a minimum light intensity in accordance with that shown in Figure 9.75 (2); and
  - (ii) a main beam which projects light between 1° and 7° above the horizontal at:
    - (A) a minimum average intensity of not less than 200 cd; and
    - (B) a maximum average intensity of not more than 600 cd.

### 9.53 Characteristics of runway edge lights — precision approach runway

- (1) For a precision approach runway, the runway edge lights must be lights that:
  - (a) are fixed; and
  - (b) are unidirectional, with the main beam directed towards the threshold; and
  - (c) subject to paragraph (d), show variable white with a minimum light intensity in accordance with that shown in the following Figures in section 9.75:
    - (i) for 30 m to 45 m wide runways — Figure 9.75 (3);
    - (ii) for 60 m wide runways — Figure 9.75 (4); and
  - (d) if located within 600 m from the runway end — show yellow with a minimum light intensity that is 0.4 times the intensity that would be in accordance with that shown in the following Figures in section 9.75:
    - (i) for 30 m to 45 m wide runways — Figure 9.75 (3);
    - (ii) for 60 m wide runways — Figure 9.75 (4); and
  - (e) have a light beam coverage that is toed-in towards the runway as follows:
    - (i) for 30 m to 45 m wide runways — 3.5°;
    - (ii) for 60 m wide runways — 4.5°.
- (2) If omnidirectional circling guidance lights are used in conjunction with subsection (1), they must conform to subsection 9.51 (2).

### 9.54 Runway threshold lights

- (1) For a runway with runway edge lights, runway threshold lights must be provided.
- (2) Runway threshold lights must be located:
  - (a) in a straight line at right angles to the centreline of the runway; and
  - (b) when the threshold is at the extremity of a runway — as near to the extremity as possible and not more than:
    - (i) 3 m outside the extremity; or
    - (ii) 1 m inside the extremity; and

- (c) when the threshold is a displaced threshold — at the displaced threshold with a tolerance of  $\pm 1$  m.

### **9.55 Pattern of runway threshold lights — non-instrument or non-precision approach runway**

- (1) For a non-instrument, or non-precision, approach runway, runway threshold lights must consist of at least 6, equally spaced, unidirectional lights.
- (2) Despite subsection (1), if increased conspicuity of the runway threshold is desired for visual circling or circuit operations, then the runway edge lights, aligned with the threshold position, may be replaced by omnidirectional runway threshold lights on each edge.

*Note* See Figure 9.76 (1) which illustrates the omnidirectional runway threshold lights option (green).

- (3) Runway threshold lights for a non-instrument, or non-precision, approach runway must be inset lights if:
  - (a) the threshold is a permanently-displaced threshold; or
  - (b) it is not possible for elevated lights to be installed.
- (4) For runways with a runway starter extension, the inset threshold lights may be aligned with the runway end light fittings in the reciprocal direction.

### **9.56 Pattern of runway threshold lights — precision approach runway**

For a precision approach runway, runway threshold lights must be spaced at equal intervals of no more than 3 m across the width of the runway.

### **9.57 Characteristics of runway threshold lights — non-instrument or non-precision approach runway**

Runway threshold lights of low intensity or medium intensity must:

- (a) be fixed; and
- (b) be unidirectional; and
- (c) show green in the direction of approach over not less than  $38^\circ$ , and not more than  $180^\circ$ , of azimuth; and
- (d) for the green lights — have an average intensity of the main beam that is 1 to 1.5 times the intensity of the runway edge lights; and
- (e) have a light distribution in the direction of approach that is as close as possible to the light distribution of the runway edge lights; and
- (f) have a minimum light intensity in accordance with that shown in Table 9.75 (2) and Figures 9.75 (1) and 9.75 (2).

### **9.58 Characteristics of runway threshold lights — precision approach runway**

For a precision approach runway, runway threshold lights must:

- (a) be fixed lights; and
- (b) show green in the direction of approach; and
- (c) have a minimum light intensity in accordance with that shown in Figure 9.75 (5).

## 9.59 Additional lighting to enhance threshold location — threshold wing bars and runway threshold identification lights

### Threshold wing bars

- (1) On a precision approach runway, threshold wing bars may be used to increase conspicuousness of the threshold for night operations.
- (2) If used, threshold wing bars must:
  - (a) be fixed, unidirectional lights that, subject to the requirements of any alignment under paragraph (f), are elevated; and
  - (b) show green in the direction of approach; and
  - (c) have a minimum light intensity in accordance with Figure 9.75 (6); and
  - (d) be symmetrically disposed on either side of the threshold; and
  - (e) be at right angles to the runway centreline; and
  - (f) for each wing bar:
    - (i) consist of 5 lights, 2.5 m apart; and
    - (ii) have the innermost light aligned with the row of runway edge lights on the corresponding side of the threshold.

### Runway threshold identification lights (*RTIL*)

- (3) For an aerodrome where it is difficult to locate a runway threshold from the air during the day, runway threshold identification lights (RTIL):
  - (a) must be used with temporarily displaced threshold markings under sections 8.27 and 8.30, and subsection 8.29 (3); and
  - (b) may be used during the day or night in other cases.

*Note* Examples of such difficulty include the case of a displaced threshold, and an aerodrome with a complex runway and taxiway layout in the vicinity of the threshold.
- (4) RTIL:
  - (a) must be used by day — to mark a temporarily displaced threshold of a runway serving scheduled international air transport operations; and
  - (b) may be used by day or night — to mark the temporarily displaced threshold of a runway that is not serving scheduled international air transport operations; and
  - (c) may be used in lieu of temporarily displaced threshold Vee-bar markings required by section 8.29.
- (5) RTIL must conform to the following requirements:
  - (a) 1 light unit must be on each side of the runway, equidistant from the runway centreline, on a line perpendicular to the runway centreline;
  - (b) subject to paragraph (c), the location of the light units must be 12 to 15 m outside each line of runway edge lights, and in line with the threshold;

- (c) if it is not practicable to conform to the location mentioned in paragraph (b) — the light units may be located laterally up to 20 m from the line of runway edge lights and longitudinally up to 12 m before the threshold;
- (d) each light unit must be a minimum of 12 m from the edge of taxiways and runways;
- (e) the elevation of both light units must be within 1 m of a horizontal plane through the runway centreline, with the maximum height above ground not exceeding 1 m.

*Note 1* RTIL may also assist pilot acquisition of a threshold during twilight hours and at night. During these periods, the lights need to be controlled such that an approaching pilot will not be dazzled by the flashing lights.

*Note 2* RTIL are also recommended for temporarily displaced thresholds on runways not serving scheduled international air transport operations.

*Note 3* If RTIL are provided, they should not be used with other strobing lead-in light systems, to avoid conflict. In such cases, CASA recommends that the strobing lead-in light systems are deactivated during the period when the temporary displacement lit with RTIL is in effect.

(6) RTIL must:

- (a) be flashing white lights; and
- (b) be such that the light flashes of each light unit are synchronised, with a normal flash rate of 100 to 120 flashes per minute; and
- (c) have a minimum effective intensity of 15 000 cd  $\pm$  50%; and

*Note* See FAA *Advisory Circular 150/5345-51* as in force or existing from time to time, and freely available from the FAA website, [www.faa.gov](http://www.faa.gov), for further information.

- (d) have the beam axis of each light unit aimed 15° outward from a line parallel to the runway centreline and inclined at an angle of 10° above the horizontal.

*Note* As a guide, runway threshold identification lights should have an acquisition of approximately 7 km in bright sunlight.

## 9.60 Temporarily displaced threshold lights for use at night

If the threshold of a runway is temporarily displaced, temporarily displaced threshold lights must be provided at night to identify the new threshold location.

## 9.61 Location of temporarily displaced threshold lights

For section 9.60, temporarily displaced threshold lights must be provided on each side of the runway:

- (a) in line with the displaced threshold; and
- (b) at right angles to the runway centreline; and
- (c) with the innermost light on each side aligned with the runway edge lights on the corresponding side of the threshold.

## 9.62 Characteristics of temporarily displaced threshold lights

Temporarily displaced threshold lights must conform to the following requirements:

- (a) subject to paragraph (b), an array on each side of the runway must consist of 5 lights;
- (b) for a runway whose width is 30 m or less — each side array may consist of 3 lights instead of 5;

- (c) the lights must be spaced 2.5 m apart;
- (d) for runways with visual circling or circuit operations — the innermost light of each side array may be a fixed, omnidirectional light showing green in all angles of azimuth;
- (e) the outer 4 or 2 lights, as appropriate, of each side array must be fixed, unidirectional lights showing green in the direction of approach over not less than 38°, and not more than 180°, of azimuth;
- (f) the light distribution in the direction of approach must be as close as possible to that of the runway edge lights;
- (g) the light intensity must be as close as possible to 1.5 times that of the runway edge lights but not be less than that of the runway edge lights.

*Note* Temporarily displaced threshold lights are associated only with non-instrument or non-precision instrument approach runway lighting systems. If a precision approach runway has the threshold temporarily displaced, it typically renders ILS unavailable for precision approaches, thus temporarily changing the runway to a non-precision or non-instrument runway. For runways with a GLS, operations are not likely to be affected.

### 9.63 Runway lighting before a displaced threshold

- (1) If part of a runway located before a displaced threshold is available for aircraft use, runway edge lights in that part of the runway must:
  - (a) show red in the direction of approach to the displaced threshold, with a light intensity of not less than one-quarter, and not more than one-half, that of the white runway edge lights; and
  - (b) in the opposite direction, show:
    - (i) white; or
    - (ii) for a precision approach runway — yellow as appropriate; or
    - (iii) for runway edge lights, located within a runway starter extension, which otherwise do not constitute part of a declared stopway — blue.

*Note* Examples of when a runway located before a displaced threshold is available for aircraft use include use for take-offs using a runway starter extension, and landings from the opposite direction.

- (2) For subsection (1), runway edge lights must be:
  - (a) bi-directional light fittings; or
  - (b) separate light fittings installed back to back.
- (3) If the portion of runway before a displaced threshold is closed to aircraft operations, all the runway lights on the portion must be extinguished.

### 9.64 Runway end lights

- (1) For a runway with runway edge lights, runway end lights must be provided.

*Note* See section 6.07 for the required sight distance for runway end lights.

- (2) Runway end lights must be located:
  - (a) in a straight line at right angles to the runway centreline; and
  - (b) if the runway end is at the extremity of the runway — as near as possible to the extremity, and not more than 3 m outside, or 1 m inside, the extremity; and

- (c) if the runway end is not at the extremity of the runway — at the runway end, within a tolerance of  $\pm 1$  m; and
- (d) for each of the following areas:
  - (i) a taxiway for exiting or entering a runway;
  - (ii) a runway turn pad;

in such a way that an aircraft using the area does not cross the row of red runway end lights unless a runway starter extension exists and a runway starter extension light pattern is used.

- (3) For a runway starter extension, the runway end lights aligned with the declared end of the landing distance available must be:
  - (a) in a straight line at right angles to the runway centreline; and
  - (b) located at the declared runway end, within a tolerance of  $\pm 1$  m; and
  - (c) located in such a way that:
    - (i) an aircraft using the extension does not cross the row of red runway end lights, but passes between them when travelling along the runway centreline; and
    - (ii) the minimum width of the passing gap between the runway end lights must be 50% of the distance between the runway edge light rows.
- (4) For a runway starter extension, the end of runway pavement beyond the declared end of the landing distance available must be lit by at least 2 blue taxiway edge lights that are as follows:
  - (a) visible to the pilot using the starter extension before performing a reciprocal turn;
  - (b) not visible to, or shielded from the view of, a pilot on approach to the runway for which the starter extension is provided;
  - (c) aligned with the edge lights of the applicable runway turn pad, runway bypass pad or runway starter extension as set out in section 9.67;
  - (d) for runway widths greater than 30 m — supplemented with 1 additional blue taxiway edge light placed along the extended runway centreline.
- (5) Subject to subsection (6), the runway end lights must consist of:
  - (a) at least 6 lights, spaced at equal intervals between the rows of runway edge lights; or
  - (b) if the runway is provided with the alternative threshold light pattern mentioned in subsection 9.55 (2) — the threshold pattern that is used.
- (6) For a precision approach CAT III runway, the spacing between runway end lights must not exceed 6 m.

### **9.65 Characteristics of non-instrument and non-precision approach runway end lights**

- (1) Runway end lights of low intensity or medium intensity must:
  - (a) be fixed; and
  - (b) be unidirectional; and
  - (c) show red in the direction of the runway over not less than  $38^\circ$ , and not more than  $180^\circ$ , of azimuth; and

- (d) for the red light — have an intensity that is not less than one-quarter, and not more than one-half, that of the runway edge lights; and
  - (e) have a light distribution in the direction of the runway that is as close as possible to that of the runway edge lights; and
  - (f) have a minimum light intensity in accordance with Table 9.75 (2) and Figures 9.75 (1) and 9.75 (2).
- (2) Low-intensity and medium-intensity runway end lights must be inset lights if:
- (a) the runway is equipped with high-intensity runway end lights; or
  - (b) a stopway or runway starter extension is provided beyond the declared runway end; or
  - (c) it is not physically possible for elevated lights to be installed.
- (3) If the runway end coincides with the runway threshold, the following may be used:
- (a) a bi-directional light fitting;
  - (b) separate light fittings, installed back to back.

### **9.66 Characteristics of precision approach runway end lights**

Runway end lights of high intensity must:

- (a) be inset; and
- (b) be fixed; and
- (c) be unidirectional; and
- (d) show red in the direction of the runway; and
- (e) have a minimum light intensity in accordance with Figure 9.75 (7).

### **9.67 Runway turn pad, runway bypass pad and runway starter extension edge lights**

- (1) Where an aircraft turn pad, runway bypass pad or runway starter extension is provided on a runway that has runway edge lights, the edge of the relevant pad or starter extension must be provided with blue edge lights.
- (2) For subsection (1), edge lights must be located not less than 0.6 m, and not more than 1.8 m, outside the edge of the relevant pad or starter extension.
- (3) If the beginning of the splay into a relevant pad or starter extension is more than 10 m from the previous runway edge light, a blue edge light must be located where the pad or extension commences.
- (4) Relevant pad edge lights must be provided to mark any change of direction along the side of the pad.
- (5) If a side of the relevant pad is longer than 30 m, equally-spaced blue edge lights must be provided along that side, with spacing not exceeding 30 m.
- (6) Edge lights required under subsection (1) must have the same characteristics as taxiway edge lights under section 9.93.

## 9.68 Stopway lights

- (1) Stopway lights must be provided on a stopway that is:
  - (a) longer than 180 m; and
  - (b) intended for night use.
- (2) Stopway lights must be located along both sides of the stopway, in line with the runway edge lights, and up to the stopway end.
- (3) The spacing of stopway lights must be uniform and not more than that of the runway edge lights, with the last pair of lights located at the stopway end.
- (4) The stopway end must be further indicated by at least 2 stopway lights at equal intervals across the stopway end between the last pair of stopway lights.
- (5) Stopway lights must:
  - (a) be fixed; and
  - (b) be unidirectional; and
  - (c) show red in the direction of the runway; and
  - (d) not be visible to a pilot approaching to land over the stopway; and
  - (e) have a light distribution in the direction of the runway as close as possible to the light distribution of the runway edge lights; and
  - (f) have a minimum light intensity in accordance with Table 9.75 (2) and Figures 9.75 (1) and 9.75 (2).

## 9.69 Hold short lights

- (1) A runway intended to accommodate land and hold short operations (**LAHSO**) must have hold short lights.
- (2) Hold short lights must:
  - (a) be at least 6 inset lights; and
  - (b) be located across the runway as near to the hold short line as possible; and
  - (c) not be located beyond, and not more than 3 m before, the hold short line; and
  - (d) be at least 75 m from the centreline of the intersecting runway.
- (3) Hold short lights must be:
  - (a) at right angles to the runway; and
  - (b) located symmetrically about the runway centreline; and
  - (c) such that the closest lights to the runway centreline are offset on each side at 1.5 m from the centreline, with subsequent lights spaced at 3 m.
- (4) Hold short lights must:
  - (a) be unidirectional; and
  - (b) show white in the direction of approach to the hold short position; and
  - (c) have photometric characteristics in accordance with Figure 9.75 (8).



- (5) Hold short lights must:
  - (a) flash, in unison, at between 25 and 35 flashes per minute (a *cycle*); and
  - (b) have an illumination period that is approximately 2/3, and a light suppression period that is approximately 1/3, of the total period of each cycle.
- (6) Each bar of hold short lights must be such that the ATC operator controlling a LAHSO operation may individually control, set the intensity of, and monitor the serviceability requirements for, the lights.
- (7) If a secondary power supply is available, hold short lights must be connected to the secondary power supply, with changeover times not greater than for the runway lighting on the same runway.

## 9.70 Runway centreline lights

- (1) Runway centreline lights must be provided on the following:
  - (a) a precision approach CAT II or CAT III runway;
  - (b) a runway intended for take-offs with an operating minimum below an RVR of 350 m.

*Note* Runway centreline lights are also recommended for the following runways if the width between the runway edge lights is greater than 50 m:

- (a) precision approach CAT I runways;
  - (b) runways intended for take-offs with an operating minimum equal to or above an RVR of 350 m.
- (2) Runway centreline lights must be located from the threshold to the runway end at longitudinal spacing of approximately:
    - (a) on a runway intended for use in RVR conditions less than 350 m — 15 m; and
    - (b) on a runway intended for use in RVR conditions of 350 m or greater — 30 m.
  - (3) The runway centreline lights may be offset by not more than 0.6 m from the true runway centreline.
  - (4) For subsection (3), the offset must, as far as possible, be:
    - (a) on the left-hand side of the landing aircraft; or
    - (b) for a runway used in both directions — on the left-hand side of the landing aircraft from the direction from which the majority of landings take place.
  - (5) Runway centreline lights must:
    - (a) be inset, fixed lights; and
    - (b) show white from the threshold to a point 900 m from the runway end; and
    - (c) from 900 m to 300 m from the runway end — have a light pattern of 2 red lights followed by 2 white lights; and
    - (d) for the last 300 m before the runway end — show red.

*Note* The double red and white alternating light arrangement is for interleaving circuitry, to ensure that failure of part of the electrical system does not result in a false indication of the runway distance remaining.
  - (6) For runway centreline lights, the light intensity and distribution must be in accordance with:
    - (a) for lights with 30 m spacing — that shown in Figure 9.75 (8); and
    - (b) for lights with 15 m spacing — that shown in Figure 9.75 (9).

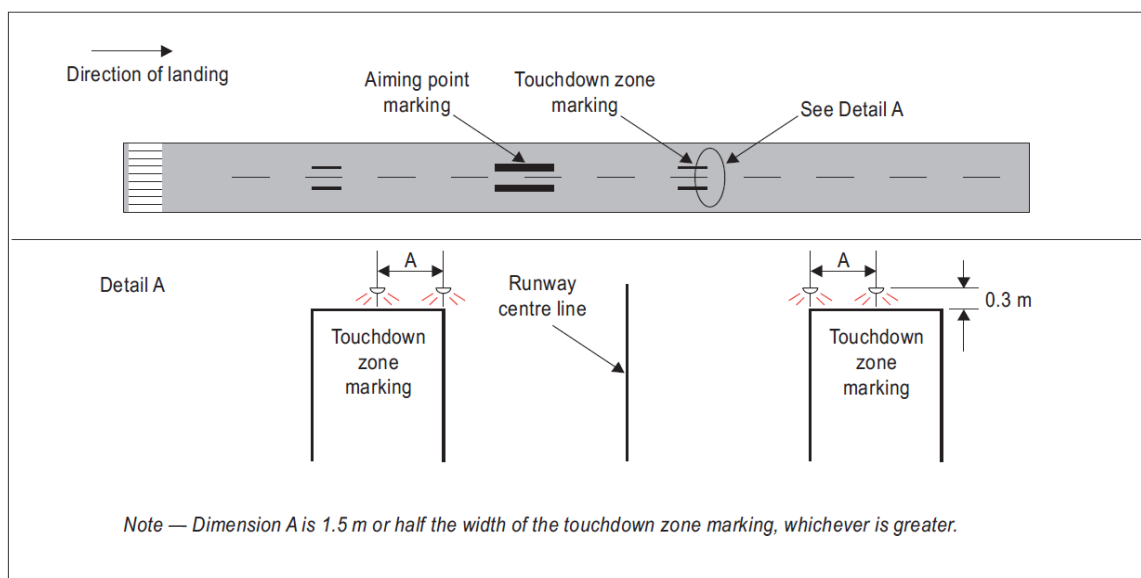
## 9.71 Simple touchdown zone (TDZ) lights

*Note 1* The purpose of simple TDZ lights is to provide pilots with enhanced situational awareness in all visibility conditions and to help enable pilots to decide whether to commence a go-around if the aircraft has not landed by a certain point on the runway. It is essential that pilots operating at aerodromes with simple TDZ lights be familiar with the purpose of these lights.

*Note 2* There is an increased risk of an overrun event occurring at an aerodrome where the approach angle is greater than 3.5 degrees or where a limiting landing distance available combines with other risk factors. CASA recommends the provision of simple TDZ lights where touchdown lights are not otherwise available, in order to enhance situational awareness.

- (1) If provided, simple TDZ lights must comprise 2 pairs of lights with a pair located on each side of the runway centreline 0.3 m beyond the upwind edge of the final TDZ marking, as shown in Figure 9.71 (1).
- (2) The lateral spacing between the inner lights of each pair of lights must be equal to the lateral spacing selected for the TDZ marking.
- (3) The spacing between the lights of the same pair must not be more than the greater of the following:
  - (a) 1.5 m;
  - (b) half the width of the TDZ marking (see Figure 9.71 (1)).
- (4) If provided on a runway without TDZ markings, simple TDZ lights must be installed in a position that provides the equivalent TDZ information.
- (5) Simple TDZ lights must be:
  - (a) fixed unidirectional lights, showing white or variable white; and
  - (b) aligned so as to be visible to the pilot of a landing aeroplane in the direction of approach to the runway.
- (6) For simple TDZ lights, the light intensity and distribution must be in accordance with the specifications shown in Figure 9.75 (10).

*Note* As a good operating practice, CASA recommends that simple TDZ lights should be supplied with power on a separate circuit to other runway lighting so that they may be used when other lighting is switched off.



**Figure 9.71 (1) Simple touchdown zone lights (shows matters)**

## 9.72 Runway TDZ lights

- (1) For a runway intended for precision approach CAT II or CAT III operations, runway TDZ lights must be provided.

*Note* For a precision approach CAT I lighting system, touchdown zone lights may also be provided.

- (2) Runway TDZ lights must:
  - (a) be a series of transverse rows of lights, or barrettes, that are symmetrically located on each side of the runway centreline; and
  - (b) extend for whichever of the following is the lesser:
    - (i) from the runway threshold for a distance of 900 m;
    - (ii) the overall length of the TDZ markings, as described in section 8.24.
- (3) For paragraph (2) (b):
  - (a) each barrette must consist of 3 light units, 1.5 m apart; and
  - (b) the innermost light of each barrette must be located 9 m from the true runway centreline; and
  - (c) the first pair of barrettes must be located 60 m from the threshold; and
  - (d) subsequent barrettes must be spaced longitudinally 60 m apart.
- (5) Runway TDZ lights must be inset, fixed, unidirectional lights, showing variable white.
- (6) For runway TDZ lights, the light intensity and distribution must be in accordance with Figure 9.75 (10).

## 9.73 Photometric characteristics of runway lights and calculation method

- (1) Figure 9.75 (11) shows the method that must be followed to establish the grid points for calculating the average intensity of runway lights for non-instrument and instrument non-precision approach runways.
- (2) Figure 9.75 (12) shows the method that must be followed to establish grid points for calculating the average intensity of runway lights for precision approach runways.
- (3) The average light intensity of the main beam of a runway light is calculated by:
  - (a) establishing the grid points; and
  - (b) measuring the light intensity values at all grid points within, and on, the perimeter of the rectangle or ellipse representing the main beam; and
  - (c) calculating the arithmetic average of the light intensity values as measured at the grid points.
- (4) The maximum light intensity value measured on, or within, the perimeter of the main beam must not be more than 3 times the minimum light intensity value so measured.

## 9.74 Installation and aiming of light fittings

The installation and aiming of light fittings must comply with the following requirements:

- (a) the lights must be installed so that there is no deviation in the main beam pattern that is greater than 0.5 degrees from the applicable standard specified in section 9.75;

- (b) horizontal angles must be measured with respect to the vertical plane through the runway centreline;
- (c) for the measurement of horizontal angles for lights other than runway centreline lights, the direction towards the runway centreline must be taken to be positive;
- (d) vertical angles must be measured with respect to the horizontal plane.

### 9.75 Isocandela diagrams of runway lighting

(1) For this section:

- (a) Figures 9.75 (1) to 9.75 (10) show the minimum allowable light intensities for runway lighting; and
- (b) the boundaries (normally ellipses) in each Figure are symmetrical about the common vertical and horizontal axes; and
- (c) the average light intensity of a runway light main beam must be calculated by:
  - (i) establishing the grid points as shown in Figure 9.75 (11) or 9.75 (12), as the case requires; and
  - (ii) using the intensity values measured at all grid points located within, and on, the boundary (normally an ellipse) representing the main beam; and
  - (iii) using the arithmetic average of the light intensities measured at all considered grid points as the average value.

(2) The ratio between:

- (a) the average light intensity within the boundary (normally an ellipse) defining the main beam of a typical new light of a kind mentioned in a row in column 2 of Table 9.75 (2); and

- (b) the average light intensity of the main beam of a new runway edge light;

must be that given in the same row in column 3, as shown in the Figure mentioned in the same row in column 1.

**Table 9.75 (2) Average main beam light intensity ratios**

Relevant figure for light intensity	Lights	Light intensity ratios
Figure 9.75 (1)	Low-intensity runway edge lights	1.0 (white light)
Figure 9.75 (2)	Medium-intensity runway edge lights	1.0 (white light)
Figure 9.75 (3)	High-intensity runway edge lights (if the width of runway is 30-45 m)	1.0 (white light)
Figure 9.75 (4)	High-intensity runway edge lights (if the width of runway is 60 m)	1.0 (white light)
Figure 9.75 (1)	Low and medium-intensity threshold lights	1.0 to 1.5 (green light)
Figure 9.75 (5)	High-intensity threshold lights	1.0 to 1.5 (green light)
Figure 9.75 (6)	High-intensity threshold wing bar lights	1.0 to 1.5 (green light)

<b>Relevant figure for light intensity</b>	<b>Lights</b>	<b>Light intensity ratios</b>
Figure 9.75 (1)	Low and medium-intensity runway end lights Stopway lights Runway starter extension pre-threshold lights (red)	0.25 to 0.5 (red light)
Figure 9.75 (7)	High-intensity runway end lights	0.25 to 0.5 (red light)
Figure 9.75 (8)	High-intensity runway centreline lights (longitudinal spacing 30 m)	0.5 to 1.0 (white light)
Figure 9.75 (9)	High-intensity runway centreline lights (longitudinal spacing 15 m)	0.5 to 1.0 for CAT III (white light) 0.25 to 0.5 for CAT I, CAT II (white light)
Figure 9.75 (10)	Runway touchdown zone lights	0.5 to 1.0 (white light)

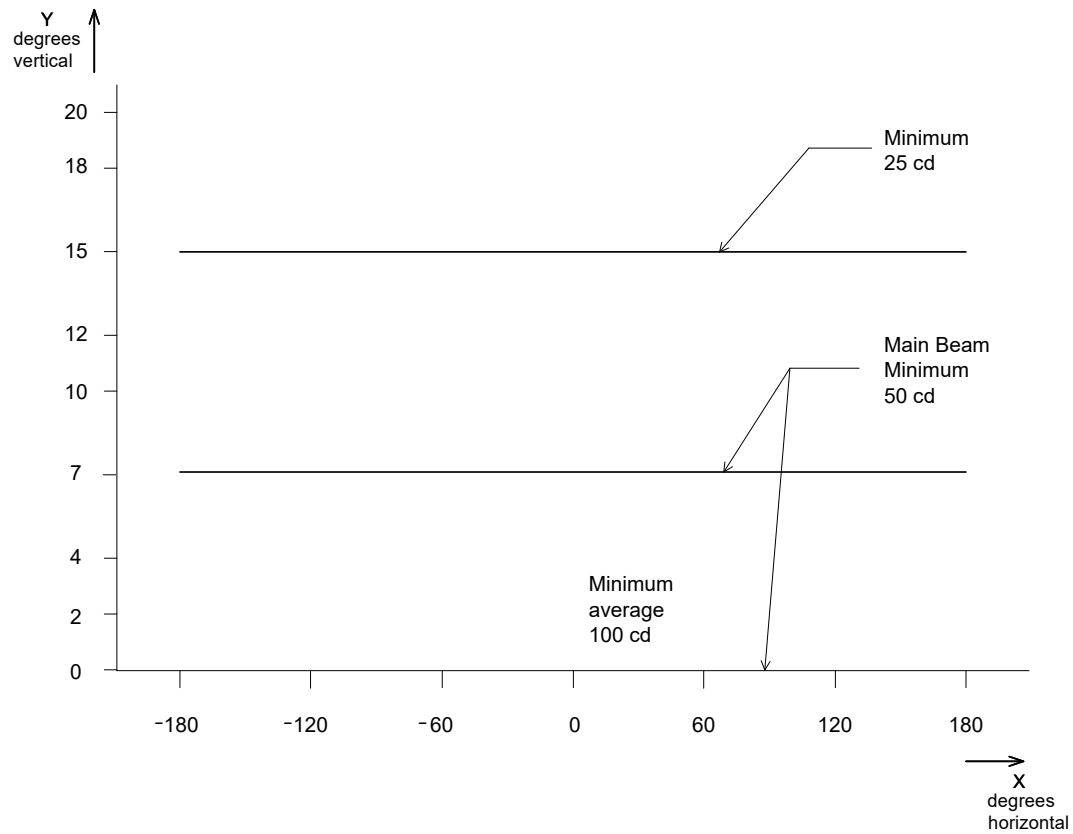
*Note* The beam coverages in the Figures mentioned in Table 9.75 (2) provide the necessary guidance for approaches down to an RVR of 150 m and take-off to an RVR of 100 m.

- (3) For this section:
- (a) horizontal angles are measured with respect to the vertical plane through the runway centreline; and
  - (b) for lights other than centreline lights — the direction towards the runway centreline is considered positive.

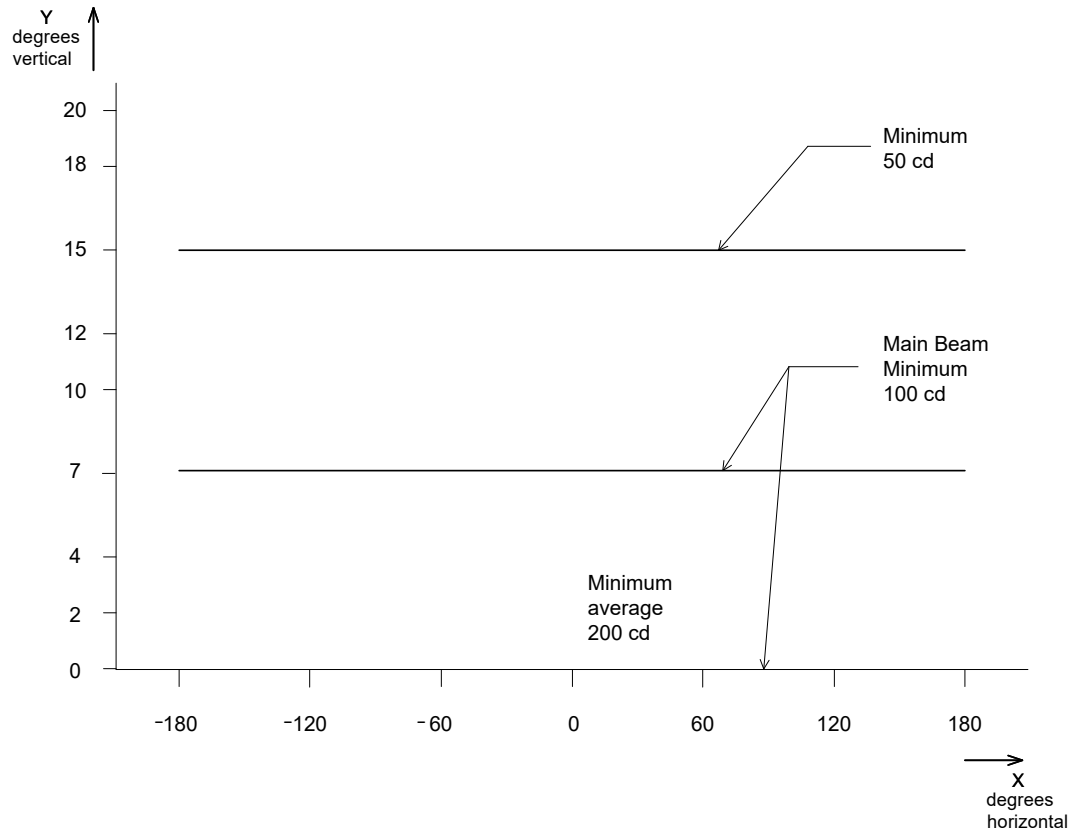
- (4) Vertical angles must be measured with respect to the horizontal plane.

*Note* The vertical minimum values at 0 degrees in Figures 9.75 (1) to 9.75 (12) are depicted for completeness. Values at a 0 degree angle are not intended to restrict the compliance of fittings as a pilot is not intended to see such an angle in proximity to a fitting due to his or her eye height and the cockpit cut-off angle. If a fitting would otherwise not comply with the values established at 0 degrees, a reassessment is permissible for values at 1 degree vertical and above. Values at a vertical angle of less than 1 degree are excluded from consideration.

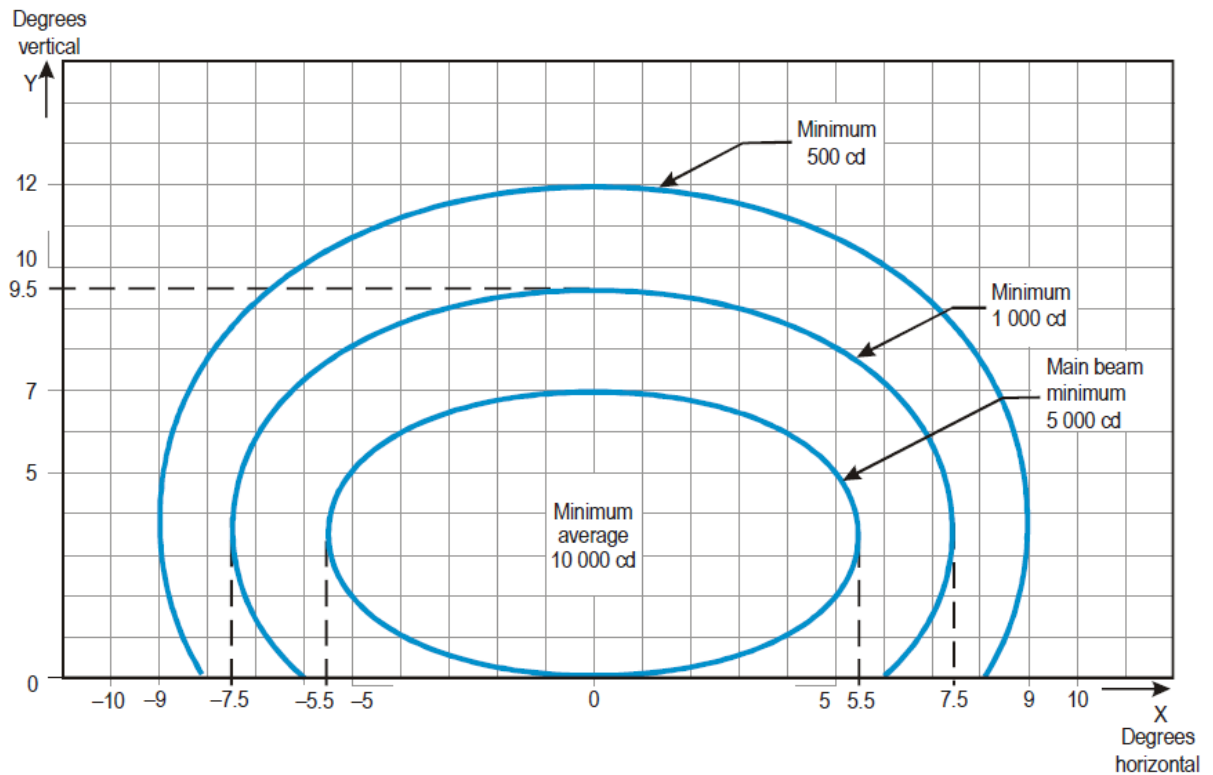
- (5) The maximum light intensity value measured on, or within, the boundary (normally an ellipse) defining the main beam must not be more than 3 times the minimum light intensity value so measured.



**Figure 9.75 (1) Isocandela diagram for omnidirectional runway edge lights for a low-intensity runway lighting system (shows matters)**



**Figure 9.75 (2) Isocandela diagram for omnidirectional runway edge lights for a medium-intensity runway lighting system (shows matters)**

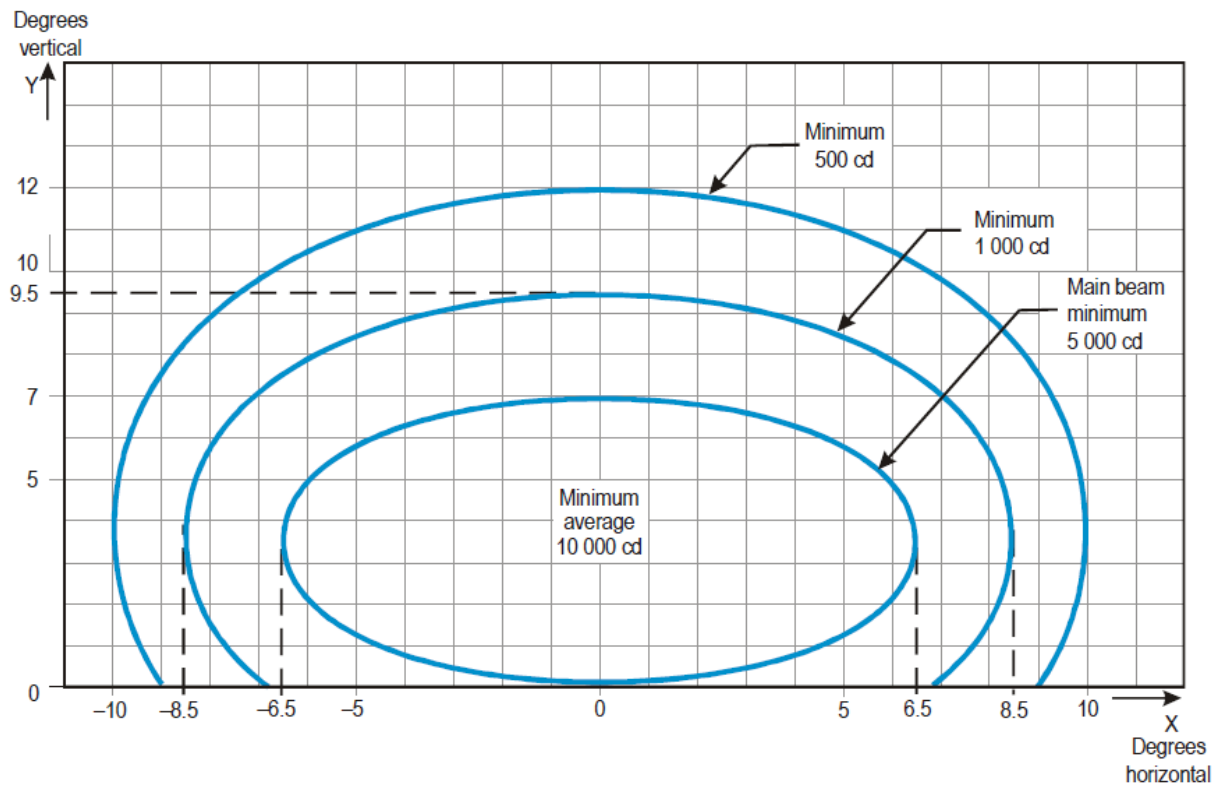


1. Curves calculated on formula  $\frac{x^2}{a^2} + \frac{y^2}{b^2} = 1$

a	5.5	7.5	9.0
b	3.5	6.0	8.5

2. Toe-in 3.5°
3. For red light multiply values by 0.15
4. For yellow light multiply values by 0.4

**Figure 9.75 (3) Isocandela diagram for high-intensity runway edge lights where the width of the runway is 30 to 45 m (white light) (shows matters)**



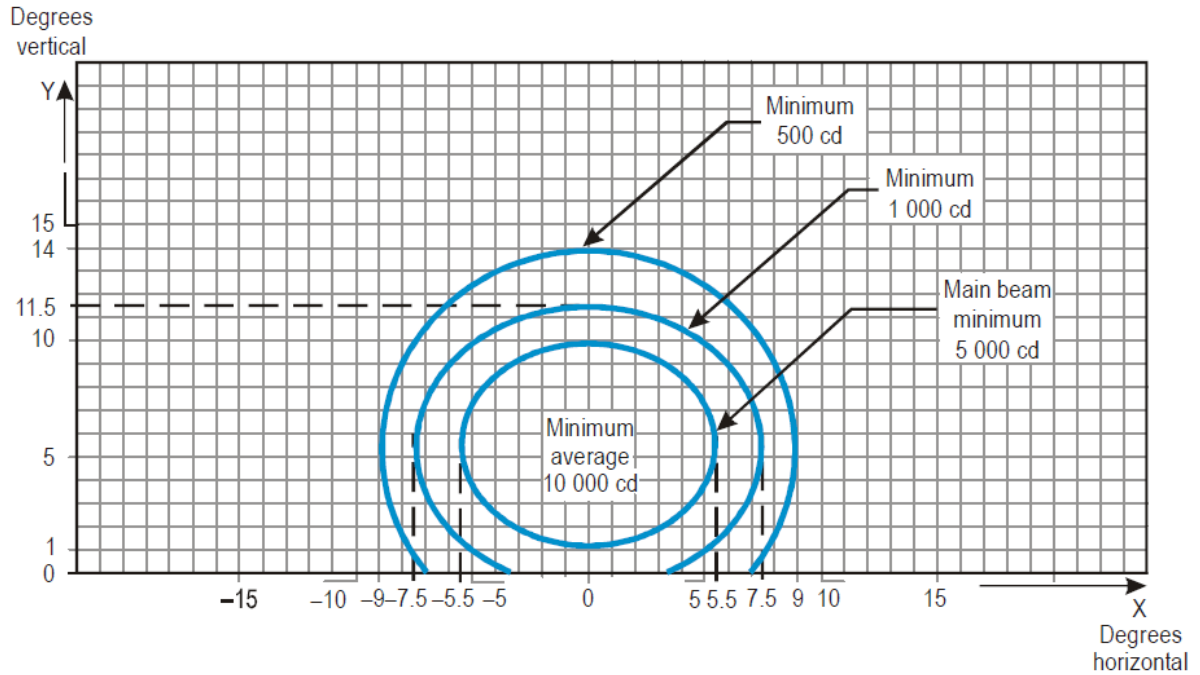
1. Curves calculated on formula  $\frac{x^2}{a^2} + \frac{y^2}{b^2} = 1$

a	6.5	8.5	10.0
b	3.5	6.0	8.5

2. Toe-in 4.5°
3. For yellow light multiply values by 0.4

**Figure 9.75 (4) Isocandela diagram for high-intensity runway edge lights where the width of the runway is 60 m (white light) (shows matters)**



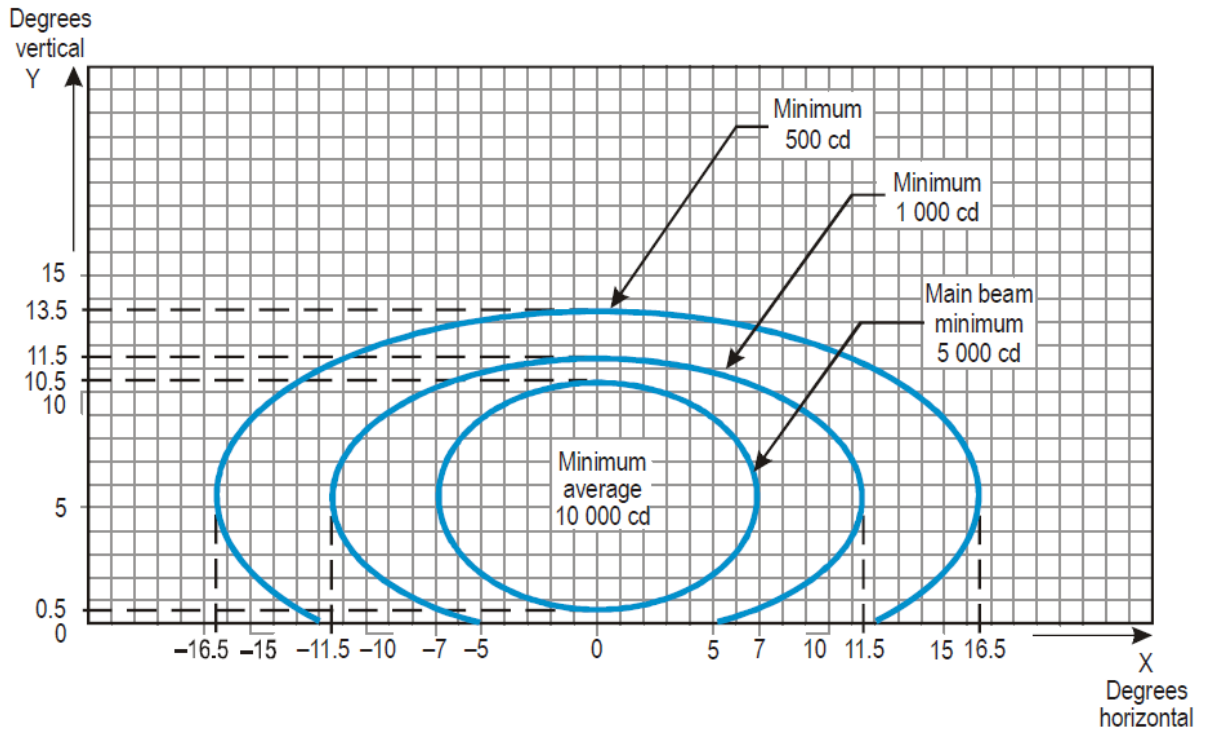


- Curves calculated on formula  $\frac{x^2}{a^2} + \frac{y^2}{b^2} = 1$

a	5.5	7.5	9.0
b	4.5	6.0	8.5

- Toe-in 3.5°

**Figure 9.75 (5) Isocandela diagram for high-intensity threshold lights (green light) (shows matters)**

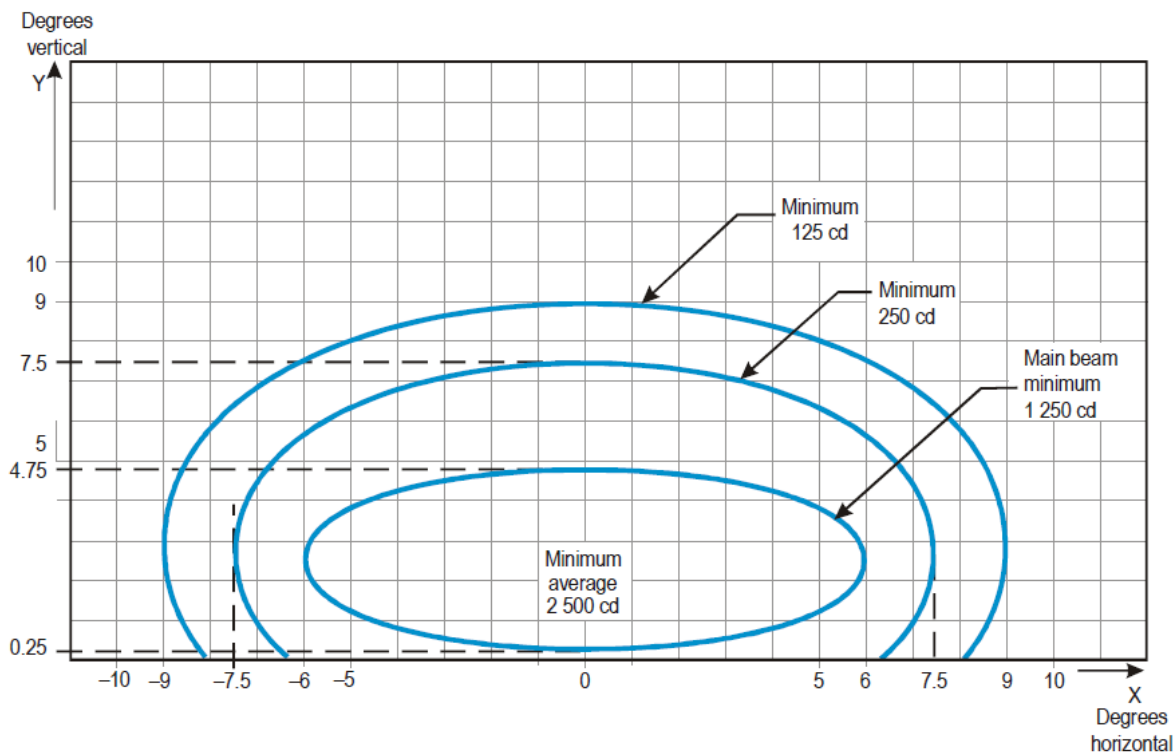


- Curves calculated on formula  $\frac{x^2}{a^2} + \frac{y^2}{b^2} = 1$

a	7.0	11.5	16.5
b	5.0	6.0	8.0

- Toe-in 2°

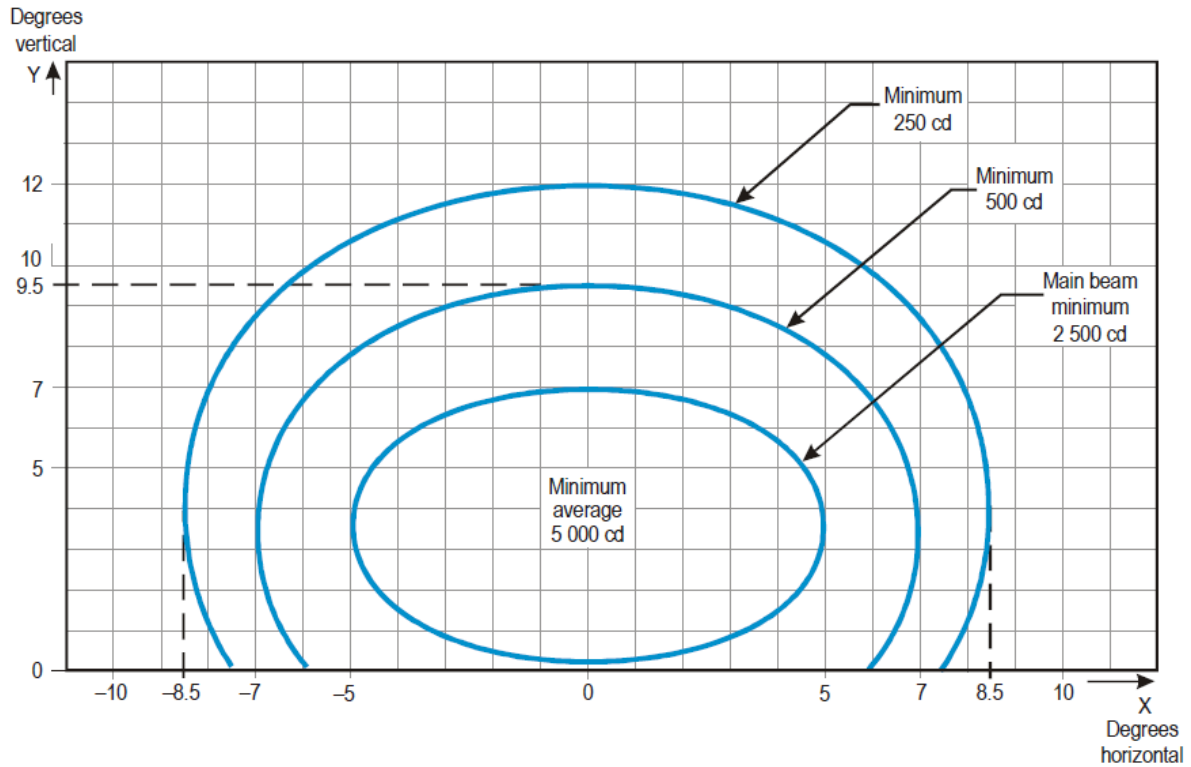
**Figure 9.75 (6) Isocandela diagram for high-intensity threshold wing bar lights (green light) (shows matters)**



1. Curves calculated on formula  $\frac{x^2}{a^2} + \frac{y^2}{b^2} = 1$

a	6.0	7.5	9.0
b	2.25	5.0	6.5

**Figure 9.75 (7) Isocandela diagram for high-intensity runway end lights (red light) (shows matters)**

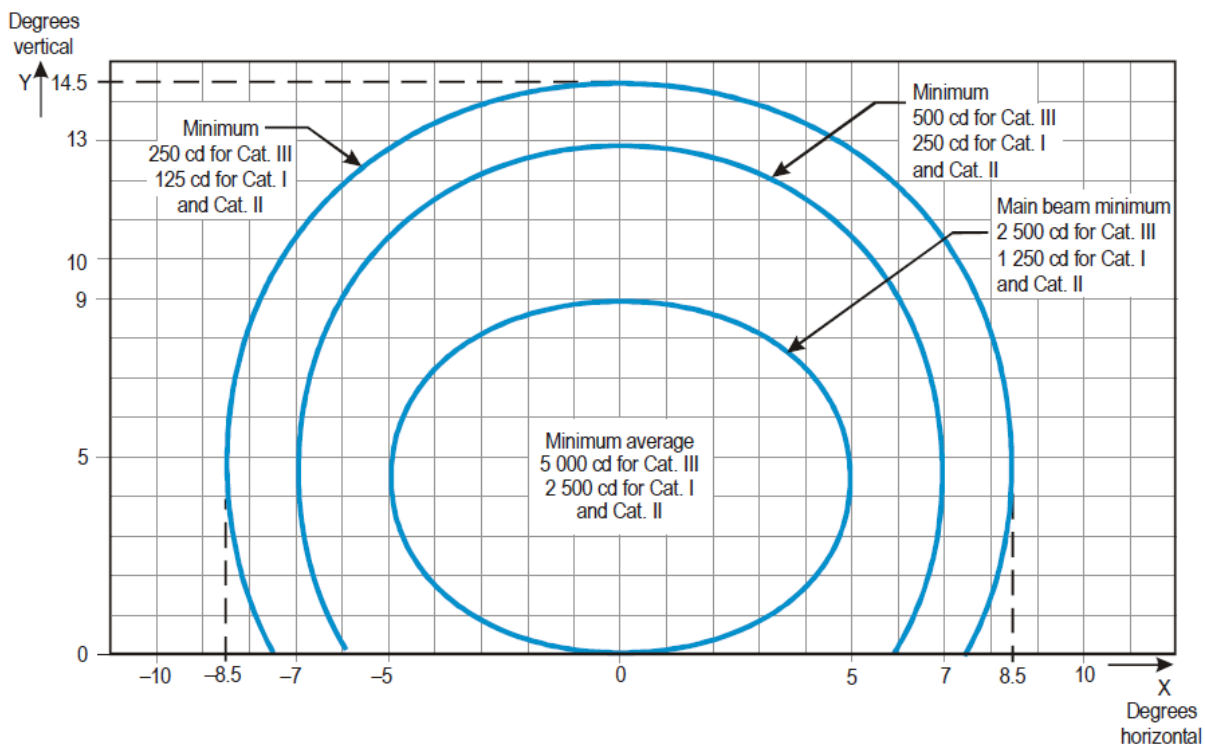


1. Curves calculated on formula  $\frac{x^2}{a^2} + \frac{y^2}{b^2} = 1$

a	5.0	7.0	8.5
b	3.5	6.0	8.5

2. For red light multiply values by 0.15
3. For yellow light multiply values by 0.40

**Figure 9.75 (8) Isocandela diagram for hold short lights, high-intensity runway centreline lights with 30 m longitudinal spacing (white light) and rapid exit taxiway indicator lights (yellow light) (shows matters)**

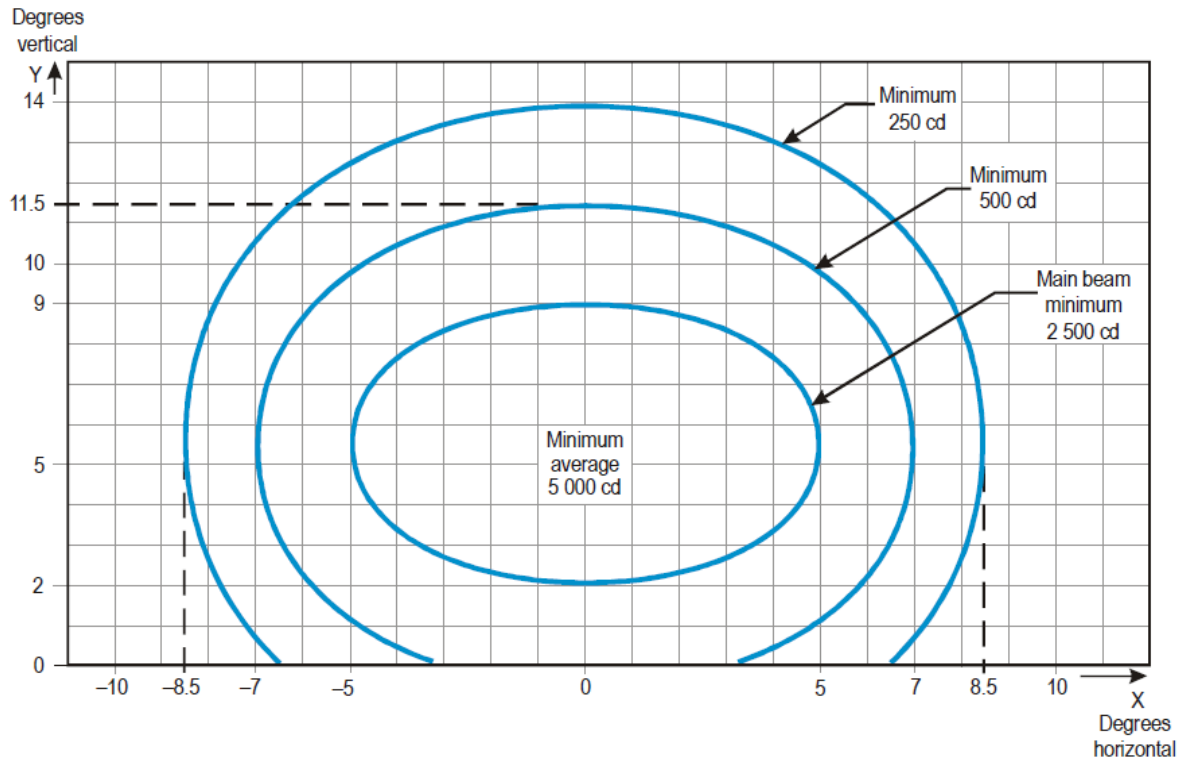


1. Curves calculated on formula  $\frac{x^2}{a^2} + \frac{y^2}{b^2} = 1$

a	5.0	7.0	8.5
b	4.5	8.5	10

2. For red light multiply values by 0.15
3. For yellow light multiply values by 0.40

**Figure 9.75 (9) Isocandela diagram for high-intensity runway centreline lights with 15 m longitudinal spacing (white light) and rapid exit taxiway indicator lights (yellow light) (shows matters)**

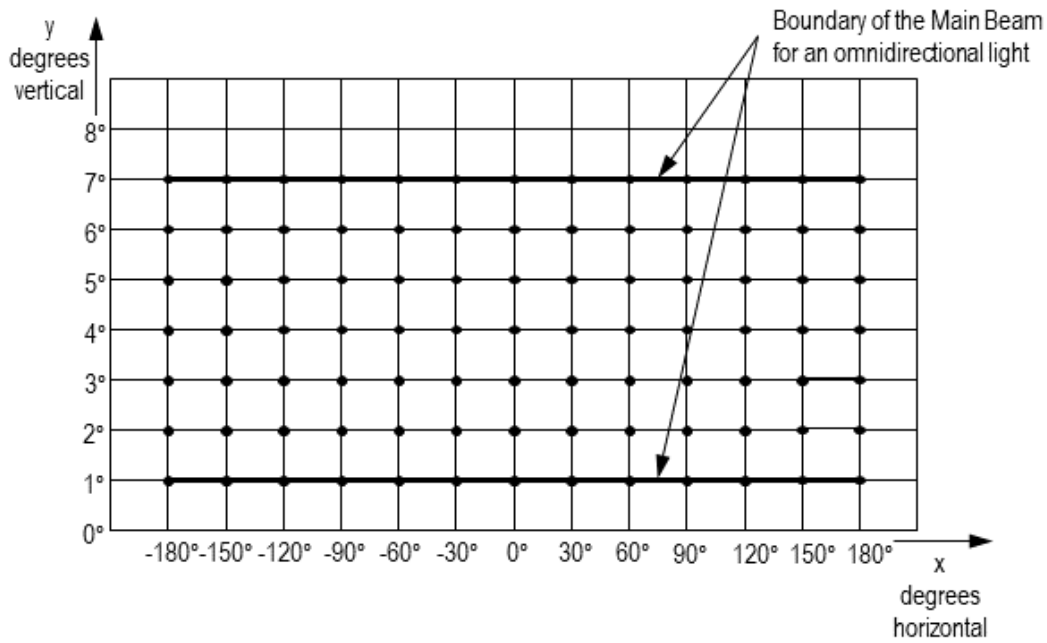


1. Curves calculated on formula  $\frac{x^2}{a^2} + \frac{y^2}{b^2} = 1$

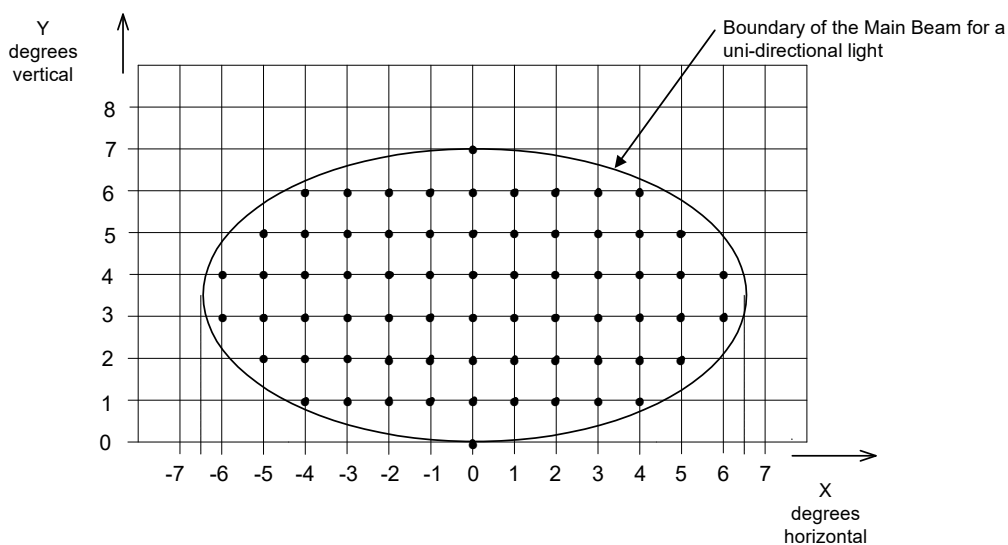
a	5.0	7.0	8.5
b	3.5	6.0	8.5

2. Toe-in 4°

**Figure 9.75 (10) Isocandela diagram for runway touchdown zone lights (white light) (shows matters)**



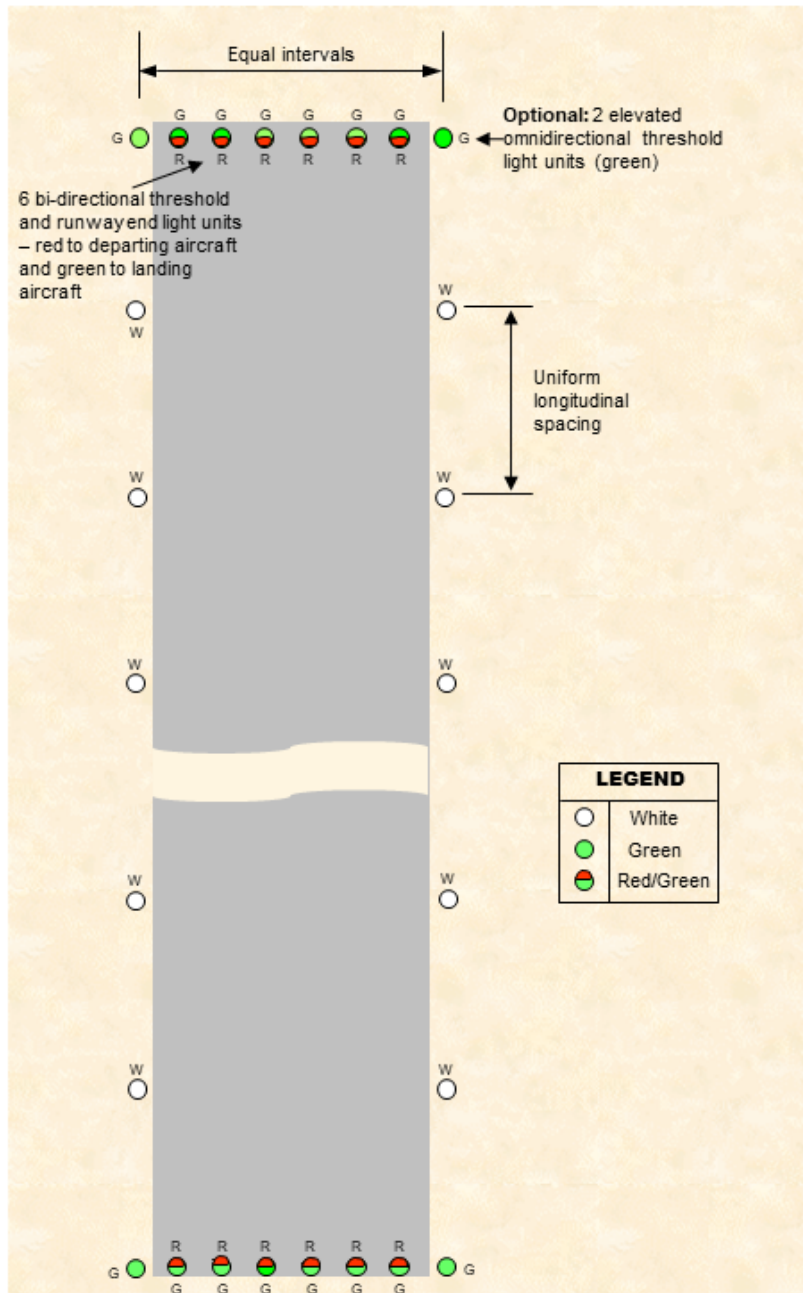
**Figure 9.75 (11) Method of establishing grid points to be used for the calculation of average intensity of runway lights specified by Figures 9.75 (1) and 9.75 (2) (shows matters)**



**Figure 9.75 (12) Method of establishing grid points to be used for the calculation of average intensity of runway lights specified by Figures 9.75 (3) to 9.75 (10) (shows matters)**

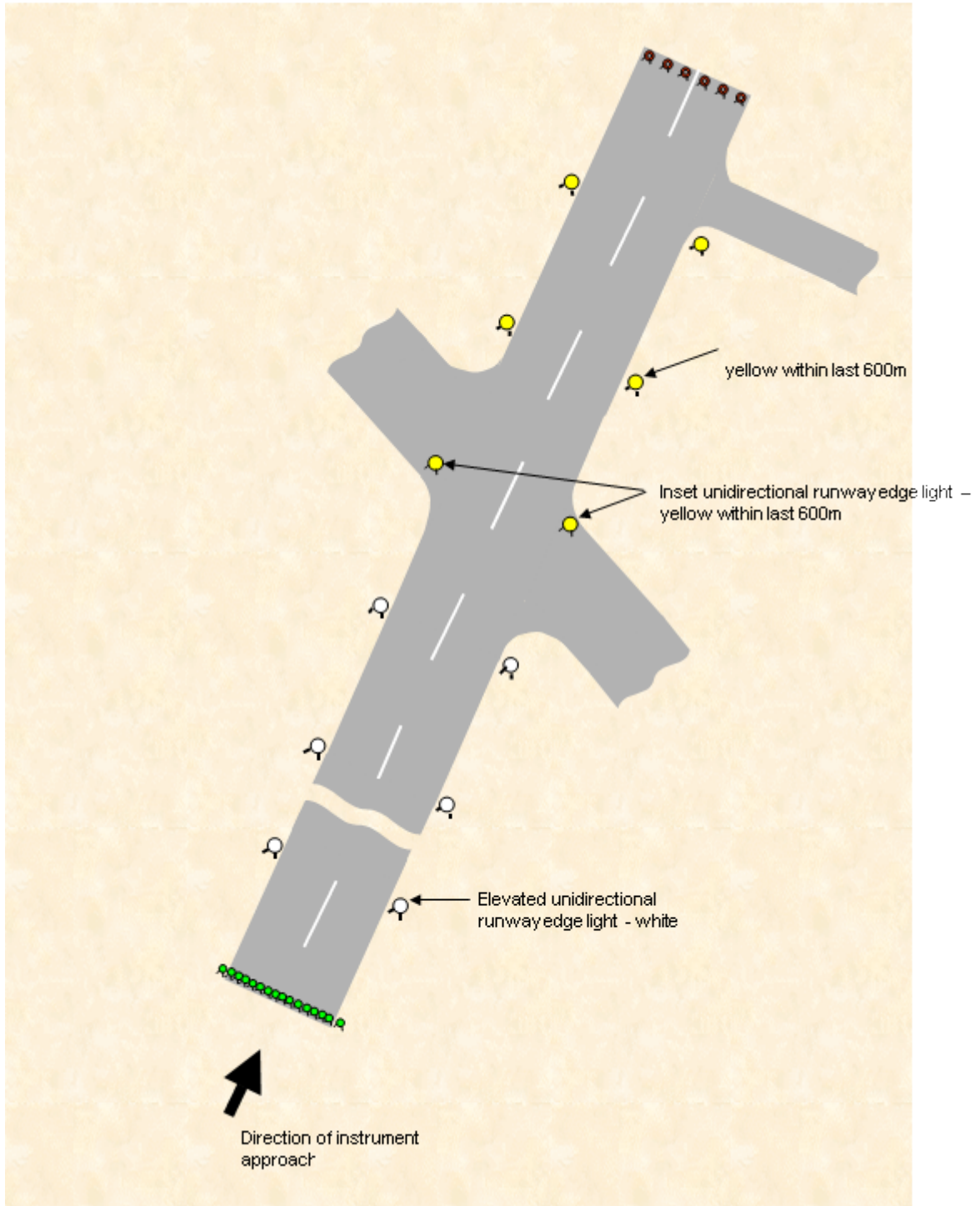
### 9.76 Illustrations of runway lighting

The Figures in this section illustrate matters for runway lighting for the purposes of this Division.

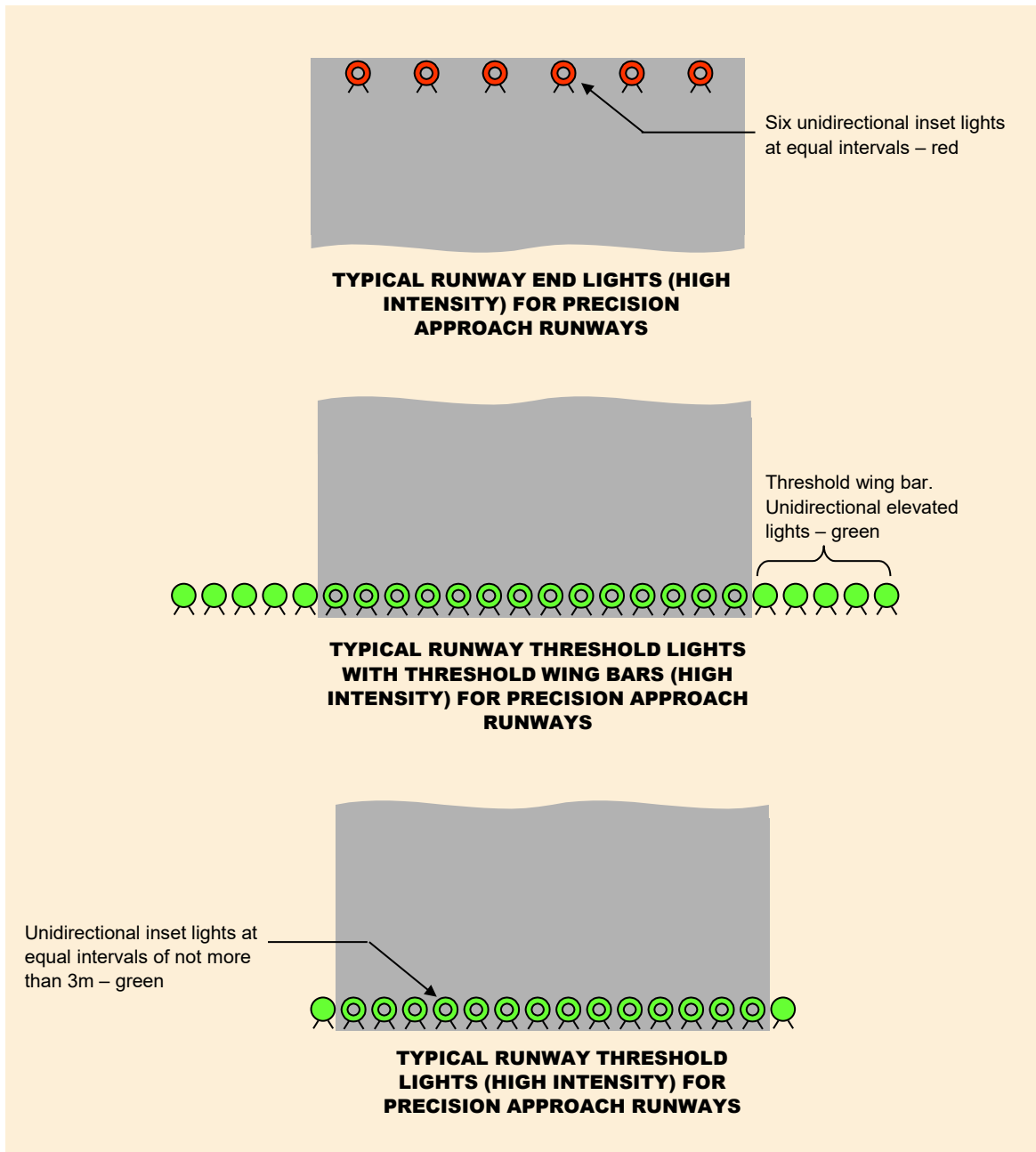


**Figure 9.76 (1) Runway edge lights, threshold lights and runway end lights for non-instrument and non-precision approach runways (illustrates matters)**

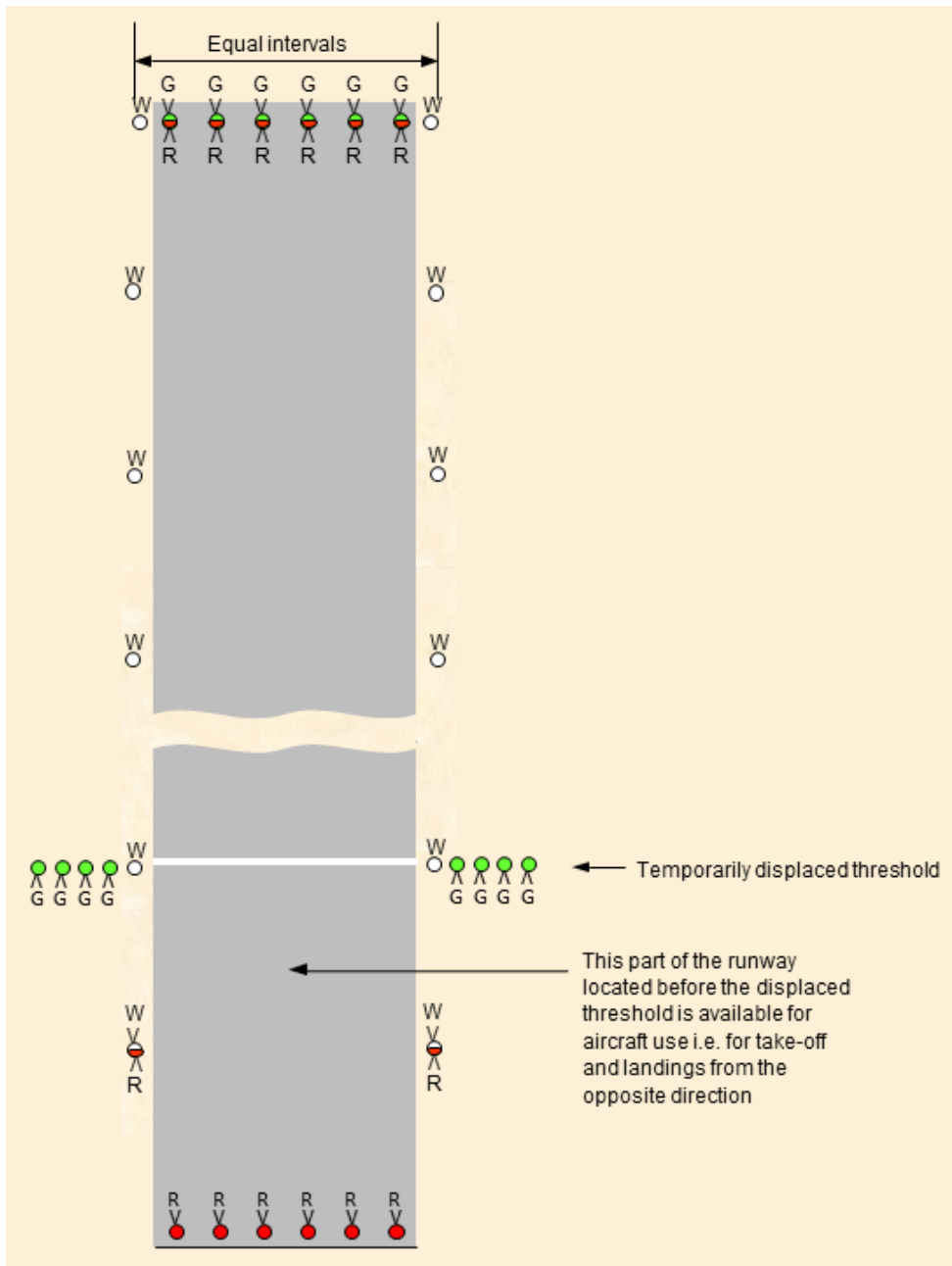




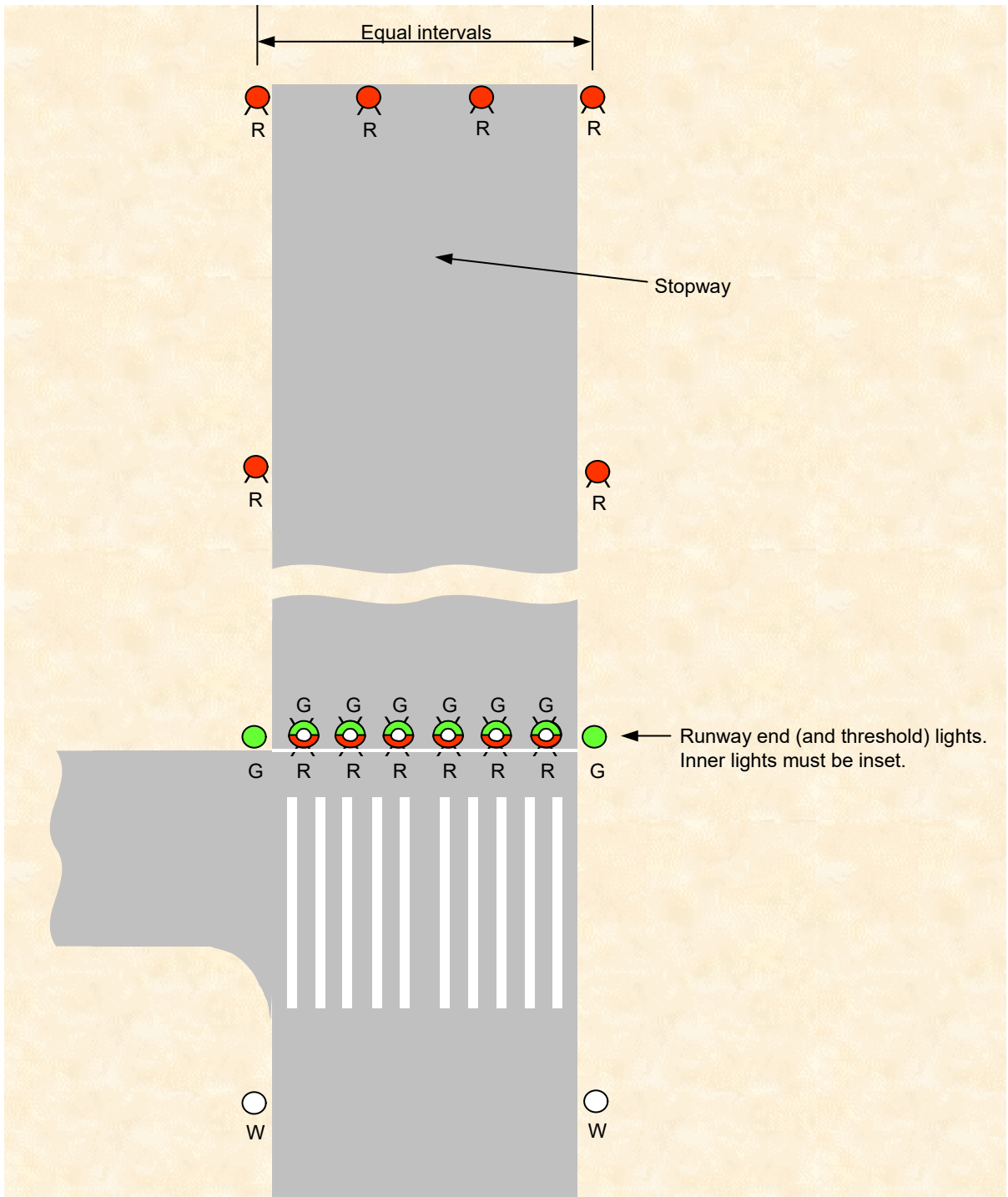
**Figure 9.76 (2) High-intensity runway edge lights for precision approach runways (illustrates matters)**



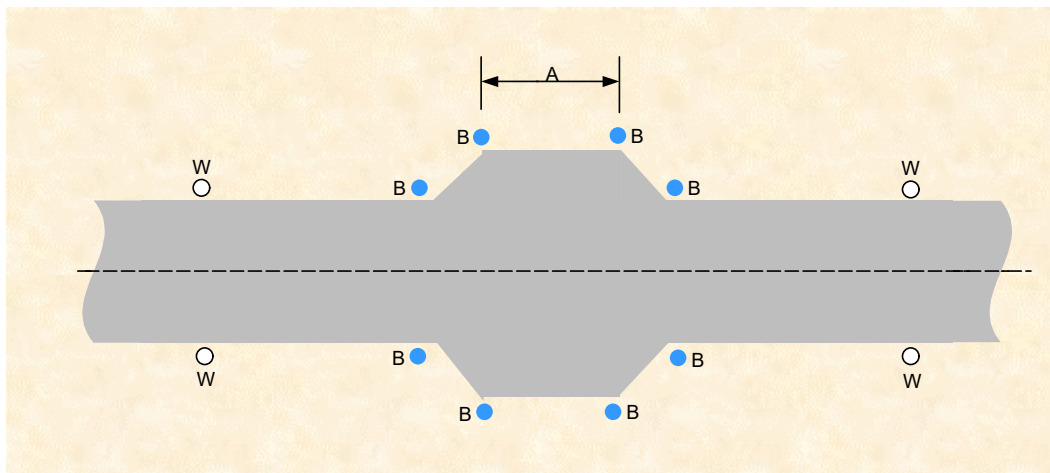
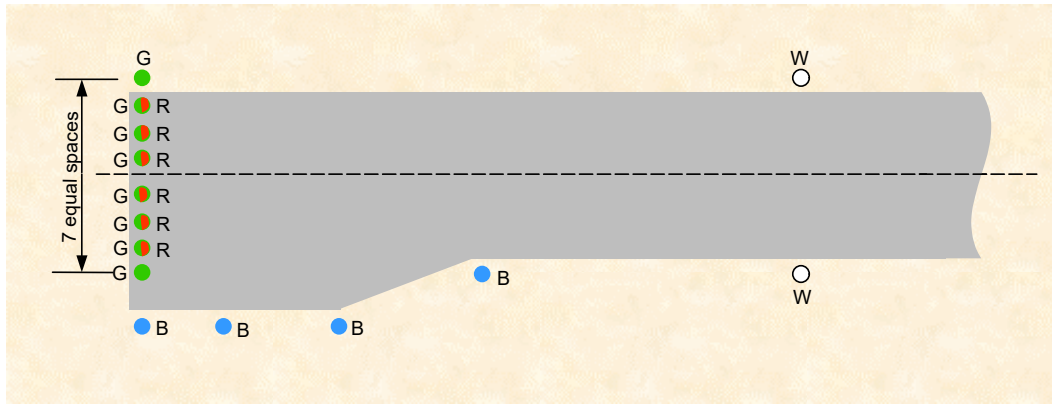
**Figure 9.76 (3) Typical runway threshold and runway end lights for precision approach runways (illustrates matters)**



**Figure 9.76 (4) Typical temporarily displaced threshold (illustrates matters)**



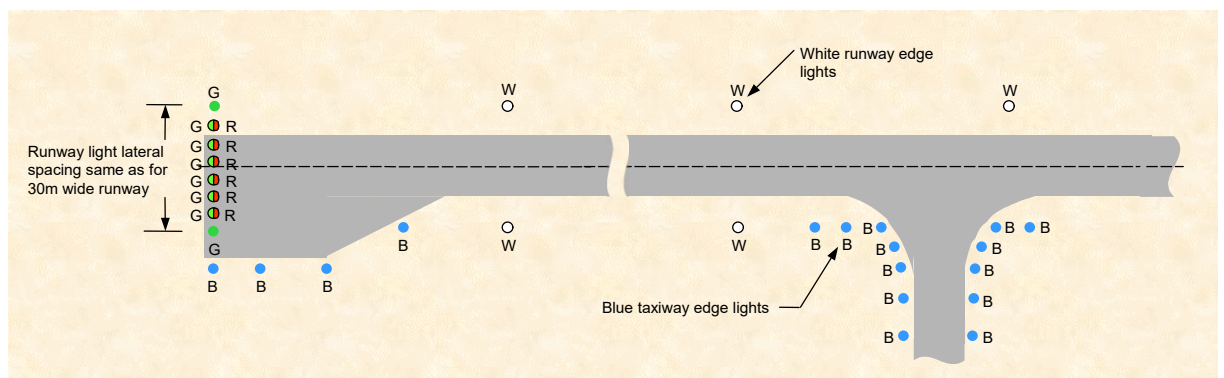
**Figure 9.76 (5) Typical stopway lights (illustrates matters)**



Where distance 'A' is longer than 30m, equally spaced lights not exceeding 30m spacing are to be included

Blue edge lights at the start of the splay are to be omitted where runway edge lights are located within 10m of the start of the splay

**Figure 9.76 (6) Typical turn pad edge lights (illustrates matters)**



**Figure 9.76 (7) Typical light layout where runway pavement is 23 m or 18 m wide (note: optional omnidirectional outer runway threshold lights provided) (illustrates matters)**

## CHAPTER 9

### Division 11 Taxiway lights

*Note* Figures 9.111 (1)-1, 9.111 (1)-2 and 9.111 (1)-3 illustrate taxiway centreline lighting layout and taxiway edge lighting layout.

#### 9.77 Provision of taxiway centreline lights

- (1) Subject to subsection (2), taxiway centreline lights must be provided:
  - (a) on an exit taxiway, a taxiway, and an apron, if the taxiway or apron is intended for use in visibility conditions less than 350 m; and
  - (b) in such a manner as to provide continuous guidance between the runway centreline and aircraft parking positions.

*Note* Taxiways intended for use in RVR conditions less than 1 200 m are recommended to have taxiway centreline lights provided unless the aerodrome traffic density is light.

- (2) Subsection (1) does not apply if:
  - (a) taxiway edge lights and centreline markings provide adequate guidance; and
  - (b) the aerodrome traffic density is light.
- (3) Taxiway centreline lights must be used on a rapid exit taxiway.
- (4) Subject to subsection (5), taxiway centreline lights must be provided on a runway:
  - (a) forming part of a standard taxi-route; and
  - (b) intended for taxiing in RVR conditions less than 350 m.
- (5) Subsection (4) does not apply if:
  - (a) taxiway edge lights and centreline markings are provided; and
  - (b) the aerodrome traffic density is light.

*Note* Taxiway centreline lights may be used in other circumstances than those mentioned in this section if the aerodrome operator considers that use of such lights will:

- (a) facilitate surface movements; and
- (b) avoid the “sea of blue” effect at aerodromes with multiple or complex taxiway layouts.

#### 9.78 Provision of taxiway edge lights

- (1) Subject to subsections 9.79 (1) and 9.80 (1), taxiway edge lights must be provided at the edges of a taxiway or a holding bay if the taxiway or holding bay is:
  - (a) intended for use at night; and
  - (b) not provided with centreline lights.
- (2) Taxiway edge lights must be provided on a runway if the runway:
  - (a) forms part of a standard taxi-route; and
  - (b) is intended for taxiing at night; and
  - (c) is not provided with taxiway centreline lights.
- (3) Taxiway edge lights may be used where additional visual cues are required to delineate apron edges at night.

## 9.79 Taxiway markers

- (1) For a code A or B taxiway, retroreflective taxiway centreline or taxiway edge markers may be used instead of taxiway centreline or taxiway edge lights, provided at least 1 taxiway from the runway to the apron has either taxiway centreline or taxiway edge lights provided.
- (2) If taxiway centreline lights are not provided, taxiway centreline markers may be used:
  - (a) to improve guidance on the taxiway; or
  - (b) to supplement:
    - (i) taxiway centreline markings; or
    - (ii) taxiway edge markers or taxiway edge lights.
- (3) If taxiway edge lights are not provided, taxiway edge markers may be used:
  - (a) to improve guidance on the taxiway; or
  - (b) to supplement:
    - (i) taxiway edge markings; or
    - (ii) taxiway centreline markers or taxiway centreline lights.

## 9.80 Apron taxiway lighting

- (1) Without affecting subsection 9.77 (1), for operations intended for visibility conditions of 350 m or more, taxiway lights are not required for an apron taxiway that is illuminated by apron floodlighting which meets the standards specified in sections 9.115 and 9.116.
- (2) For operations on an apron intended for visibility conditions less than 350 m RVR, taxiway centreline lights must be provided as follows:
  - (a) with a maximum light spacing of 15 m;
  - (b) in accordance with the taxiway centreline light specifications in subsection 9.111 including Figures 9.111 (3), 9.111 (4) or 9.111 (5), as applicable;
  - (c) in a manner that provides a pilot with positive guidance into the parking position.
- (3) Subsection (2) may not apply between the taxi lane dissection point and the commencement of the parking position if:
  - (a) the parking position is otherwise provided with an A-VDGS in accordance with Chapter 9, Division 13; and
  - (b) the A-VDGS is visible to the pilot at the dissection point and provides the pilot with positive guidance into the parking position.

## 9.81 Use of different types of taxiway lights

- (1) As far as possible, the provision of taxiway lights must be such that a taxiing aircraft is not required to alternate between taxiway edge and taxiway centreline lighting.
- (2) If any of the following:
  - (a) a rapid exit taxiway;
  - (b) a taxiway curve;
  - (c) a taxiway intersection;

- (d) a narrower section of taxiway;
- (e) a part of a taxiway;

has taxiway centreline lights, and requires additional guidance to delineate the taxiway edges, then taxiway edge lights that comply with sections 9.91 to 9.93 may be used.

- (3) Despite subsection (1), taxiway edge and taxiway centreline lighting may be alternated on a temporary basis during periods of works on the affected taxiway.

## 9.82 Control of lights on taxiways

On a standard taxi-route with runway lighting and taxiway lighting, the lighting systems must be interlocked to make simultaneous operation of both systems impossible.

## 9.83 Location of taxiway centreline lights

Taxiway centreline lights must be:

- (a) located along the centreline of the taxiway; or
- (b) if offset from the centreline — uniformly offset by not more than 0.3 m.

*Note* An offset of the taxiway centreline lights may be required to accommodate painting and maintenance of the taxiway centreline markings.

## 9.84 Spacing of taxiway centreline lights

- (1) Taxiway centreline lights on a straight section of a taxiway must be spaced at longitudinal intervals of not more than 30 m, except that:
  - (a) for taxiway sections with a length of 181 m or greater — longitudinal spacing intervals not exceeding 60 m may be used if this provides adequate guidance under the prevailing meteorological conditions; and
  - (b) on a taxiway intended for use in RVR conditions less than 350 m — the longitudinal spacing must not exceed 15 m.
- (2) When a taxiway changes from a straight to a curved section, the taxiway centreline lights must continue on from the preceding straight section at a uniform distance from the outside edge of the taxiway.
- (3) For taxiway centreline lights on a taxiway curve:
  - (a) the lights must be spaced at intervals such that a clear indication of the full extent of the curve is provided to the relevant pilot or ground vehicle pilot; and
  - (b) on a taxiway intended for use in visibility conditions less than 350 m — the spacing intervals must not exceed 15 m; and
  - (c) for use in visibility conditions less than 350 m on a curve with a radius of less than 400 m:
    - (i) the spacing interval must not exceed 7.5 m; and
    - (ii) the light spacing must extend for 60 m before the curve, and for 60 m after the curve; and
  - (d) for use in visibility conditions greater than 350 m on a curve with a radius of greater than 400 m — the spacing interval must not exceed 30 m; and



- (e) for use in visibility conditions greater than 350 m on a curve with a radius of less than 400 m — the spacing interval must not exceed 15 m.

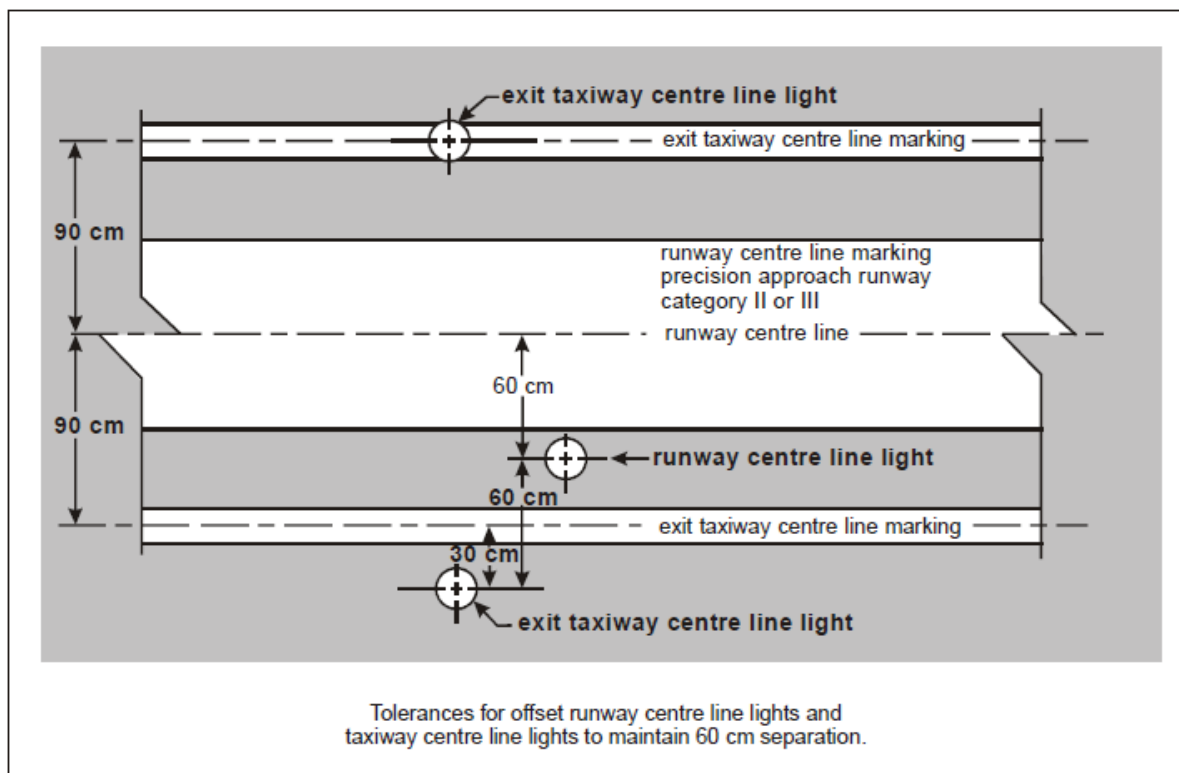
### 9.85 Location of taxiway centreline lights on entry and exit taxiways

- (1) For taxiways intended for visibility conditions less than 350 m — taxiway centreline lights must:
  - (a) continue towards the runway centreline; and
  - (b) when both centrelines converge — the taxiway centreline lights must:
    - (i) remain located on the taxiway side of the runway centreline; and
    - (ii) extend parallel to, and 1.2 m from, the runway centreline for a distance of not less than 60 m along the centreline in the direction of the aircraft taxi.

*Note* See also Figure 9.85 (1).

- (2) Despite paragraph (1) (b), the taxiway centreline lights may extend parallel to, and 0.9 m from, the runway centreline if the centreline lights are not obscured by marking the associated taxiway centreline on the runway.
- (3) For taxiways intended for visibility conditions of 350 m or greater — if the taxiway centreline lights do not continue towards the runway centreline, the last taxiway centreline light must not be more than 1 m outside the line of runway edge lights.
- (4) Despite subsection (1), subsection (3) may be applied for a taxiway entry at a runway end for visibility conditions less than 350 m.

*Note* Subsection 9.85 (4) applies to taxiway entry to the runway ends and not to any midpoint entries.



**Figure 9.85 (1) Typical offset runway and taxiway centreline lights (illustrates matters)**

### 9.86 Location of taxiway centreline lights on exit taxiways other than rapid exit taxiways

Taxiway centreline lights on an exit taxiway, other than a rapid exit taxiway, must:

- (a) start at the tangent point on the runway; and
- (b) have the first light offset 1.2 m from the runway centreline on the taxiway side; and
- (c) be spaced at uniform longitudinal intervals of not more than 7.5 m.

### 9.87 Location of taxiway centreline lights on rapid exit taxiways

Taxiway centreline lights on a rapid exit taxiway must:

- (a) start at least 60 m before the tangent point; and
- (b) on the part of the taxiway that is parallel to the runway centreline — be offset 1.2 m from the runway centreline on the taxiway side; and
- (c) be spaced at uniform longitudinal intervals of not more than 15 m; and
- (d) continue at the same spacing to a point on the centreline of the taxiway at which an aeroplane can be expected to have decelerated to normal taxiing speed.

### 9.88 Characteristics of taxiway centreline lights

(1) Subject to subsection (2), taxiway centreline lights:

- (a) on a taxiway, other than an exit taxiway; and
  - (b) on a runway forming part of a standard taxi-route;
- must be inset, fixed and show green.

(2) Taxiway centreline lights:

- (a) on an exit taxiway; and
- (b) on a rapid exit taxiway;

must:

- (c) be inset; and
- (d) be fixed; and
- (e) start with an alternating green and yellow light sequence at their beginning, and then show an alternating green and yellow sequence from the point where they begin near the runway centreline to whichever of the following (the *far point*) is furthest from the runway:
  - (i) the perimeter of the ILS critical and sensitive areas;
  - (ii) the lower edge of the inner transitional surface;
  - (iii) the corresponding runway holding position location for the taxiway as determined by Chapter 6, Division 3, of this MOS; and
- (f) show the last yellow light of the alternating green and yellow sequence at or beyond the far point; and
- (g) then show a green and green sequence thereafter.

*Note* Details of the ILS critical and sensitive areas may be obtained from the CNS provider, for example, Airservices Australia.

- (3) When viewed from the runway, the exit taxiway light nearest the far point must show yellow.
- (4) If the taxiway centreline lights are used for both runway exit and runway entry purposes, the colour of the lights viewed by the pilot of an aircraft must be:
  - (a) green for entering the runway; and
  - (b) alternately green and yellow for exiting the runway.

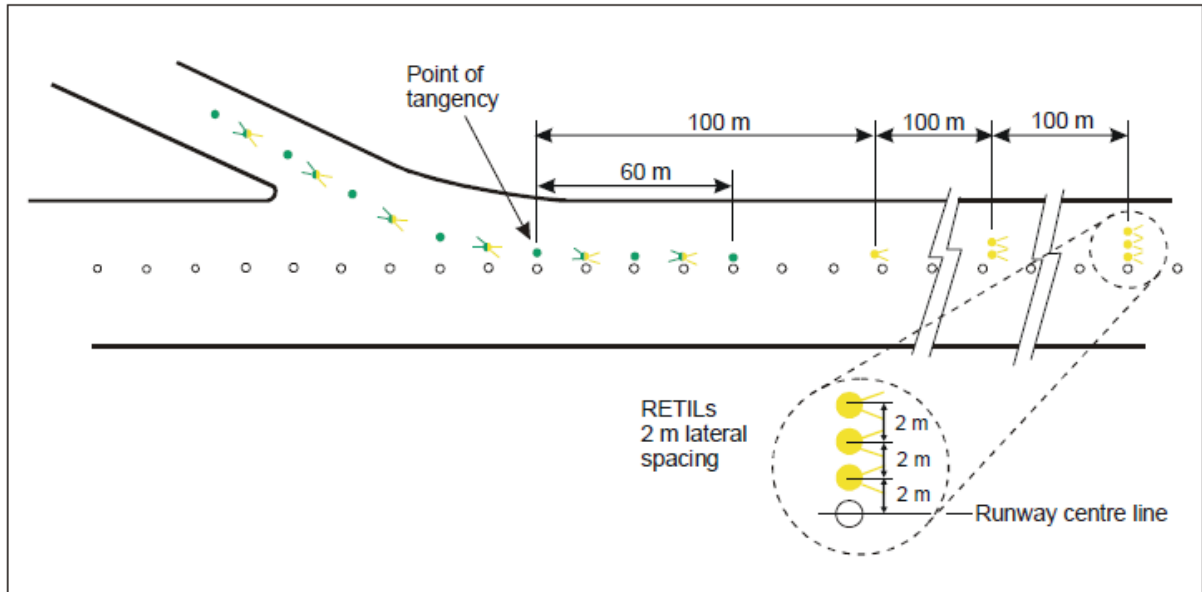
*Note* Refer to Figure 9.112-1 for an illustration of this configuration.

- (5) Taxiway centreline lights must cross an intersecting runway in visibility conditions less than 350 m, and may cross an intersecting runway in visibility conditions of 350 m or more.
- (6) Where the taxiway centreline lights cross an intersecting runway, the colour of the taxiway centreline lights viewed by a pilot of an aircraft entering the runway from the taxiway must be:
  - (a) green up to the runway centreline; and
  - (b) alternately green and yellow beyond the runway centreline while exiting on the other side of the runway; and
  - (c) not visible to a pilot located on the runway centreline.

### **9.89 Rapid exit taxiway indicator lights**

- (1) Rapid exit taxiway indicator lights (**RETIL**) may be provided on a runway intended for use in RVR conditions less than 350 m or where the traffic density is heavy.
- (2) If provided, RETIL must be displayed in the pattern shown in Figure 9.89 (2).
- (3) If provided, RETIL must not be displayed if any lamp or other failure of the lights prevents the display of the full light pattern as shown in Figure 9.89 (2).
- (4) If provided, a set of RETIL must be located on the runway on the same side of the runway centreline as the associated rapid exit taxiway, in the configuration shown in Figure 9.89 (2).
- (5) Each set of RETIL must be located 2 m apart from each other set, and the lights nearest to the runway centreline must be displaced 2 m from the runway centreline.
- (6) Where more than one rapid exit taxiway exists on a runway, the set of RETIL for each exit must not overlap when displayed.
- (7) If provided, RETIL must be fixed, unidirectional, yellow lights, aligned so as to be visible to the pilot of a landing aeroplane in the direction of approach to the runway.
- (8) If provided, the light intensity of RETIL must be in accordance with the specifications in Figure 9.75 (8) or 9.75 (9), as appropriate.

*Note* CASA recommends that RETIL be supplied with power on a separate circuit to other runway lighting so that they may be used when other lighting is switched off.



**Figure 9.89 (2) Rapid exit taxiway indicator lights (shows matters)**

### 9.90 Beam dimensions and light distribution of taxiway centreline lights

- (1) The beam dimensions and light distribution of taxiway centreline lights must be such that the lights are visible only to the pilot of an aircraft on, or in the vicinity of, the taxiway.
- (2) The light distribution of the green taxiway centreline lights in the vicinity of a threshold must be such as not to be confused with the runway threshold lights.
- (3) On a taxiway intended for use in visibility conditions of 350 m or greater, taxiway centreline lights must comply with the specifications set out in Figure 9.111 (1) or Figure 9.111 (2), whichever is applicable.
- (4) On a taxiway intended for use in visibility conditions less than 350 m, the taxiway centreline lights must have light intensity in accordance with Figure 9.111 (3), Figure 9.111 (4) or Figure 9.111 (5), whichever is applicable.

*Note* Light units meeting the intensity standards shown in Figure 9.111 (3), Figure 9.111 (4) and Figure 9.111 (5), are specifically designed for use in low-visibility conditions. For the normal range of visibilities experienced most of the time in Australia, these lights, if operated on maximum intensity, would cause dazzle to pilots. If these lights are installed, CASA recommends that additional intensity control stages are provided, or that the maximum intensity at which they can be operated be otherwise limited.

### 9.91 Location of taxiway edge lights

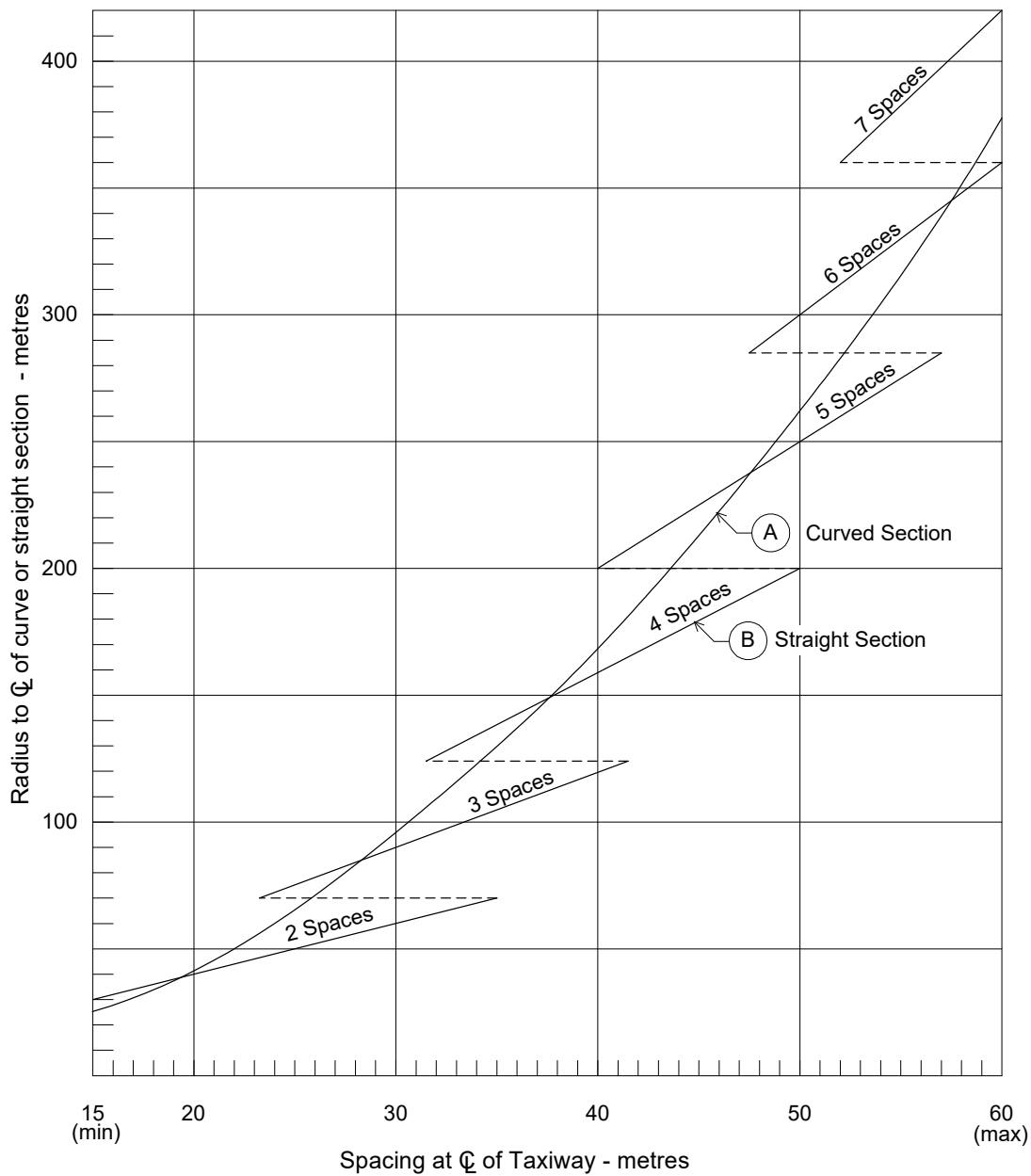
- (1) Subject to subsection (2), taxiway edge lights must be located opposite to each other along both sides of a taxiway.
- (2) A taxiway edge light may be omitted if it would otherwise have to be located:
  - (a) on an intersection with another taxiway; or
  - (b) on a runway; or
  - (c) to facilitate taxiway curves with small radii.

- (3) Taxiway edge lights must be located outside the edge of the taxiway:
  - (a) equidistant from the centreline, except where asymmetric fillets are provided; and
  - (b) preferably 1.2 m from the taxiway edge, but no farther than 1.8 m, and no nearer than 0.6 m.

*Note* Where a taxiway intersects with a runway, the last taxiway edge lights should preferably line up with the line of runway edge lights, and must not encroach beyond the line of runway edge lights (into the area outlined by the runway edge lights).

### **9.92 Spacing of taxiway edge lights**

- (1) This section does not apply if any of the following make its application impossible:
  - (a) the alignment of the taxiway;
  - (b) the radius of the taxiway curve;
  - (c) the general taxiway environment;provided that a description and explanation of the limitation and its effects is recorded in the aerodrome manual.
- (2) Spacing of taxiway edge lights must be such that the edge lights are:
  - (a) clearly visible to pilots for an intended operation; and
  - (b) as far as possible, in accordance with Figure 9.92 (2).
- (3) On a curved section of taxiway, the taxiway edge lights must be spaced at uniform longitudinal intervals in accordance with Curve A in Figure 9.92 (2).
- (4) On a straight section of taxiway, the taxiway edge lights must be spaced at uniform longitudinal intervals not exceeding 60 m.
- (5) Where a straight section of taxiway joins a curved section, the longitudinal spacing between taxiway edge lights must be progressively reduced, in accordance with subsections (6) and (7), over not less than 3 spacings before the tangent point.
- (6) For subsection (5), the last spacing between lights on a straight section must be the same as the spacing on the curved section.
- (7) For subsection (5), if the last spacing on the straight section is less than 25 m, the second last spacing on the straight section must be no greater than 25 m.
- (8) If a straight section of taxiway enters an intersection with another taxiway, a runway or an apron, the longitudinal spacing of the taxiway edge lights must be progressively reduced over not less than 3 spacings before the tangent point, so that the last and the second last spacings before the tangent point are not more than 15 m and 25 m, respectively.
- (9) The taxiway edge lights must continue around the edge of the curve to the tangent point on the other taxiway, runway or apron edge.
- (10) Taxiway edge lights on a holding bay or apron edge must be spaced at uniform longitudinal intervals not exceeding 60 m, and in accordance with Line B in Figure 9.92 (2).



**Figure 9.92 (2) Longitudinal spacing for taxiway edge lights (shows matters)**

### 9.93 Characteristics of taxiway edge lights

- (1) Taxiway edge lights must:
  - (a) be fixed; and
  - (b) be omnidirectional; and
  - (c) show blue; and
  - (d) unless shielded under subsection (2), be visible as follows:
    - (i) up to at least 30° above the horizontal;

- (ii) at all angles in azimuth necessary to provide guidance to the pilot of an aircraft on the taxiway.
- (2) If the lights are likely to cause confusion at an intersection, exit or curve, they may be shielded in a way that minimises confusion with other lights while achieving an appropriate degree of visibility.
- (3) The peak intensity of the blue edge lights must not be less than 5 cd.

#### **9.94 Taxiway edge markers**

If taxiway edge markers are used, such markers must be installed at least in the same locations as taxiway edge lights would have been installed had such lights been used.

*Note* Taxiway edge markers must be used in accordance with section 9.79.

#### **9.95 Characteristics of taxiway edge markers**

- (1) Taxiway edge markers must be retroreflective blue.
- (2) The surface of a taxiway edge marker, as viewed by the pilot of an approaching aircraft, must be:
  - (a) rectangular; and
  - (b) with a height to width ratio of approximately 3:1; and
  - (c) with a minimum viewing area of 150 cm<sup>2</sup>.
- (3) Taxiway edge markers must be:
  - (a) lightweight; and
  - (b) frangible; and
  - (c) low enough to preserve adequate clearance for propellers and jet aircraft engine pods.

#### **9.96 Taxiway centreline markers**

If taxiway centreline markers are used, such markers must be installed at least in the same locations as taxiway centreline lights would have been installed had such lights been used.

*Note* Taxiway centreline markers must be used in accordance with section 9.79.

#### **9.97 Characteristics of taxiway centreline markers**

- (1) Taxiway centreline markers must be retroreflective green.
- (2) The marker surface, as viewed by the pilot of an approaching aircraft, must be a rectangle with a minimum viewing surface of 15 cm<sup>2</sup>.

*Note* Reflective pavement markers or “cats-eyes” are typically able to satisfy this requirement.
- (3) Taxiway centreline markers must be able to withstand being run over by the wheels of an aircraft without damage either to the aircraft or to the markers themselves.

#### **9.98 Provision of runway guard lights**

*Note* Runway guard lights are sometimes referred to as “wig wags”.

- (1) Runway guard lights must be provided at the intersection of a taxiway with a runway intended for use in:
  - (a) visibility conditions less than 550 m, if stop bars are not installed; or

- (b) visibility conditions between 550 m and 1 200 m, when the aerodrome traffic density is heavy.

*Note 1* An aerodrome that is not required to provide runway guard lights may choose to do so as an aid to reducing runway incursions.

*Note 2* CASA recommends that runway guard lights be installed in conjunction with a stop bar.

- (2) If runway guard lights are provided for a runway, they must be installed and used at all taxiways and road access points that allow access to the runway.
- (3) Despite subsection (2), runway guard lights are not required for a taxiway if:
  - (a) the taxiway is used only for exiting from the runway; and
  - (b) the taxiway cannot be used for entry to the runway by either aircraft or vehicles.

### **9.99 Pattern and location of runway guard lights**

- (1) Subject to subsection (2), runway guard lights must be either:
  - (a) elevated runway guard lights on each side of the taxiway (*Configuration A*); or
  - (b) in-pavement runway guard lights across the taxiway (*Configuration B*).
- (2) Both elevated and in-pavement runway guard lights must be used together when increased conspicuity of the taxiway/runway intersection is required, for example:
  - (a) if holding position markings do not extend straight across the taxiway; or
  - (b) on a wide taxiway, if elevated lights on both sides of the taxiway are not within the normal field of view of a pilot approaching the runway guard lights.
- (3) Elevated runway guard lights must be located:
  - (a) on both sides of the taxiway at the runway holding position closest to the runway, and
  - (b) equidistant from the taxiway centreline; and
  - (c) not less than 3 m, and not more than 5 m, outside the edge of the taxiway.
- (4) In-pavement runway guard lights must be located:
  - (a) across the entire taxiway, including fillets and holding bays; and
  - (b) at the runway holding position closest to the runway; and
  - (c) with the lights spaced at uniform intervals of 3 m.

### **9.100 Characteristics of runway guard lights**

- (1) Configuration A runway guard lights must consist of a pair of elevated lights showing yellow on each side of the taxiway.
- (2) Configuration B runway guard lights must consist of inset lights showing yellow across the taxiway.
- (3) The performance of Configuration A runway guard lights must comply with the following requirements:
  - (a) the lights in each pair must be illuminated alternately at between 30 and 60 flashes per light per minute;
  - (b) the light suppression and illumination periods of each light in a pair must, if possible, be of equal and opposite duration;



- (c) the light beams must be unidirectional and aimed so that the beam centres cross the taxiway centreline at a point 60 m before the runway holding position;
  - (d) the effective intensity of the yellow light and beam spread must be the same as that in the specifications in Figure 9.111 (6).
- (4) The performance of Configuration B runway guard lights must comply with the following requirements:
- (a) the lights must illuminate as a single unit of lights but with adjacent lights flashing alternately at between 30 and 60 flashes per minute;
  - (b) the light suppression and illumination periods of each light must, if possible, be of equal and opposite duration;
  - (c) the light beams must be unidirectional and aligned so as to be visible to the pilot of an aeroplane taxiing to the holding position;
  - (d) the effective intensity of the yellow beam and beam spread must be the same as that in the specifications in Figure 9.111 (3).

### 9.101 Control of runway guard lights

All runway guard lights for a runway must be capable of being turned on when the runway is active, whether by day or night.

### 9.102 Provision of intermediate holding position lights

Intermediate holding position lights must be provided at the following locations:

- (a) if runway guard lights or stop bars are not provided — the runway holding position on a taxiway serving a runway equipped for night use;
- (b) if the holding bay is intended to be used at night— the holding position of a holding bay;
- (c) taxiway/taxiway intersections if:
  - (i) the intersection is intended for use in RVR conditions less than 350 m; and
  - (ii) it is necessary to identify the aircraft holding position;
- (d) a designated intermediate holding position on a taxiway intended for night use.

*Note* Provision of intermediate holding position lights for subparagraph (c) (ii) and paragraph (d) is based on local ATC procedural requirements.

### 9.103 Pattern and location of intermediate holding position lights

- (1) On a taxiway equipped with centreline lights, the intermediate holding position lights must consist of at least 3 lights that are:
  - (a) inset, and spaced 1.5 m apart; and
  - (b) disposed symmetrically about, and at right angles to, the taxiway centreline; and
  - (c) located not more than 0.3 m before whichever of the following is appropriate, depending on the required location of the intermediate holding position lights:
    - (i) the intermediate holding position marking;
    - (ii) the taxiway intersection marking.

- (2) On a taxiway equipped with taxiway edge lights, the intermediate holding position lights must:
  - (a) consist of 1 elevated light on each side of the taxiway; and
  - (b) be located in line with:
    - (i) the taxiway edge lights; and
    - (ii) one of the following:
      - (A) the runway holding position marking;
      - (B) the intermediate holding position marking;
      - (C) the taxiway intersection marking.

#### **9.104 Characteristics of intermediate holding position lights**

- (1) Inset intermediate holding position lights must:
  - (a) be fixed, unidirectional lights showing yellow; and
  - (b) be aligned so as to be visible to the pilot of an aircraft approaching the holding position; and
  - (c) have light distribution as close as possible to that of the taxiway centreline lights.
- (2) Elevated intermediate holding position lights must:
  - (a) be fixed, omnidirectional lights showing yellow; and
  - (b) have light distribution as close as possible to that of the taxiway edge lights.

#### **9.105 Stop bars**

- (1) If a runway or a system of runways is intended to be used in RVR conditions less than 350 m, a stop bar must be provided at each runway holding position serving the runway or the system of runways.
- (2) Subsection (1) does not apply if operational procedures ensure that, in RVR conditions less than 350 m, the number of:
  - (a) aircraft on the manoeuvring area is limited to 1 at a time; and
  - (b) vehicles on the manoeuvring area is limited to the minimum essential for safe aerodrome operations.
- (3) If a runway is intended to be used in RVR conditions of at least 350 m but less than 550 m, a stop bar must be provided at each runway holding position serving the runway.
- (4) Subsection (3) does not apply if:
  - (a) operational procedures ensure that in RVR conditions of at least 350 m but less than 550 m, the number of:
    - (i) aircraft on the manoeuvring area is limited to 1 at a time; and
    - (ii) vehicles on the manoeuvring area is limited to the minimum essential for safe aerodrome operations; or
  - (b) appropriate aids and procedures designed to prevent the inadvertent incursion of aircraft or vehicles onto the runway are in force for the runway.

*Note 1* Stop bars require direct ATC control. Therefore, CASA recommends that an aerodrome operator should consult with ATC before planning their introduction. If provided, the control mechanism for stop bars should meet the operational requirements of the ATS provider at that aerodrome.

*Note 2* CASA recommends that stop bars be used in RVR conditions of 550 m or more, or generally, to prevent runway incursions.

### **9.106 Location of stop bars**

A stop bar must:

- (a) be located across the taxiway on, or not more than 0.3 m before, the point at which it is intended that traffic approaching the runway must stop; and
- (b) consist of inset lights spaced 3 m apart across the taxiway; and
- (c) be disposed symmetrically about, and at right angles to, the taxiway centreline; and
- (d) be supplemented with a pair of elevated lights that:
  - (i) have the same characteristics as the stop bar lights; and
  - (ii) are provided abeam the stop bar; and
  - (iii) are located at a distance of at least 3 m from the taxiway edge.

### **9.107 Characteristics of stop bar lights**

- (1) A stop bar must:
  - (a) be unidirectional; and
  - (b) show red in the direction of approach to the stop bar.
- (2) The intensity and beam spread of the stop bar lights must be in accordance with the applicable specifications in Figures 9.111 (1) to 9.111 (5).
- (3) Selectively-switchable stop bars must be installed in conjunction with at least 3 taxiway centreline lights that extend for a distance of at least 90 m from the stop bar in the direction that it is intended for an aircraft to proceed from the stop bar.
- (4) The lighting circuit of a stop bar must be designed so that:
  - (a) stop bars located across the entrances to taxiways are selectively switchable; and
  - (b) stop bars located across taxiways used as exit taxiways only are switchable selectively or in groups; and
  - (c) when a stop bar is illuminated, any taxiway centreline lights immediately beyond the stop bar are extinguished for a distance of at least 90 m; and
  - (d) when a stop bar is extinguished, any taxiway centreline lights immediately beyond the stop bar are illuminated for a distance of at least 90 m; and
  - (e) with control interlock (not manual control):
    - (i) if the taxiway centreline lights beyond the stop bar are illuminated — the stop bar is extinguished; and
    - (ii) if the stop bar lights are illuminated — the taxiway centreline lights beyond the stop bar are extinguished.

### 9.108 No entry bars

- (1) No entry bars must be provided at the entry of a permanently closed taxiway at an aerodrome available for use at night where aircraft no entry signs as specified in section 8.90 are not provided.
- (2) No entry bars may be provided at the entry of a permanently closed taxiway or an exit-only taxiway.

*Note 1* Runway incursions may take place in all visibility or weather conditions. The provision of no entry bars at taxiway/runway intersections and their use at night and in all visibility conditions can form part of effective runway incursion prevention measures.

*Note 2* It is recommended that a no entry bar should be provided across a taxiway which is intended to be used as an exit-only taxiway to assist in preventing inadvertent access of traffic to that taxiway.

- (3) If provided, a no entry bar must:
  - (a) be located across the taxiway on, or not more than 0.3 m before, the point at which it is intended that traffic approaching the closed or exit-only taxiway must stop; and
  - (b) consist of inset lights spaced 3 m apart across the taxiway; and
  - (c) be disposed symmetrically about, and at right angles to, the taxiway centreline.

*Note* It is recommended that the no entry bar is supplemented with a pair of elevated lights that:

- (i) have the same characteristics as elevated stop bar lights; and
  - (ii) are provided abeam the no entry bar; and
  - (iii) are located at a distance of at least 3 m from the taxiway edge.
- (4) No entry bar lights must:
    - (a) be unidirectional; and
    - (b) show red in the direction of approach to the no entry bar.
  - (5) The intensity and beam spread of the no entry bar lights must be in accordance with the applicable specifications in Figures 9.111 (1) to 9.111 (5).

### 9.109 Photometric characteristics of taxiway lights

- (1) The average intensity of the main beam of a taxiway light is calculated by:
  - (a) establishing the grid points in accordance with the method shown in Figure 9.111 (7) in section 9.111; and
  - (b) measuring the light intensity values at all grid points located within, and on the perimeter of, the rectangle representing the main beam; and
  - (c) calculating the arithmetic average of the light intensity values as measured at those grid points.
- (2) The maximum light intensity value measured on, or within, the perimeter of the main beam must not be more than 3 times the minimum light intensity value so measured.

### 9.110 Installation and aiming of light fittings

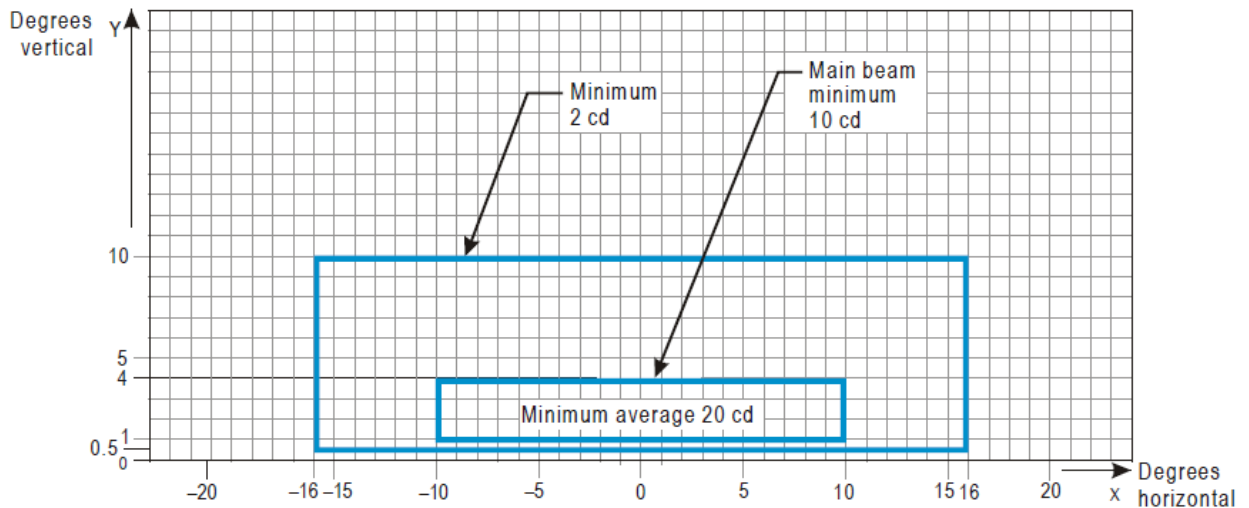
For the installation and aiming of light fittings, the following requirements must be complied with:

- (a) the lights must be aimed so that there are no deviations in the main beam pattern, to within 0.5 degrees of the applicable standard;

- (b) horizontal angles must be measured with respect to the vertical plane through the taxiway centreline;
- (c) when measuring horizontal angles for lights other than taxiway centreline lights, the direction towards the taxiway centreline must be taken to be positive;
- (d) vertical angles specified must be measured with respect to the horizontal plane.

### 9.111 Isocandela diagrams for taxiway lights

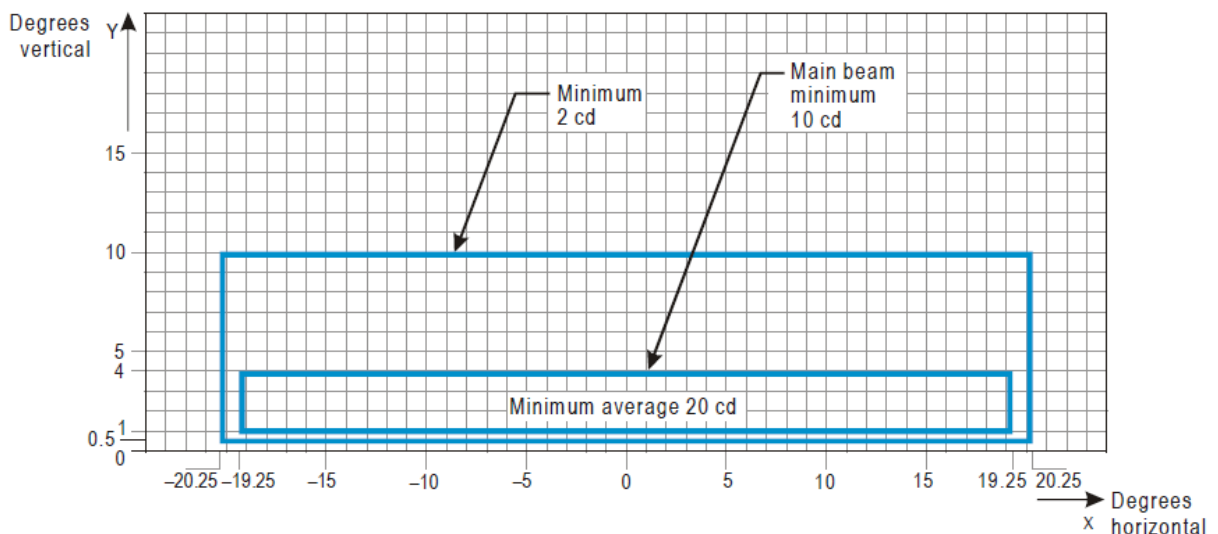
- (1) Figures 9.111 (1) to 9.111 (5) show candela values:
  - (a) in green and yellow for taxiway centreline lights; and
  - (b) in red for no entry bar lights and stop bar lights.
- (2) Figures 9.111 (1) to 9.111 (5) show the minimum allowable light intensities.
- (3) The average intensity of the main beam is calculated by:
  - (a) establishing grid points as shown in Figure 9.111 (7); and
  - (b) using the intensity values measured at all grid points located within and on the perimeter of the rectangle representing the main beam; and
  - (c) calculating the arithmetic average of the light intensity values measured at those grid points.
- (4) No deviations in candela values are permitted in the main beam when the lighting fixture is properly aimed.
- (5) Horizontal angles must be measured with respect to the vertical plane through the taxiway centreline, except on curves which must be measured with respect to the tangent to the curve.
- (6) Vertical angles must be measured from the longitudinal slope of the taxiway surface.
- (7) The light unit must be installed so that the main beam is aligned within 0.5 degrees of the specified requirement.
- (8) On the perimeter of, and within the rectangle defining the main beam, the maximum light intensity value must not to be greater than 3 times the minimum light intensity measured in the same way.
- (9) The following apply to the Figures:
  - (a) for Figure 9.111 (1) — if omnidirectional lights are used they must comply with the vertical beam spread;
  - (b) for Figures 9.111 (2) and 9.111 (5) — lights on curves must have the light beam toed-in 15.75° with respect to the tangent of the curve.



**Figure 9.111 (1) Isocandela diagram for taxiway centreline lights, no entry bar lights and stop bar lights on straight sections of taxiways intended for use in RVR conditions of 350 m or greater (shows matters)**

*Notes*

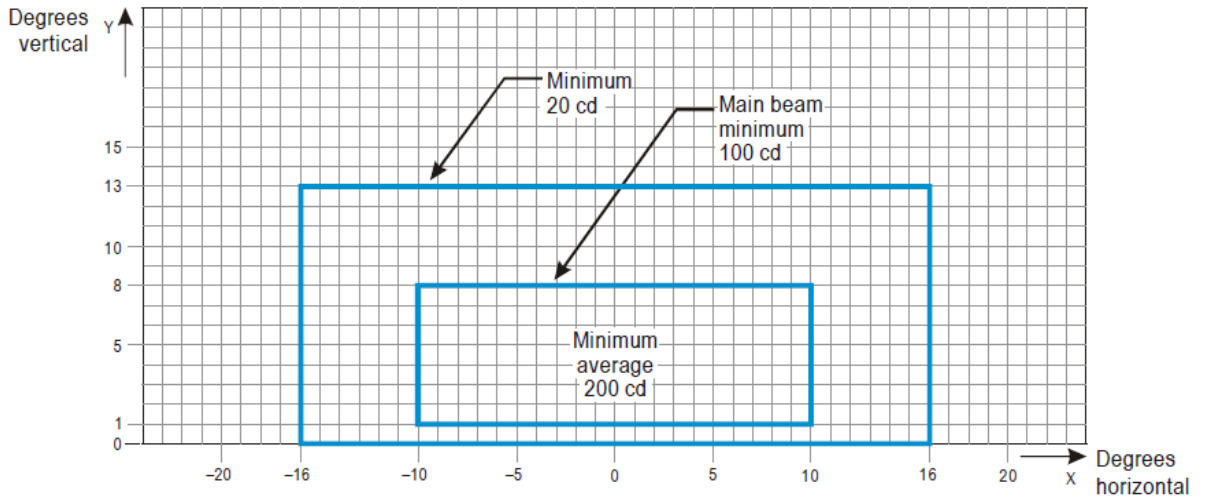
1. The intensity values have taken into account high background luminance, and the possibility of deterioration of light output resulting from dust and local contamination.
2. If omnidirectional lights are used they must comply with the vertical beam spread.



**Figure 9.111 (2) Isocandela diagram for taxiway centreline lights, no entry bar lights and stop bar lights on curved sections of taxiways intended for use in RVR conditions of 350 m or greater (shows matters)**

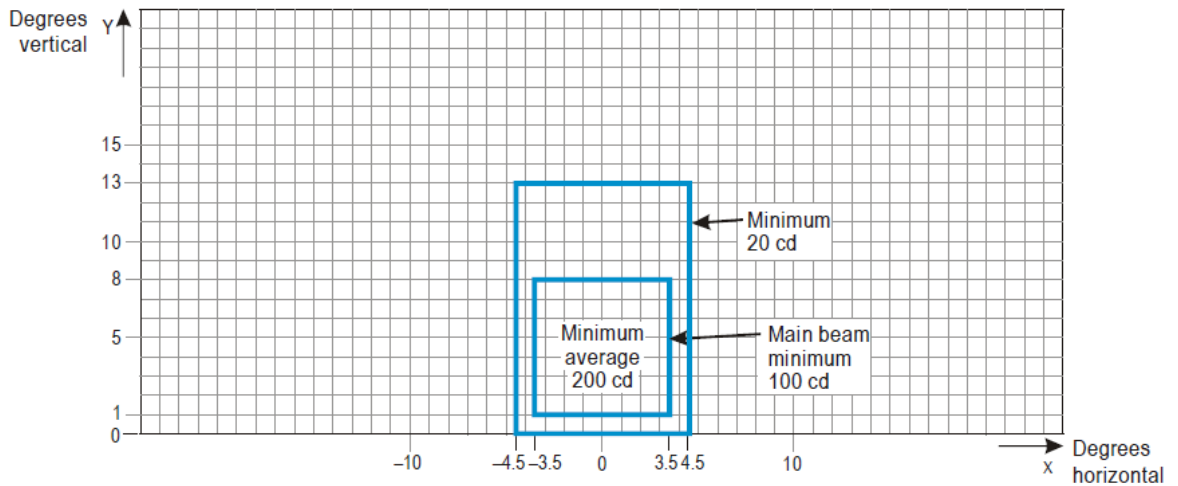
*Notes*

1. The intensity values have taken into account high background luminance, and the possibility of deterioration of light output resulting from dust and local contamination.
2. Lights on curves must have the light beam toed-in 15.75° with respect to the tangent to the curve.
3. These beam coverages allow for displacement of the cockpit from the centreline up to a distance of 12 m as could occur at the end of curves.



**Figure 9.111 (3) Isocandela diagram for taxiway centreline lights, no entry bar lights and stop bar lights on taxiways intended for use in RVR conditions less than 350 m — for use on straight sections of taxiways where large offsets can occur; also for runway guard lights, Configuration B (shows matters)**

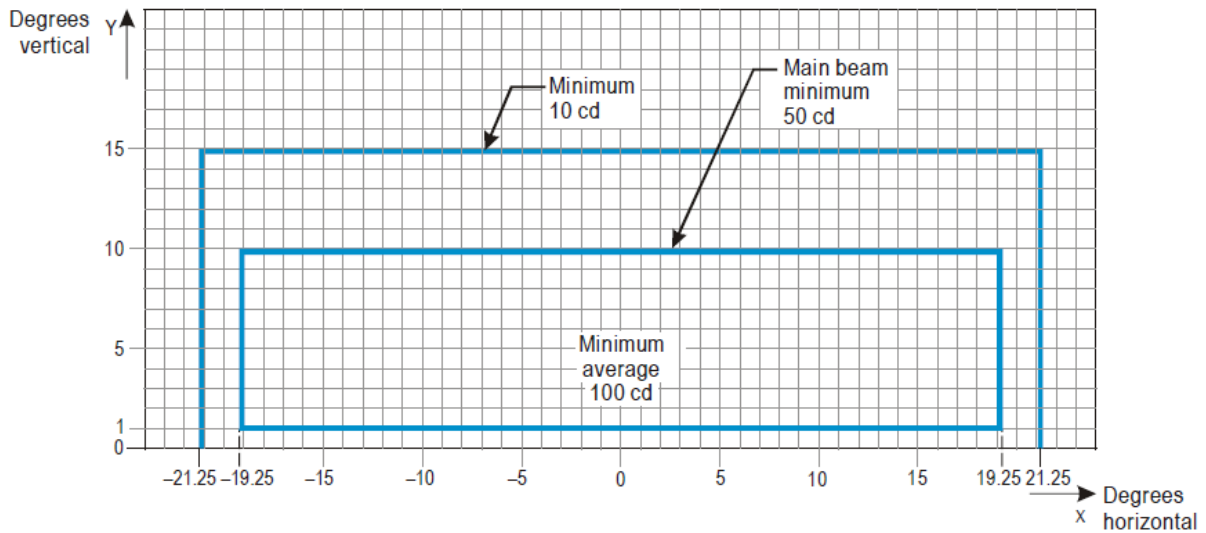
*Note* These beam coverages allow for displacement of the cockpit from the centreline of up to a distance of 12 m and are intended for use before and after curves.



**Figure 9.111 (4) Isocandela diagram for taxiway centreline lights, no entry bar lights and stop bar lights on taxiways intended for use in RVR conditions less than 350 m — for use on straight sections of taxiways where large offsets do not occur (shows matters)**

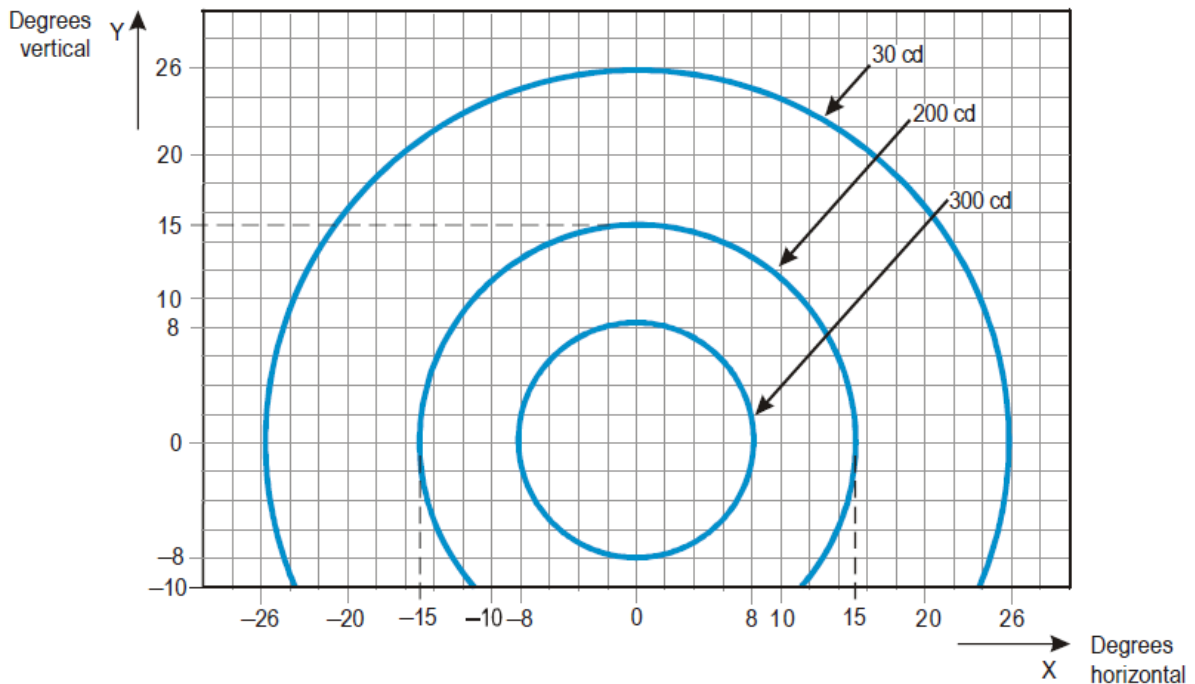
*Note 1* These beam coverages are suitable for a normal displacement of the cockpit from the centreline of up to 3 m.

*Note 2* See section 9.111 concerning these isocandela diagrams.



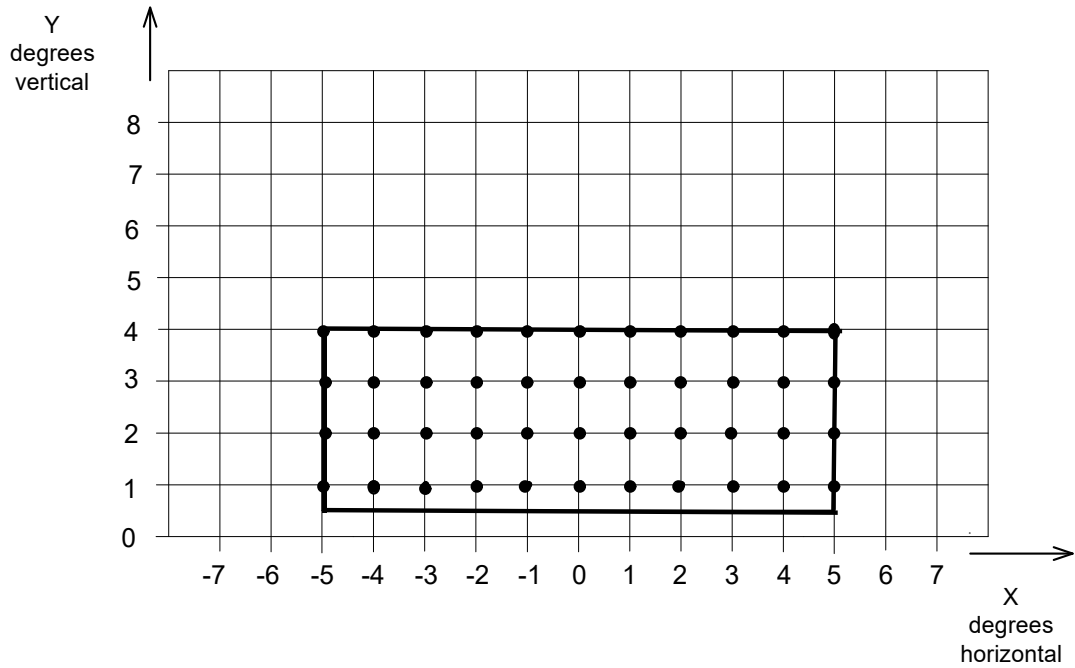
**Figure 9.111 (5) Isocandela diagram for taxiway centreline lights, no entry bar lights and stop bar lights on taxiways intended for use in RVR conditions less than 350 m — for use on curved sections of taxiways (shows matters)**

*Note* Lights on curves must have the light beam toed-in  $15.75^\circ$  with respect to the tangent to the curve.



**Figure 9.111 (6) Isocandela diagram for each light in runway guard lights, Configuration A (shows matters)**



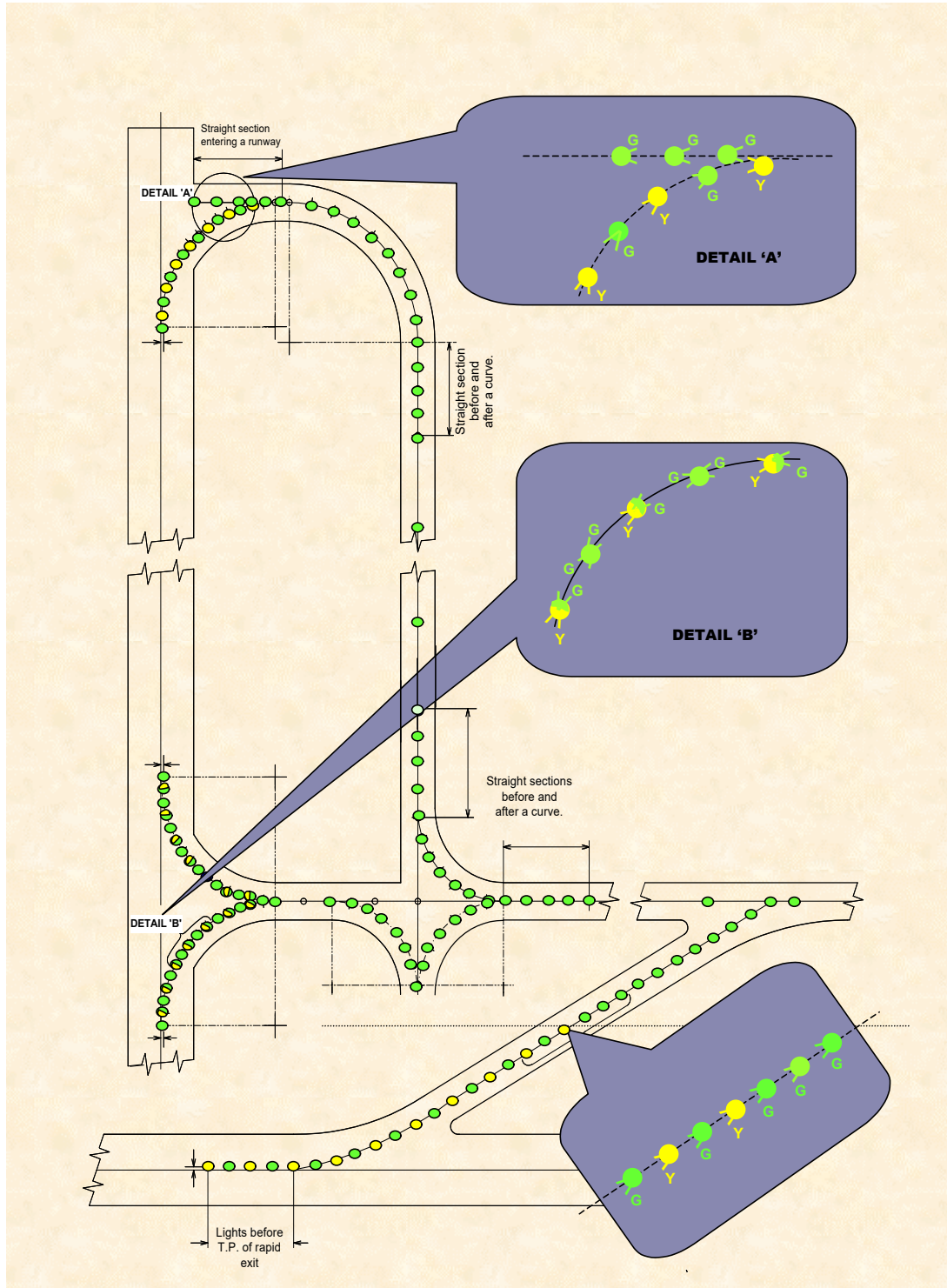


**Figure 9.111 (7) Method of establishing grid points to be used for calculation of average intensity of taxiway centreline lights, no entry bar lights and stop bar lights (shows matters)**

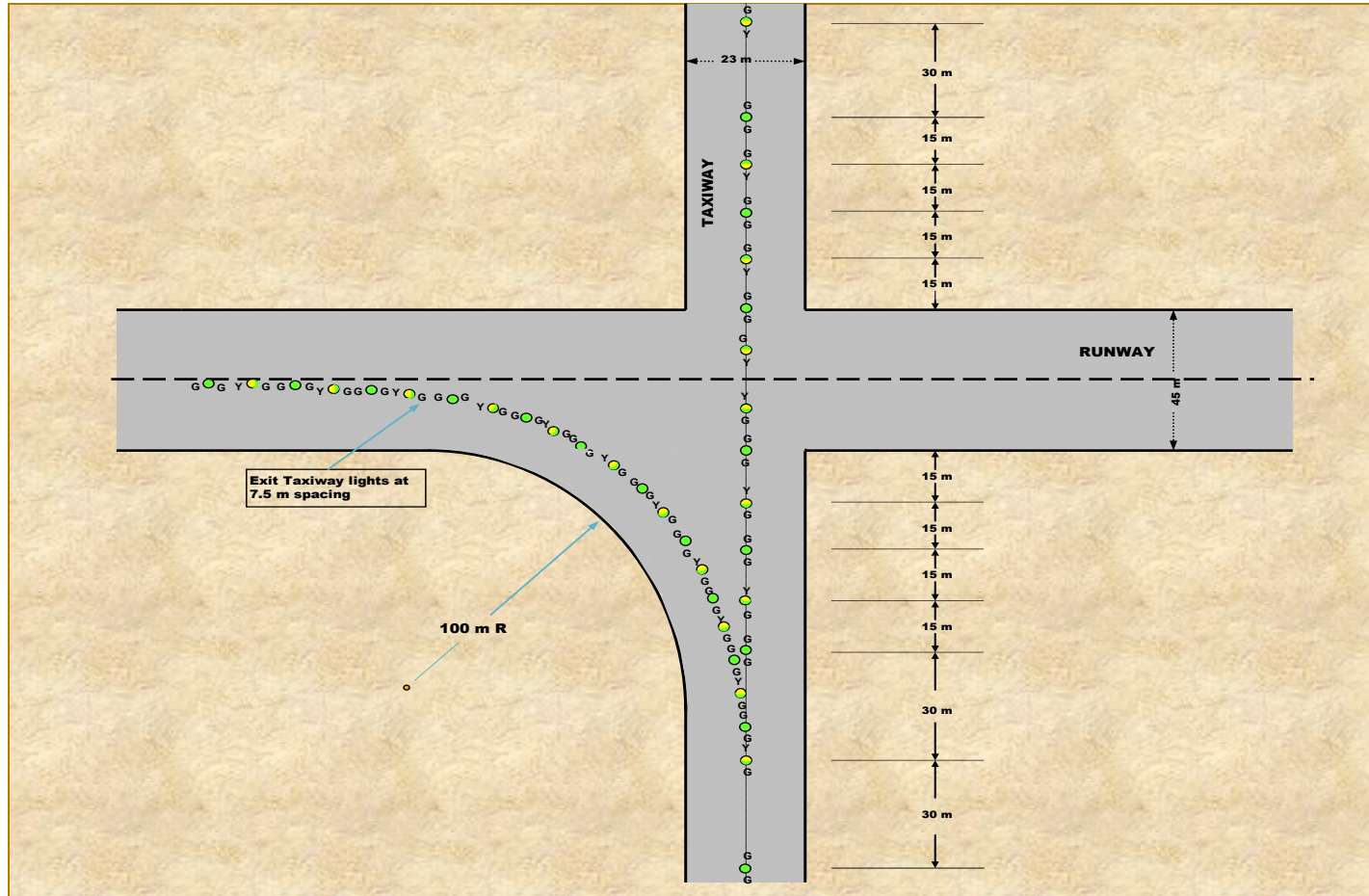
### 9.112 Illustrations of taxiway lighting

The Figures in this section illustrate matters for taxiway lighting for the purposes of this Division.

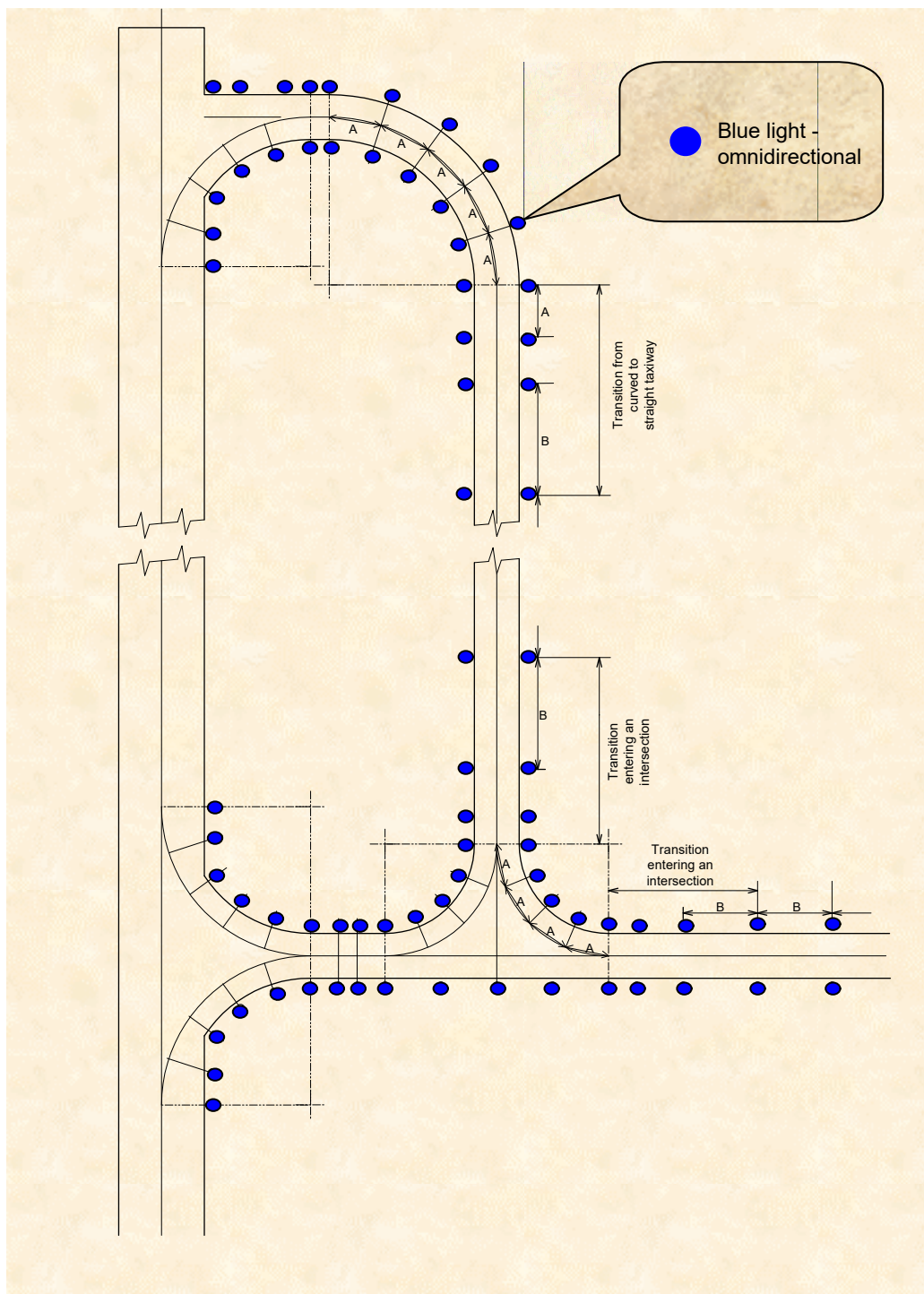
*Note* Where it appears, the abbreviation “T.P.” shows the tangent point for the purposes of the Figure.



**Figure 9.112-1 Taxiway centreline lights layout (illustrates matters)**



**Figure 9.112-2 Typical taxiway centreline lights layout (illustrates matters)**



**Figure 9.112-3 Typical taxiway edge lights layout (illustrates matters)**

## CHAPTER 9

### Division 12 Apron lights

#### 9.113 Apron floodlighting

This Division sets standards for apron floodlighting where it is provided.

*Note* ICAO establishes only one apron floodlighting standard. Australia, however, has a 3-tier system:

- (a) high illuminance standards for aprons intended to serve larger aeroplanes engaged in air transport operations; and
- (b) a mid-range illuminance standard for aprons intended to serve smaller aeroplanes engaged in air transport operations or large aircraft not engaged in air transport operations; and
- (c) a lower standard for aprons without air transport operations.

#### 9.114 Provision of apron floodlighting

- (1) Apron floodlighting must be provided on any of the following intended for use at night:
  - (a) an apron;
  - (b) a part of an apron;
  - (c) an aircraft parking position;
  - (d) a designated isolated aircraft parking position.
- (2) Subject to section 9.80, for intended operations with a runway visibility, or RVR, below 800 m, and with no taxiway centreline, taxiway edge or apron edge lights provided, apron floodlighting for an apron taxiway or taxilane must be provided in accordance with this Chapter.

#### 9.115 Location of apron floodlighting

- (1) Apron floodlighting in accordance with this Chapter must be located outside the separation distances on aprons.

*Note* For separation distances on aprons, see section 6.58.

- (2) If an apron taxiway or taxilane is not provided with taxiway lighting, then it must be illuminated by the apron floodlighting mentioned in paragraph 9.116 (3) (c).

*Note* CASA recommends that all apron taxiways used in RVR conditions less than 550 m should be provided with taxiway centreline lights.

- (3) Apron floodlights must not produce a light output which is hazardous to:
  - (a) aircraft in flight or on the ground; or
  - (b) air traffic controllers; or
  - (c) personnel on the apron.
- (4) An aircraft parking position must, as far as possible, receive apron floodlighting from 2 or more directions to minimise shadows.
- (5) Apron floodlighting poles or pylons must not infringe the obstacle limitation surfaces without written approval from CASA.

*Note 1* For apron floodlighting purposes, an aircraft parking position means a rectangular area conforming to the wingspan and overall length of the largest aircraft that is intended to occupy that position.

*Note 2* See subsection 19.01 (6) regarding line of sight requirements for controlled aerodromes and aerodromes with ARFFS facilities.

### 9.116 Characteristics of apron floodlighting

- (1) For an aerodrome accommodating scheduled international air transport operations, the apron floodlighting must be distributed across the phases of a 3-phase power supply system.

*Note* This is required to avoid a stroboscopic effect, and to minimise the chance of an illuminated rotating object, for example, a propeller, appearing stationary.

- (2) For apron floodlights:
  - (a) monochromatic lights must not be used; and
  - (b) the spectral distribution of the floodlights must be such that the colours used for the following are correctly identifiable:
    - (i) markings associated with routine aircraft servicing;
    - (ii) surface and obstacle markings.
- (3) The minimum average illuminance of an apron must be at least as follows:
  - (a) at an aircraft parking position intended for air transport operations:
    - (i) for horizontal illuminance at a parking position with an aerodrome reference code letter — a minimum lux rating in accordance with Table 9.116 (3) for the code letter, with a uniformity ratio (average to minimum) of not more than 4:1; and
    - (ii) for vertical illuminance at a parking position with an aerodrome reference code letter — a minimum lux rating in accordance with Table 9.116 (3) for the code letter, at a height of 2 m above the apron in the relevant parking direction, along the aeroplane centreline until the point where the rearmost passenger or cargo door of the intended aircraft is reached;
  - (b) at an aircraft parking position not intended for air transport operations — a minimum lux rating for horizontal illuminance in accordance with Table 9.116 (3) with a uniformity ratio (average to minimum) of not more than 4:1;
  - (c) at other apron areas — horizontal illuminance at 50% of the average minimum illuminance for the highest code for the associated parking positions on the apron, in accordance with Table 9.116 (3), with a uniformity ratio (average to minimum) of not more than 4:1.
- (4) For paragraph (3) (a), illuminance measurements at the time of commissioning and during any subsequent checks, including those made during the aerodrome technical inspection, must be taken as follows:
  - (a) for horizontal illuminance — measured with a clear line of sight to the source of apron floodlighting;
  - (b) for vertical illuminance:
    - (i) measured perpendicular to the centreline of the parked aircraft, with the lux meter facing outwards from the centreline; and
    - (ii) measured in opposing directions; and
    - (iii) with a clear line of sight to the source of apron floodlighting.

- (5) For subsection (3), for a parking position with an aerodrome reference code letter mentioned in a row of column 1 of Table 9.116 (3), the minimum parking position average illuminance for an apron intended for air transport operations, and for an apron not intended for air transport operations, respectively, is the illuminance mentioned in the same row in column 2 and column 3, respectively.
- (6) Subsection (3) does not apply for the purposes of aircraft manoeuvring if taxiway lights provide continuous guidance between the taxiway and the parking position.

*Note* The aerodrome operator may nominate a different code for each parking position. However the required illuminance for the other areas of the apron is dependent upon the highest code of parking position on the apron. This ensures the illuminance of markings associated with apron taxiways and taxilanes will be provided until the aircraft reaches the parking position.

The uniformity ratio between the average of all values of illuminance is measured over a grid covering the relevant area. This measurement is not intended only to confirm that the minimum illuminance within the parking position area has been achieved. Illuminance must also be within the 4:1 ratio mentioned in subsection 9.116 (3). For example, a 4:1 ratio does not necessarily mean a minimum of 5 lux. If an average illuminance of, for example, 24 lux is achieved, then the minimum should not be less than  $24/4 = 6$  lux.

**Table 9.116 (3) Minimum parking position illuminance**

<b>Aerodrome reference code letter for parking position</b>	<b>Minimum parking position average illuminance for aprons intended for air transport operations</b>	<b>Minimum parking position average illuminance for aprons not intended for air transport operations</b>
A	10 lux	5 lux
B	10 lux	5 lux
C	20 lux	10 lux
D	20 lux	10 lux
E	20 lux	10 lux
F	20 lux	10 lux

*Note* The ground service equipment area independent of the aprons is recommended to have a horizontal illuminance of at least 10 lux with a uniformity ratio (average to minimum) of not more than 4:1.

- (7) A dimming control:
- (a) may be provided for apron floodlighting to allow reduction in the illuminance of an aircraft parking position that is not in use; and
  - (b) must:
    - (i) ensure that the minimum floodlighting intensity for the parking position does not reduce to less than 50% of its normal value; and
    - (ii) return the parking position to the minimum average illuminance when the apron becomes active.
- (8) If apron floodlighting is activated by a PAL, the apron floodlighting must achieve normal illumination within 2 minutes of activation.

- (9) For aprons used by air transport operations, the apron floodlighting must be:
- (a) included in the aerodrome secondary power supply, if available; and
  - (b) capable of achieving not less than 50% of normal illuminance within 60 seconds of the end of a power interruption of 30 seconds or less.
- (10) If floodlights cannot meet the requirement of subsection (9), auxiliary floodlighting must be provided that can provide at least 2 lux of horizontal illuminance of aircraft parking positions. This auxiliary floodlighting must remain on until the main lighting has achieved 80% of normal illuminance.

*Note* Each floodlight design should meet a target value which allows lighting to still meet illuminance requirements in the event of commonly occurring outages. The floodlight designer may choose the factor, provided it is appropriate for the particular floodlighting system.



## CHAPTER 9

### Division 13 Aircraft parking position lighting

#### 9.117 Visual docking guidance systems

A visual docking guidance system (a *VDGS*) or an advanced visual docking guidance system (an *A-VDGS*) must be provided at an apron aircraft parking position equipped with a passenger loading bridge which requires precise positioning of an aircraft.

*Note* At international aerodromes used for air transport operations and which are equipped with a passenger loading bridge, CASA recommends the use of A-VDGS parking positions.

#### 9.118 Characteristics of visual docking guidance systems

- (1) A VDGS must provide both azimuth and stopping guidance.
- (2) For a VDGS, the azimuth guidance unit and the stopping position indicator must, both by day and by night:
  - (a) be adequate for use in all conditions of weather, visibility, background lighting and pavement for which the system is intended; and
  - (b) not present a hazard to the pilot.

*Note* Care is required in both the design and on-site installation of the system to ensure that reflection of sunlight, or other light in the vicinity, does not degrade the clarity and conspicuity of the visual cues provided by the system.

- (3) For subsection (2), the azimuth guidance unit and the stopping position indicator must be of a design such that:
  - (a) a clear indication is available to the pilot of any malfunction of the unit, or the indicator, or both; and
  - (b) the unit, or the indicator, or both can be turned off.
- (4) The azimuth guidance unit and the stopping position indicator must be located in such a way that there is continuity of guidance to the pilot as between the following:
  - (a) the aircraft parking position markings;
  - (b) the aircraft stand manoeuvring guidance lights, if present;
  - (c) the VDGS.
- (5) A VDGS must be sufficiently accurate as to provide safe tracking by an aircraft for all of the loading bridge and fixed aircraft servicing installations on the parking position.
- (6) If selective operation is required to prepare the VDGS for use by a particular type of aircraft, then the system must provide an identification of the selected aircraft type to both the pilot and the system operator as a means of ensuring that the system has been set properly.

### 9.119 Azimuth guidance unit — location

To ensure that its signals are visible from the cockpit of an aircraft throughout a docking manoeuvre, the azimuth guidance unit must be:

- (a) located on, or adjacent to, the extension of the parking position centreline ahead of the relevant aircraft; and
- (b) aligned for use:
  - (i) at least by the pilot occupying the left-hand seat; or
  - (ii) by the pilots occupying both the left-hand and right-hand seats.

### 9.120 Azimuth guidance unit — characteristics

- (1) The azimuth guidance unit must provide unambiguous left and right guidance which enables the pilot to acquire and maintain the lead-in line without over-controlling.
- (2) If azimuth guidance is indicated by colour change, then:
  - (a) green must be used to identify the centreline; and
  - (b) red must be used to identify deviations from the centreline.

### 9.121 Stopping position indicator — location

The stopping position indicator must be located in conjunction with, or sufficiently close to, the azimuth guidance unit, so that a pilot can observe both the azimuth and stop signals without turning his or her head.

### 9.122 Stopping position indicator — characteristics

- (1) The stopping position information provided by the stopping position indicator for a particular aircraft type must be visible from the intended range of variations in pilot eye height and viewing angle.
- (2) The stopping position indicator must:
  - (a) show the stopping position of the aircraft for which the guidance is being provided; and
  - (b) provide closing rate information over a distance of at least 10 m to enable the pilot to gradually decelerate the aircraft to a full stop at the intended stopping position.
- (3) If stopping guidance is indicated by colour change, then;
  - (a) green must be used to show that the aircraft may proceed; and
  - (b) red must be used to show that the stop point has been reached; and
  - (c) for a short distance before the stopping point — a third colour may be used to warn that the stopping point is close.

### 9.123 Advanced visual docking guidance system (A-VDGS)

- (1) An aerodrome operator may provide an advanced visual docking guidance system (A-VDGS) in accordance with this section.

*Note 1* Advanced visual docking guidance systems include those systems that provide pilots with active (usually sensor-based) guidance information including aircraft type confirmation, distance-to-go information and closing speed. Docking guidance information is usually provided on a single display unit.

*Note 2* CASA recommends that an A-VDGS should be provided if it is operationally desirable to confirm the correct aircraft type for which guidance is being provided and/or to indicate the stand centreline in use, if more than one is provided for.

- (2) An A-VDGS must be suitable for use by all types of aircraft for which the aircraft parking position is intended.
- (3) An A-VDGS must supply the following docking guidance information in sequence:
  - (a) the acquisition of the aircraft by the system;
  - (b) the azimuth alignment of the aircraft;
  - (c) the stopping position information.
- (4) An A-VDGS must not be used in conditions other than those specified by the manufacturer.

*Note* The use of the A-VDGS in particular conditions for example, of weather, visibility or background lighting, both by day and night, must be specified by the manufacturer.

- (5) If the following are both provided and used simultaneously on an aircraft parking position:
  - (a) an A-VDGS;
  - (b) a conventional VDGS (*conventional system*);the docking guidance information provided by the A-VDGS must not conflict with the docking guidance information provided by the conventional system.
- (6) An A-VDGS must be able to indicate whether or not it is:
  - (a) in operational use; or
  - (b) unserviceable.
- (7) An A-VDGS must be located such that, throughout a docking manoeuvre, unobstructed and unambiguous guidance is provided to:
  - (a) the person manoeuvring the aircraft; and
  - (b) each other person assisting that person.

*Note* The docking of the aircraft can be carried out from either pilot seat. However, in some circumstances, another person performing the docking manoeuvre may be the driver of a vehicle that is towing the aircraft.

### 9.124 Characteristics of an A-VDGS

- (1) An A-VDGS must provide at least the following guidance information at the appropriate stage of the docking manoeuvre:
  - (a) an emergency stop indication;
  - (b) the aircraft type and model for which the guidance is provided;
  - (c) an indication of the lateral displacement of the aircraft relative to the stand centreline;
  - (d) the direction of azimuth correction needed to correct a displacement from the stand centreline;
  - (e) an indication of the distance to the stop position;
  - (f) an indication of when the aircraft has reached the correct stopping position;
  - (g) a warning indication if the aircraft goes beyond the appropriate stop position.

- (2) An A-VDGS must be capable of providing docking guidance information for all aircraft taxi speeds used during the docking manoeuvre.

*Note* ICAO Document 9157, Aerodrome Design Manual, Part 4 — Visual Aids, provides an indication of the maximum aircraft speeds relative to distance to the stopping position. For ICAO documents, see section 1.07.

- (3) For normal operating conditions, the time taken from determination, to display, of the lateral displacement by the A-VDGS must not result in the aircraft deviating from the aircraft parking position centreline by more than 1 m.
- (4) The following information displayed by an A-VDGS:
- (a) displacement of the aircraft relative to the stand centreline;
  - (b) distance to the stopping position;

must have the accuracy specified in Table 9.124 (4) so that for the guidance information mentioned in a row of column 1 of the Table, the maximum deviation at the stop position or at a specified distance from the stop position is that given in the same row in column 2, 3, 4 or 5, as the case requires.

**Table 9.124 (4) A-VDGS displacement accuracy**

<b>Guidance information</b>	<b>Maximum deviation at stop position (stop area)</b>	<b>Maximum deviation at 9 m from stop position</b>	<b>Maximum deviation at 15 m from stop position</b>	<b>Maximum deviation at 25 m from stop position</b>
Azimuth	±0.25 m	±0.34 m	±0.4 m	±0.5 m
Distance	±0.5 m	±1.0 m	±1.3 m	N/A

- (5) If an A-VDGS uses symbols and graphics to depict guidance information, the symbols and graphics must be representative of the type of information depicted.

*Note* The use of colour should be appropriate and follow signal convention, i.e. red, yellow and green mean hazard, caution and normal/correct conditions, respectively. CASA recommends that the effects of colour contrasts should also be considered.

- (6) An A-VDGS must provide information on the lateral displacement of an aircraft relative to the stand centreline at least 25 m before the stop position.

*Note* The indication of the distance of the aircraft from the stop position may be colour-coded and presented at a rate and distance proportional to the actual closure rate and distance of the aircraft approaching the stop point.

- (7) An A-VDGS must provide continuous closure distance and closure rate from at least 15 m before the stop position.
- (8) For subsection (7), closure distance displayed in numerals must be:
- (a) in metre integers to the stop position; and
  - (b) to 1 decimal place at least 3 m before the stop position.
- (9) An A-VDGS must have the ability, at any time during a docking manoeuvre, to indicate that the aircraft must be immediately stopped, by:
- (a) displaying the word STOP in red characters; and
  - (b) not displaying any other information.

*Note* Reasons for indication of an immediate halt include, for example, a failure of the A-VDGS.

- (10) An A-VDGS must allow any person responsible for the operational safety of the aircraft parking position to initiate an immediate stop to a docking procedure if required in the interests of safety.

### **9.125 Aircraft parking position manoeuvring guidance lights**

- (1) Aircraft parking position manoeuvring guidance lights (the *lights*) may be provided to facilitate the positioning of an aircraft on an aircraft parking position on a paved apron if the parking position is intended for use in RVR conditions less than 550 m.
- (2) The lights must be co-located with the aircraft parking position markings.
- (3) The lights, other than those indicating a stop position, must be as follows:
  - (a) fixed yellow lights;
  - (b) visible throughout the taxi manoeuvre for which they are intended to provide guidance.
- (4) The lights used to delineate lead-in, turning and lead-out lines must be spaced at intervals of not more than 7.5 m on curves and 15 m on straight sections.
- (5) The lights indicating a stop position must be fixed unidirectional lights showing red.
- (6) The lighting circuit for the lights must be designed so that the lights can be switched on to indicate that an aircraft parking position is to be used, and switched off to indicate that it is not to be used.

### **9.126 Parking position identification signage**

- (1) An aircraft parking position that is equipped with a VDGS or an A-VDGS must have a parking position identification sign.
- (2) The parking position identification sign must be located so as to be clearly visible from the cockpit of an aircraft before the aircraft enters the parking position.
- (3) The parking position identification sign must consist of a numeric or alphanumeric inscription that is:
  - (a) in white on a black background; or
  - (b) in black on a yellow background.
- (4) For an aircraft parking position intended for use at night, the parking position identification sign must be illuminated at night by:
  - (a) a continuous line of green or white light that outlines the inscription and is clearly visible to pilots; or
  - (b) direct or ambient lighting which illuminates the sign face and is clearly visible to pilots.
- (5) The illumination under subsection (4) must not create a hazard to pilots or ground personnel.

## CHAPTER 9

### Division 14 Works and unserviceable area lighting

#### 9.127 Lighting associated with closed and unserviceable areas

- (1) If a runway or taxiway, or a portion of a runway or taxiway, is closed (a *closed facility*), all aerodrome lighting on the closed facility, and any visual aids leading a pilot into the closed facility, must be extinguished or obscured except the lighting for visual aids used to warn pilots of the closed facility.
- (2) Subject to subsection (1), the restricted operation of visual aids is permissible for maintenance or related purposes.
- (3) For a partial or complete closure of a manoeuvring area for less than 5 days, the aerodrome lights for the closed area must be:
  - (a) obscured with an opaque cover that is as follows:
    - (i) firmly attached to the ground so that it cannot be unintentionally dislodged;
    - (ii) lightweight and frangible, and not otherwise posing a hazard to aircraft; or
  - (b) if not so obscured — electrically isolated or disabled to prevent their inadvertent activation.
- (4) For a partial or complete closure of a manoeuvring area for 5 days or more the aerodrome lights for the closed area must be electrically isolated or disabled to prevent their inadvertent activation.

#### 9.128 Lighted visual aid to indicate a temporary complete runway closure

- (1) For a temporary unserviceability of the normal runway length, a lighted visual aid may be used at controlled aerodromes as follows:
  - (a) to supplement the extinguishing or obscuring of runway lighting;
  - (b) in-lieu of day time markings for runway closures of less than 24 hours duration;
  - (c) in conjunction with unserviceability markings as described in section 8.106.

*Note* The aid must be in the form of a lit cross — see section 9.129.
- (2) The lighted visual aid must not be used:
  - (a) for partial closures or partial unserviceability of the normal runway length; or  
*Note* Lighted visual aids are intended to be used for unserviceability.
  - (b) in conjunction with temporarily displaced threshold markings or lights; or
  - (c) at non-controlled aerodromes; or
  - (d) at controlled aerodromes during such times as Air Traffic Control services are not available.
- (3) The lighted visual aid must be:
  - (a) positioned within the permanent threshold of the runway at each end; and
  - (b) as far as possible — aligned with the runway centreline.

- (4) Additional lighted visual aids to indicate the temporary runway unserviceability may be located and spaced as required for runway unserviceability markings.

*Note* For runway unserviceability markings, see, relevantly, subsections 8.106 (2) and (3).

### **9.129 Characteristics of a lighted visual aid to indicate a temporary complete runway closure**

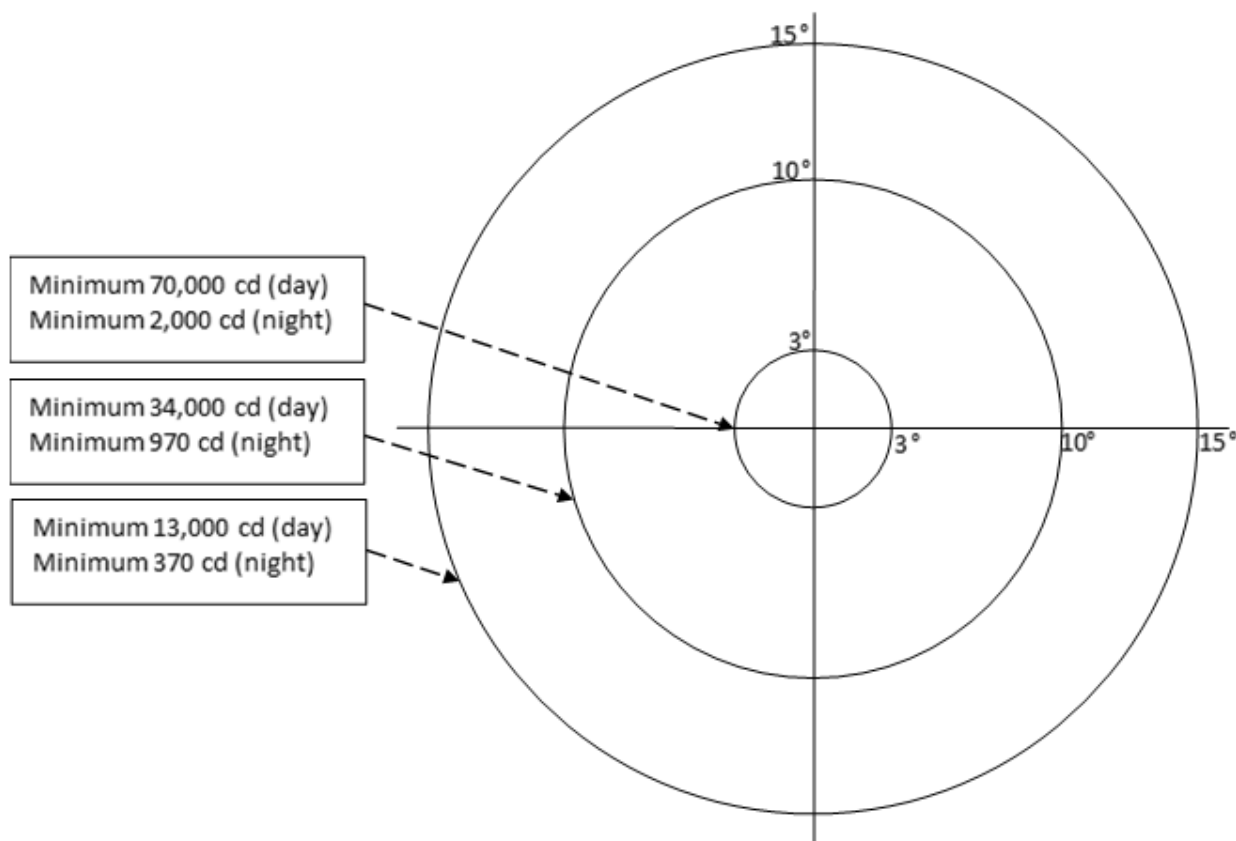
- (1) For section 9.128, the lighted visual aid must consist of an X-shaped cross with 2 lit arms.
- (2) For subsection (1), the arms of the X-shaped cross must:
- (a) each be at least 6 m in length; and
  - (b) intersect at their midpoint (the *intersection point*):
    - (i) at a preferred internal angle of 90 degrees; or
    - (ii) so that a distinct X shape is discernible to the pilot of an aircraft:
      - (A) in the air on approach to the runway; and
      - (B) on the ground manoeuvring on the runway; and
  - (c) be deployed such that:
    - (i) the cross is vertical and positioned at right angles to the runway centreline; and
    - (ii) each arm of the cross is at 45 degrees to the horizontal; and
  - (d) have a light source coloured white, consisting of:
    - (i) individual lamps or lights, facing the direction of the approach to the runway, and located as follows:
      - (A) 1 — at the outer extremity of each lit arm;
      - (B) others — evenly between the outer and inner extremities at intervals no greater than 1 m;
      - (C) 1 — at the centre of the intersection point; or
    - (ii) a light bar which completely illuminates the full length of each lit arm to a minimum width of 0.3 m; and
  - (e) in combination, provide a minimum day effective intensity, as illustrated in Figure 9.130 (1), of:
    - (i) 70 000 cd at the beam centre; and
    - (ii) 34 000 cd at 10 degrees radius from the beam centre; and
    - (iii) 13 000 cd at 15 degrees radius from the beam centre; and
  - (f) in combination, provide a minimum night effective intensity, as illustrated in Figure 9.130 (1), of:
    - (i) 2 000 cd at the beam centre; and
    - (ii) 970 cd at 10 degrees radius from the beam centre; and
    - (iii) 370 cd at 15 degrees radius from the beam centre.

- (3) For subsection (2), the light source must be from a portable or mains power supply that ensures:
  - (a) continuous operation of lighting for the lighted visual aid; and
  - (b) simultaneous illumination of all relevant lamps, lights or bars at between 15 and 30 cycles per minute with a one second maximum OFF-time.
- (4) The lighted visual aid must be designed and constructed to be capable of being:
  - (a) deployed within 15 minutes of being positioned on the runway; and
  - (b) removed from the runway within 15 minutes.
- (5) If the lighted visual aid is used in periods of low visibility, in addition to complying with subsection (3), it must also meet the secondary power supply requirements of section 9.05.
- (6) If the lighted visual aid is located on the runway during periods of daylight, the surface of the aid facing the pilot must be:
  - (a) coloured yellow; or
  - (b) obstacle marked in accordance with section 8.111; or
  - (c) otherwise illuminated.

### **9.130 Isocandela diagram for lighted visual aid to indicate temporary runway closure**

- (1) For a lighted visual aid to indicate a temporary complete runway closure:
  - (a) Figure 9.130 (1) illustrates the required beam pattern; and
  - (b) the minimum intensity of the main beam pattern is to be calculated by:
    - (i) establishing grid points with reference to the main beam as illustrated in Figure 9.130 (1); and
    - (ii) using the intensity values, as specified in paragraphs 9.129 (2) (e) and (f) within and on the perimeter of the circles representing the main beam pattern; and
    - (iii) using the arithmetic average of the light intensities measured at all the considered grid points to resolve the average value.
- (2) There must be no deviations in the main beam when the lighting fixture is properly aimed.
- (3) Vertical angles must be measured from the longitudinal slope of the runway surface.
- (4) The light unit must be installed so that the main beam is aligned within 0.5 degrees of the specified requirement.
- (5) On the perimeter of, and within, the circle defining the main beam, the maximum light intensity value must not exceed the lessor of:
  - (a) 3 times the minimum light intensity so measured; or
  - (b) the limit at which the light intensity would otherwise dazzle or distract a pilot during the expected ambient light and visibility conditions in which the lighted visual aid is intended to be used.





**Figure 9.130 (1) Beam pattern diagram for lighted visual aid to indicate a temporary runway closure (illustrates matters)**

### 9.131 Movement area access in the vicinity of unserviceable areas

- (1) If a closed runway or taxiway, or a portion of a closed runway or taxiway (the **closed area**) is intersected by a runway or taxiway which is used at night, unserviceability lights must be placed across the entrance to the closed area at intervals not exceeding 3 m.
- (2) If:
  - (a) any portion of a taxiway, an apron or a holding bay is unfit for the movement of aircraft (the **unserviceable area**); and
  - (b) it remains possible for an aircraft to safely bypass the unserviceable area; and
  - (c) the movement area is used at night;

then unserviceability lights, not more than 7.5 m apart, must clearly delineate the unserviceable area.

### 9.132 Characteristics of unserviceability lights

Unserviceability lights must:

- (a) be steady red lights; and
- (b) have:
  - (i) an intensity that is sufficient to ensure conspicuity considering the intensity of the adjacent lights and the general level of illumination against which they would normally be viewed; and
  - (ii) an average output of red main beam light not less than 10 cd.

## CHAPTER 9

### Division 15 Other lights on an aerodrome

#### 9.133 Works limit lights

- (1) An aerodrome operator may provide works limit lights to delineate the limit of the works area for persons associated with the works organisation.
- (2) Works limit lights must be portable and coloured amber, yellow or orange.
- (3) A works limit light must have a light output that is clearly visible to a pilot approaching the works area but not so great that it creates a hazard.

*Note* Works limit lights are typically available as a standard type fitting which is commercially available as works warning lights. Alternatively, liquid fuel lanterns with amber, yellow or orange coloured lenses may be suitable.

#### 9.134 Road and car park lighting

RESERVED

*Note* CASA does not regulate the lighting of roads and car parks, other than ensuring compliance with section 9.143. If road and car park lighting is required on an aerodrome, the aerodrome operator is advised to consult with the relevant local roads authority or Australian Standard AS 1158.1.1 and 1158.1.2, as in force or existing from time to time.

#### 9.135 Road-holding position light

- (1) For a runway intended to be used in visibility or RVR conditions less than 350 m, any road-holding position serving the runway must have a road-holding position light.
- (2) A road-holding position light must:
  - (a) conform to the standards specified in ICAO Annex 14, Aerodromes, Volume 1, Aerodrome Design and Operations (the *standards*); or
  - (b) be capable of demonstrating an outcome equivalent to that of light which does conform to the standards.

*Note* For ICAO documents, see section 1.07.

## CHAPTER 9

### Division 16 Monitoring, maintenance and serviceability of aerodrome lighting

#### 9.136 General

- (1) The aerodrome operator must frequently and regularly monitor and maintain all lights and lighting systems associated with the aerodrome day and night visual ground aids to ensure that they are correct and easily seen.

*Note* For aerodromes without scheduled air transport operations, weekly monitoring would be frequent and regular unless a specific reason gave rise to the need for sooner monitoring than weekly.

- (2) Subject to subsection (3), aerodrome lights must be:
  - (a) monitored during the daily serviceability inspection; and
  - (b) switched on for the purpose of monitoring.
- (3) T-VASIS, PAPI and approach lighting must be monitored in accordance with the frequencies and procedures set out in the aerodrome operator's aerodrome manual.
- (4) Grass areas around lights must be maintained to ensure that the lights:
  - (a) are not in any way obscured; and
  - (b) are free from dirt that could degrade a light's colour and conspicuity.
- (5) Damage to lights, including loss or degradation of lights, must be repaired as soon as possible.

#### 9.137 Reporting of aerodrome lighting outage

- (1) An aerodrome lighting system or facility experiencing a lighting outage (*on outage*) must be fixed as soon as possible after the outage is detected.

*Note* The specifications listed below are intended to define the maintenance performance level objectives. They are not intended to define whether the lighting system is operationally out of service. Nor are they meant to condone outage, but are intended to indicate when lighting outage must be notified to the NOTAM Office.

- (2) The specifications in subsections (3), (4) and (5) must be used as triggers for NOTAM action to advise pilots of actual outage, unless the outage can be rectified before the next period of the light's use.
- (3) A light is deemed to be in a failed stated (unserviceable) if:
  - (a) the main beam is out of its specified alignment; or
  - (b) the main beam average intensity is less than 50% of the specified value; or
  - (c) for light units with the designed main beam average intensity above the specified value — the 50% value must be correlated to the design value; or
  - (d) a deterioration of the light signal is detectable to the human eye.
- (4) A flashing light is deemed to be on outage if:
  - (a) the light ceases to flash; or
  - (b) the frequency or duration of flash is outside the specified range by a ratio equal to or greater than 2:1; or
  - (c) within a 10 minute period — more than 20% of flashes fail to occur.

*Note* Flashing lights also include LAHSO lights, which have a slow flash rate.

- (5) A lighting system is deemed to be on outage if:
- (a) for a lighting system comprising less than 4 lights (for example, intermediate holding position lights or runway threshold identification lights) — any of the lights is unserviceable; and
  - (b) for a lighting system comprising 4 or 5 lights (for example wind direction indicator lights or runway guard lights) — 2 or more lights are unserviceable; and
  - (c) for a lighting system comprising 6 to 13 lights (for example threshold lights or LAHSO lights) — 3 or more lights, or 2 or more adjacent lights, are unserviceable; and
  - (d) for a precision approach CAT II or CAT III runway:
    - (i) more than 5% of the lights are unserviceable in any of the following elements:
      - (A) the inner 450 m of the approach lighting system;
      - (B) the runway centreline lights;
      - (C) the runway threshold lights;
      - (D) the runway edge lights; or
    - (ii) more than 10% of the lights are unserviceable in the touchdown zone lights; or
    - (iii) more than 15% of the lights are unserviceable in the approach lighting system beyond 450 m; or
    - (iv) in any case other than a barrette or a crossbar — 2 or more adjacent lights are unserviceable; or
    - (v) for a barrette or a crossbar — 3 or more adjacent lights are unserviceable; and
  - (e) in the case of a runway meant for take-off in visibility or RVR conditions less than 550 m:
    - (i) more than 5% of the lights are unserviceable in any of the following elements:
      - (A) centreline lights (if provided);
      - (B) runway edge lights; or
    - (ii) 2 or more adjacent lights are unserviceable; and
  - (f) in the case of a taxiway intended for use in visibility or RVR conditions less than 350 m, 2 or more adjacent taxiway centreline lights are unserviceable; and
  - (g) in the case of any other lighting system with more than 13 lights:
    - (i) more than 15% of the lights are unserviceable; or
    - (ii) 2 or more adjacent lights are unserviceable.
- (6) In the calculation of a percentage of lights specified in a provision of subsection (5), any fractional number must be rounded up.

*Note* For subsection (5), a lighting system means lights used to illuminate a particular aerodrome facility, for example:

- (a) all of the lights used to mark a threshold; or
- (b) all of the lights used to mark a runway end; or
- (c) all of the runway edge lights on a runway; or
- (d) all of the taxiway centreline lights on a length of taxiway between intersections.

### 9.138 Standards for apron lighting unserviceability

- (1) An aircraft parking position lighting system is deemed to be unserviceable if:
  - (a) the average horizontal illuminance falls below 50% of the associated minimum lux rating in accordance with that shown in Table 9.116 (3); or
  - (b) the average horizontal illuminance exceeds the maximum uniformity ratio (average to minimum) of not more than 8:1; or
  - (c) the average vertical illuminance falls below 50% of the associated minimum lux rating in accordance with Table 9.116 (3), as applicable; or
  - (d) in low-visibility conditions:
    - (i) 2 or more adjacent aircraft parking position manoeuvring guidance lights are unserviceable; and
    - (ii) there is inadequate illumination available from the apron floodlighting; or
  - (e) the average illuminance in paragraph 9.116 (3) (a) is not restored within 60 seconds in the event of a power failure to the associated apron floodlighting.
- (2) An apron lighting system is deemed to be unserviceable if:
  - (a) illumination of the apron outside the parking position falls below the minimum intensity specified in paragraph 9.116 (3) (c) (but subject to subsection 9.116 (4)); or
  - (b) in low-visibility conditions, the taxiway centreline lights, or the apron floodlighting system, does not provide illumination for the taxiway markings.

*Note* For apron floodlighting, the unserviceability standards take into account the reduction in illuminance on the apron edge taxiway, apron taxilane and aircraft parking position, or the presence of shadows, due to a lighting failure.

### 9.139 T-VASIS standards for unserviceability

- (1) A T-VASIS light unit is deemed unserviceable if:
  - (a) 3 or more lamps in the electrical (day) circuit are unserviceable; or
  - (b) any of the lamps in the electrical (night) circuit is unserviceable.
- (2) A T-VASIS is deemed unserviceable if:
  - (a) for bar units — 3 or more light units, or 2 or more adjacent light units, are unserviceable;
  - (b) for fly-up units — 2 or more light units are unserviceable;
  - (c) for fly-down units — 1 or more light units are unserviceable.

*Note* For a T-VASIS, the outage standards take into account both the number of outage lamps within a light unit, and also the number of light units within the T-VASIS.

- (3) An AT-VASIS is deemed unserviceable if:
  - (a) for bar units — 2 or more light units are unserviceable; or
  - (b) subject to paragraph (d), for fly-up units — any light unit is unserviceable; or
  - (c) subject to paragraph (d), for fly-down units — any light unit is unserviceable; or

- (d) a red filter has deteriorated such that it does not produce the correct colour light beam, is missing, or is damaged.
- (4) For paragraph (3) (d):
- (a) all the lamps within the affected light unit must be extinguished until the red filter is rectified; and
  - (b) the affected light unit must be considered to be an unserviceable light unit for paragraph (3) (b) or (3) (c).

### 9.140 PAPI unserviceability standards

*Note* For a PAPI, the unserviceability standards take into account both the number of lamps on outage within a light unit and also the number of light units within the PAPI.

- (1) A single-sided PAPI is deemed to be unserviceable if:
  - (a) subject to paragraph (c), any lamp in a 2 or 1 lamp light unit is unserviceable; or
  - (b) 2 or more lamps in a 3 or more lamp light unit is unserviceable; or
  - (c) for a red filter — 1 or more of the following has occurred, namely, that the filter:
    - (i) has deteriorated to such a degree that it does not produce the correct colour light beam;
    - (ii) is missing;
    - (iii) is damaged.
- (2) For paragraph (1) (c):
  - (a) all the lamps associated with the red filter must be extinguished until the red filter is rectified; and
  - (b) the affected lamp or lamps must be considered to be unserviceable lamps when applying paragraph (1) (a) above.
- (3) A PAPI must be extinguished until the unserviceability in the system is rectified.
- (4) A double-sided PAPI with 8 light units is deemed to be unserviceable if all light units in one wing bar are fully functioning, and any light units in the other wing bar are unserviceable.
- (5) For subsection (4), the PAPI may remain in use if a NOTAM sets out:
  - (a) the number of unserviceable light units; and
  - (b) which side of the runway is affected.
- (6) A double-sided PAPI with 8 light units is deemed to be unserviceable if one or more light units in each wing bar is unserviceable.
- (7) An unserviceable double-sided PAPI must be extinguished until the unserviceability is rectified.

### 9.141 Interleaved circuitry

A lighting system serviced by interleaved circuitry is deemed to be unserviceable if any 1 of the circuits fails.

### 9.142 Movement area guidance signs

For a movement area guidance sign (MAGS):

- (a) the sign must be legible at all times; and
- (b) any lamp unserviceability in a sign must be fixed as soon as possible.

*Note 1* No specific standard is specified for a critical number of unserviceable lamps in an illuminated MAGS. The key requirement is the legibility of the sign inscription at all times.

*Note 2* The failure of MAGS illumination is not subject to notification by NOTAM.

### 9.143 Other lighting on the aerodrome

- (1) This section applies only to lights that are not otherwise provided as visual aids to aircraft under the other provisions of this MOS.
- (2) The following requirements must be complied with:
  - (a) an aerodrome operator must notify CASA in writing as soon as possible after becoming aware that a person is installing or proposing to install, or is using or is proposing to use, any installation, equipment or laser, outside the aerodrome boundary, that has or may have lighting or lighting intensity greater than that specified in Figure 9.144 (2);
  - (b) CASA must:
    - (i) consider whether the notification identifies a risk to the safety of aviation; and
    - (ii) if necessary, issue directions for action to mitigate the risk.

*Note* For directions, see regulation 94 of CAR, and regulation 11.245 of CASR.

- (3) An aerodrome operator must immediately notify CASA in writing if the operator proposes to install or use any installation, equipment or laser, inside the aerodrome boundary, that has or may have lighting or lighting intensity greater than that specified in Figure 9.144 (2).
  - (4) An aerodrome operator must not proceed with the installation or use of any installation, equipment or laser mentioned in subsection (3) until CASA has assessed, and approved in writing, the proposed lighting intensity of the installation, equipment or laser.
  - (5) An aerodrome operator must immediately notify CASA in writing of any proposals to install or use any installation, equipment or laser within the aerodrome boundary which will have any of the following kinds of lighting:
    - (a) multiple light colours emitting from a single source;
    - (b) rapid changes in light colour;
    - (c) flashing lights.
- Note* Coloured lights, flashing lights or lasers may cause a hazard to aircraft operations irrespective of their intensity.
- (6) An aerodrome operator must not proceed with any proposal mentioned in subsection (5) until CASA has assessed, and approved in writing, the lighting intensity proposed for the installation, equipment or laser.
  - (7) Subsections (3), (5) and (6) do not apply to the following:
    - (a) visual aids required for aircraft operations;
    - (b) signalling equipment;



- (c) visual aids required for road safety.
- (8) An aerodrome operator must immediately notify CASA in writing of any proposals for equipment or lighting installation within the aerodrome boundary which would reflect sunlight, including solar panels, mirrors or reflective building cladding.
- (9) An aerodrome operator must not proceed with any proposal mentioned in subsection (8) unless CASA has determined, in writing, that it will not cause a hazard to aircraft operations.
- (10) CASA may direct the aerodrome operator, in writing, that an installation, equipment, laser or reflective source within the aerodrome boundary must be modified, shielded, or extinguished to ensure aviation safety.

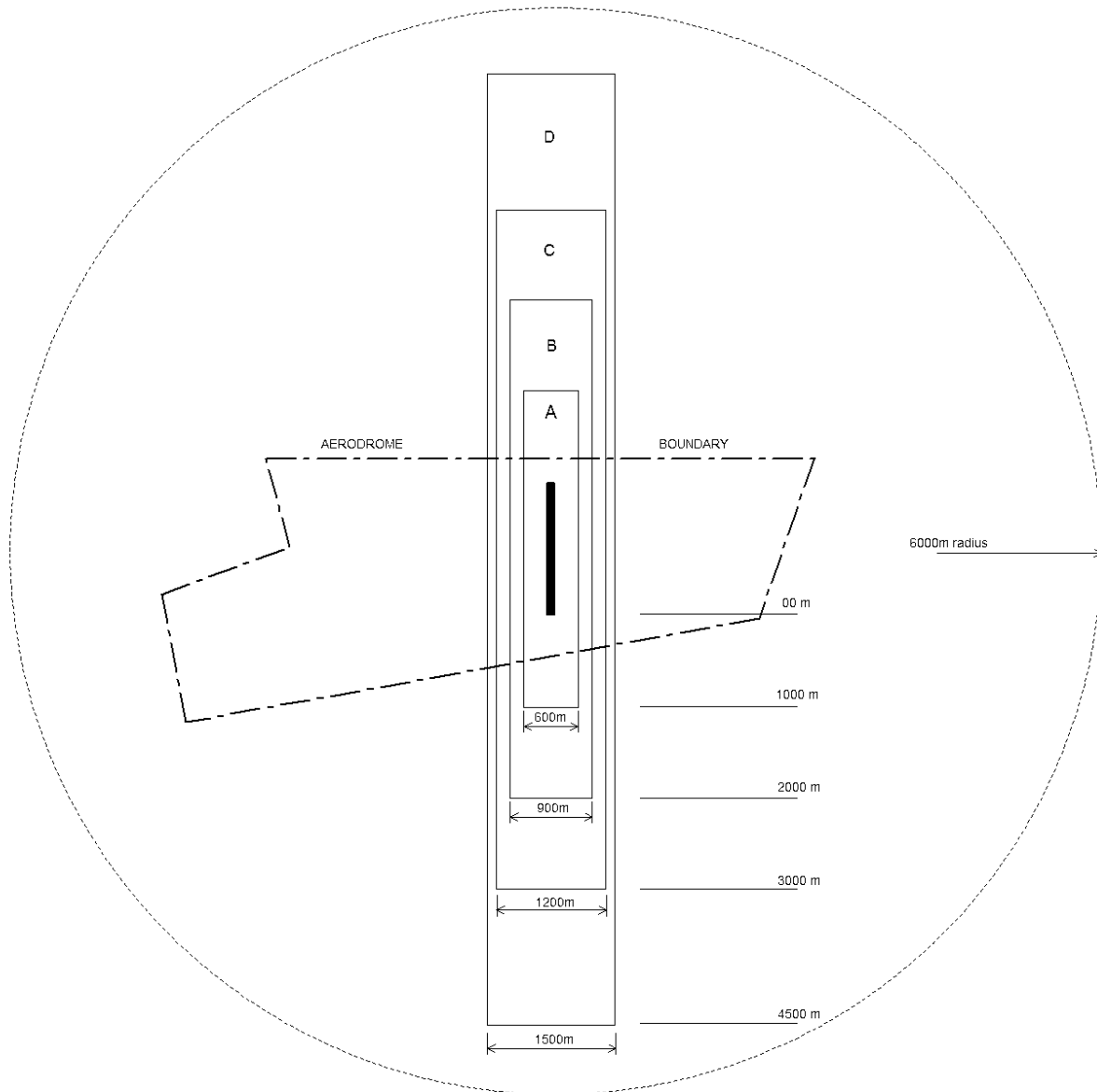
*Note* Certain lights might cause confusion, distraction or glare to pilots in the air. Ground lights may cause confusion or distraction by reason of their colour, position, pattern or intensity of light emission above the horizontal plane. Under regulation 94 of the CAR, CASA may issue notices about dangerous lights and it is an offence to fail to comply with any directions in a notice.

#### **9.144 Lights — requirements for zones**

- (1) This section does not apply to the lights mentioned in paragraphs 9.143 (7) (a), (b) and (c).
- (2) Lights installed at an aerodrome must comply with the zone requirements as shown in Figure 9.144 (2).

MAXIMUM INTENSITY OF LIGHT  
SOURCES MEASURED AT 3°  
ABOVE THE HORIZONTAL

ZONE A	0 cd
ZONE B	50 cd
ZONE C	150 cd
ZONE D	450 cd



**Figure 9.144 (2) Zone requirements for lighting (shows matters)**

*Note* In many cases the polar diagrams published by manufacturers do not show sufficient detail in the sector near the horizontal and further information may need to be requested.

For installations where the light fitting does not meet the zone requirements, a screen may be used to limit light emission to zero above the horizontal.

## CHAPTER 10 AERODROME MANUAL

### 10.01 Requirement for an aerodrome manual

- (1) The operator of a certified aerodrome must have a manual (*aerodrome manual* or *manual*) that complies with the requirements set out in this MOS.  
*Note* See Subpart 139.C.1 of CASR.
- (2) The aerodrome operator must operate the aerodrome in accordance with the procedures set out in the aerodrome manual unless a temporary non-compliance or deviation is necessary to ensure the safety of aircraft, aircraft operations or individuals using the aerodrome.
- (3) If a temporary non-compliance or deviation is required to remain permanently in place, the aerodrome manual must be amended as soon as reasonably practicable to reflect the permanent change.
- (4) The aerodrome operator must nominate one or more persons or positions to be functionally responsible for reviewing, maintaining, amending and controlling the aerodrome manual, and ensuring compliance with this Chapter.

### 10.02 Form, contents and updating of the aerodrome manual

- (1) The aerodrome manual must be:
  - (a) in a format that can be readily updated; and
  - (b) kept up-to-date.
- (2) The aerodrome manual must be kept at the premises of the aerodrome operator and made available to CASA for inspection upon written or oral request.
- (3) The aerodrome manual must contain at least all of the information required by this MOS to be in an aerodrome manual that is relevant to the aerodrome operator's operations.
- (4) If information required by this MOS to be in an aerodrome manual is not relevant to the aerodrome operator's operations, the aerodrome manual must contain a distinct placeholder for the information which:
  - (a) uses the heading "NOT APPLICABLE" or "N/A"; and
  - (b) identifies the MOS requirement by reference to the relevant provision of the MOS.
- (5) Without affecting subsections (3) and (4), the contents of the aerodrome manual may be in a different order or structure to the order or structure used in this MOS to provide for aerodrome manual requirements.
- (6) The aerodrome manual may be in:
  - (a) a hard copy; or
  - (b) electronic form; or
  - (c) a combination of hard copy and electronic form provided that the manual is conveniently accessible and usable in such a combined form.
- (7) If the aerodrome manual is in electronic form, the means of transmittal, storage, retrieval and display must be maintained in a way that ensures that the manual is conveniently accessible and usable to aerodrome personnel at all times during normal hours of aerodrome operation.

### 10.03 Version control and changes to an aerodrome manual

- (1) The aerodrome manual must be maintained in a form that allows the reader to readily see the following:
  - (a) if the manual has a version number — the up-to-date version number;
  - (b) the date of release for each section or page of the manual;
  - (c) what changes or amendments have been made, if any, from the previous amendment or version.
- (2) Details of any change to the aerodrome manual must be in the form of:
  - (a) tracked changes to the document in which the changed information:
    - (i) is shown in a different format to the unchanged information; and
    - (ii) includes reference to the date on which the change was made; or
  - (b) a table of current pages or sections which includes a written summary of each change and the date on which the change was made; or
  - (c) another means which clearly illustrates the location, date and nature of the change.
- (3) If the aerodrome operator changes the contents of the aerodrome manual, the operator must, within 30 days of the amendment being made, give CASA:
  - (a) written notice of the change; and
  - (b) a copy of the changed part of the aerodrome manual clearly identifying the change.

### 10.04 Application or adoption of other material by the aerodrome manual

- (1) The aerodrome manual may apply or adopt, as subsidiary materials, other manuals, plans, standard operating procedures, databases, files, data, lists or systems, provided that the manual clearly references the subsidiary materials as having been applied or adopted.
- (2) For subsection (1):
  - (a) the initial application or adoption of subsidiary materials must be treated as a change to the manual; and

*Note* After initial application or adoption of subsidiary materials, the application or adoption of later versions need not be treated as a change to the manual.
  - (b) the subsidiary materials must be maintained in an up-to-date form; and
  - (c) the aerodrome operator must comply with any procedures in the subsidiary materials; and
  - (d) an operator may supply CASA with copies of the subsidiary materials but is not obliged to do so unless CASA makes a written request for the materials.

## CHAPTER 11 INFORMATION THAT MUST BE INCLUDED IN THE AERODROME MANUAL

### 11.01 Aerodrome information

- (1) The information specified in Chapter 5 of this MOS for reporting in the aerodrome manual must be recorded in the manual in accordance with the relevant requirements of Chapter 5.
- (2) The following information about the aerodrome site must be recorded in the aerodrome manual:
  - (a) a scaled plan of the aerodrome showing:
    - (i) the movement area; and
    - (ii) each wind direction indicator; and
    - (iii) the aerodrome boundary; and
    - (iv) each visual approach slope indicator system (if installed); and
    - (v) each approach lighting system (if installed);
  - (b) a plan of any aerodrome facilities or equipment owned by the aerodrome operator but located outside the boundaries of the aerodrome;
  - (c) the nominated aerodrome reference code letter and number and OMGWS for all runways and taxiways, including taxilanes as applicable;
  - (d) the instrument classification of each runway.
- (3) The following information must be recorded in the aerodrome manual:
  - (a) details of any approvals, determinations, directions, exemptions or other instruments issued to the aerodrome operator by CASA;
  - (b) details of each aerodrome facility that does not comply with particular requirements of this MOS because of the operation of Chapter 2;  
*Note* These are non-compliant grandfathered facilities.
  - (c) particulars of any condition to which the aerodrome certificate is subject;
  - (d) the matters mentioned in subsection 1.08 (4).

*Note* These are matters in relation to explaining non-compliance with a preferred matter, thing or value.

### 11.02 Aerodrome administration

The following information must be included in the aerodrome manual:

- (a) particulars of the management and administration of the aerodrome, including the following:
  - (i) the organisational structure;
  - (ii) the management positions responsible for the operation and maintenance of the aerodrome, including the accountable manager;
- (b) details of the individuals or positions responsible for aerodrome manual control;
- (c) details of the individuals or positions responsible for aerodrome operations and safety functions as required by this MOS.

### 11.03 Aerodrome serviceability inspections

- (1) The aerodrome manual must contain the procedures for carrying out aerodrome serviceability inspections (*inspections*), including details of the procedures for the following:
  - (a) carrying out the inspections during and after working hours including;
    - (i) the normal schedule or timing of the inspections; and
    - (ii) the conduct of additional inspections following an incident, accident or adverse weather event;
  - (b) both:
    - (i) conducting particular inspections, including the items to be inspected or checked; and
    - (ii) making changes to the RWYCC and runway surface contaminant types;
  - (c) reporting the results of inspections;
  - (d) taking prompt follow-up action to ensure the correction of any unsafe conditions at the aerodrome;
  - (e) triggering a technical inspection of a facility if an unsafe condition is identified during a serviceability inspection;
- (2) The aerodrome manual must identify the positions in the organisational structure that are responsible for:
  - (a) managing the inspections; and
  - (b) carrying out the inspections; and
  - (c) reporting the results of the inspections; and
  - (d) taking follow-up action if an unsafe condition is identified during the inspections.

*Note* For technical inspections, see section 11.10 of this MOS.

(f) maintaining inspection records;

(g) the arrangements for communicating with ATC during the inspections, if applicable.

*Note* The requirements for a serviceability inspection and a technical inspection are specified in Chapter 12 of this MOS.

### 11.04 Aerodrome lighting

- (1) The aerodrome manual must contain the procedures for the following:
  - (a) the inspection and maintenance of the aerodrome lighting (including obstacle lighting that is maintained by the aerodrome operator);
  - (b) monitoring the supply of secondary and stand-by power (if any);
  - (c) carrying out inspections and checks, including the items to be inspected or checked;
  - (d) maintaining the records of inspections and taking follow-up action to correct deficiencies;
  - (e) switching lights on and off, including intensity selection (if applicable) and back-up arrangements for a pilot-activated lighting system (PAL);

- (f) carrying out routine maintenance and emergency maintenance;
  - (g) dealing with partial or total power system failure through secondary power, stand-by power or other means;
  - (h) monitoring hazardous lights, lasers, and reflection or glare within the aerodrome boundary.
- (2) The aerodrome manual must identify the individuals or positions responsible for the following:
- (a) carrying out the lighting inspections;
  - (b) maintaining the records of the inspections;
  - (c) taking follow-up action if an unsafe condition is identified during an inspection;
  - (d) operating aerodrome lighting, including switching systems, back-up supply systems and portable lighting equipment;
  - (e) performing maintenance of aerodrome lighting;
  - (f) monitoring of hazardous lights, lasers, and reflection or glare within the aerodrome boundary.

### **11.05 Aerodrome reporting**

- (1) The aerodrome manual must contain the procedures for notifying the following through aerodrome reports:
- (a) the AIS provider of any changes to the aerodrome information published in the AIP as required under Part 175 of CASR;
  - (b) the NOTAM Office of any change to the condition of an aerodrome facility as required under Part 175 of CASR;
  - (c) the NOTAM Office of any hazards that may adversely affect aviation safety;
- Note* The procedures for notifications to the NOTAM Office are available from Airservices Australia.
- (d) at controlled aerodromes — ATC of any hazards that may adversely affect aviation safety;
  - (e) ATC, AIS and pilots of relevant RWYCC and runway surface descriptions.
- (2) The aerodrome manual must contain the procedures for ensuring that each notification in the form of an aerodrome report:
- (a) remains in the safe custody of the aerodrome operator for at least 3 years after the report was created; and
  - (b) is readily accessible to the operator and to the persons identified under subsection (3).
- (3) The aerodrome manual must identify the individuals or positions responsible for making the aerodrome reports.

### **11.06 Obstacle control**

- (1) The aerodrome manual must contain the following:
- (a) the procedures for monitoring:
    - (i) the take-off, approach and transitional surfaces for obstacles; and

- (ii) the visual segment surface and critical obstacles associated with any published terminal instrument flight procedures at the aerodrome;
  - (b) charts published by the aerodrome operator, including the Type A chart take-off surface (if applicable);
  - (c) the height of buildings, structures, plumes and other developments within the aerodrome vicinity for infringements into the:
    - (i) obstacle limitation surface; and
    - (ii) surfaces or areas associated with any published terminal instrument flight procedures at the aerodrome (as defined in PANS-OPS);
  - (d) in the event of a proposed or actual infringement being identified — the arrangements for notifying:
    - (i) CASA concerning the obstacle limitation surface; and
    - (ii) the designer of the terminal instrument flight procedure;
  - (e) for proposed or actual infringements identified within the aerodrome boundary — the arrangements for implementing obstacle control;
  - (f) for proposed or actual infringements identified outside the aerodrome boundary — the arrangements for liaising with the relevant planning authorities and proponents to facilitate obstacle control wherever possible.
- (2) The aerodrome manual must identify the individuals or positions responsible for the following:
- (a) monitoring surfaces related to the obstacle limitation surface and the terminal instrument flight procedures (as defined in PANS-OPS);
  - (b) notifying CASA or the designer of the terminal instrument flight procedure for paragraph (1) (d);
  - (c) implementing obstacle control within the aerodrome boundary;
  - (d) liaison and facilitation of obstacle control outside the aerodrome boundary.

### **11.07 Aerodrome works safety**

- (1) The aerodrome manual must contain the procedures for planning, and safely carrying out, aerodrome works (whether or not time-limited or emergency works), including details of the procedures for the following:
- (a) the preparation of a method of working plan, including particular procedures to ensure safety standards are met;
  - (b) notifying aircraft operators and other aerodrome users of the method of working plan;
  - (c) communicating with ATC (if applicable) and aircraft while works are being carried out;
  - (d) carrying out time-limited or emergency works;
  - (e) notifying aircraft operators and other aerodrome users of time-limited or emergency works;
  - (f) carrying out works when the aerodrome is closed to aircraft operations;
  - (g) the use of surface vehicles and equipment, including in accordance with sections 11.14, 14.03 and 14.06, as applicable.



- (2) The aerodrome manual must identify the individuals or positions responsible for the planning, conduct, arrangement and notifications related to aerodrome works.

### **11.08 Wildlife hazard management**

- (1) The wildlife hazard management procedures must be included or referenced in the aerodrome manual to deal with the hazards to aircraft operations caused by the presence of wildlife on or in the vicinity of the aerodrome, including details of the arrangements for the following:
  - (a) monitoring wildlife hazards at the aerodrome;
  - (b) assessing any wildlife hazard;
  - (c) mitigating any wildlife hazard;
  - (d) reporting wildlife hazards to aircraft through one or more of the following as applicable: the AIP, NOTAM, air traffic control, UNICOM;
  - (e) for proposed or actual sources of wildlife attraction outside the aerodrome boundary — liaising with the relevant planning authorities or proponents to facilitate wildlife hazard mitigation.
- (2) The aerodrome manual must identify the individuals or positions responsible for monitoring and mitigating wildlife hazards to aircraft operating at the aerodrome.

### **11.09 Aerodrome safety management**

- (1) If required by Chapter 25 of this MOS, the aerodrome manual must contain details of the aerodrome safety management system.
- (2) If required by Chapter 26 of this MOS, the aerodrome manual must contain details of the risk management plan.

### **11.10 Aerodrome technical inspections**

- (1) If aerodrome technical inspections are required under this MOS, the aerodrome manual must contain procedures for carrying out the inspections, including for the following:
  - (a) identifying the items that must be inspected, and when the inspections are to be carried out;
  - (b) ensuring that technically-qualified people carry out the inspections;
  - (c) scheduling the inspection program and recording the results of the inspections;
  - (d) briefing the technical inspectors on:
    - (i) the required scope of the inspection; and
    - (ii) any particular technical matters or locations which must be inspected;
  - (e) preparing and implementing the corrective action plan to ensure that defects identified in an inspection are corrected as soon as possible;
  - (f) supplying CASA with copies of inspection reports.

*Note* The requirements of a technical inspection are specified in Chapter 12 of this MOS.

- (2) The aerodrome manual must identify the individuals or positions responsible for the following:
  - (a) managing the inspection program;
  - (b) planning the aerodrome technical inspections;
  - (c) reporting the results of the inspections, including reporting on follow-up action;
  - (d) receiving and considering the reports of the inspections;
  - (e) taking follow-up action if defects or deficiencies are identified during an inspection.

### 11.11 Unauthorised entry to aerodrome

The aerodrome manual must contain the procedures for preventing the unauthorised entry onto the movement area (*airside*) of persons, vehicles, equipment, mobile plant or animals (including land-based wildlife) or other things that may endanger aircraft safety, including procedures for the following:

- (a) controlling airside access;
- (b) monitoring airside access control points and barriers, such as fencing.

### 11.12 Aerodrome emergency response

*Note 1* The aerodrome operator is responsible for documenting the aerodrome's emergency management process and should align it with the applicable emergency management legislation of the relevant State or Territory.

*Note 2* For the aerodrome emergency plan, see Chapter 24.

- (1) The aerodrome emergency procedures must be included or referenced in the aerodrome manual and must include:
  - (a) the following:
    - (i) the positions of those who constitute the membership of the aerodrome emergency committee (if established);
    - (ii) a description of the role of each emergency service organisation involved in the emergency response arrangements or aerodrome emergency plan, as applicable;  
*Note* To determine applicability, see sections 24.02 and 24.03.
    - (iii) the procedures for liaison with the authorised person responsible for local emergency planning arrangements;
    - (iv) the procedures for notification and initiation of an emergency response;
    - (v) the procedures for activation, control and coordination of aerodrome-based emergency responders (if any) during the initial stages of an emergency;
    - (vi) the procedures for use of the aerodrome's emergency facilities (if any);
    - (vii) the procedures for facilitating aerodrome access and the management of assembly areas (if any);
    - (viii) the procedures for the aerodrome to respond to a "local stand-by" event, if applicable;
    - (ix) the procedures for initial response to a "full emergency" event on, or in the immediate vicinity of, the aerodrome; and

- (b) the arrangements for keeping aerodrome emergency facilities, access points and assembly areas (if any) in a state of readiness; and
- (c) arrangements to ensure emergency preparedness by both on and off-aerodrome responders through the following:
  - (i) site inductions, if provided;
  - (ii) emergency response training, if provided;
  - (iii) emergency exercises, if required; and
- (d) the arrangements to return the aerodrome to operational status after an emergency; and
- (e) the arrangements for periodic review of the aerodrome emergency plan, if applicable, or for monitoring the function of the aerodrome in local emergency planning arrangements.

*Note* To determine applicability, see sections 24.02 and 24.03.

- (2) The aerodrome manual must identify the individuals or positions responsible for the following:
  - (a) maintaining the aerodrome emergency response procedures, including emergency preparedness;
  - (b) notifying procedures to initiate an emergency response;
  - (c) initiating emergency response actions by aerodrome personnel;
  - (d) returning the aerodrome to operational status after an emergency;
  - (e) reviewing the aerodrome emergency plan, if applicable, or monitoring the function of the aerodrome in local emergency planning arrangements.

*Note* To determine applicability, see sections 24.02 and 24.03.

### **11.13 Disabled aircraft removal**

The aerodrome manual must contain the procedures for removing an aircraft that is disabled on or near the movement area of the aerodrome, including procedures for the following:

- (a) identifying the roles of the aerodrome operator and the holder of the aircraft's certificate of registration;
- (b) notifying the holder of the certificate of registration;
- (c) liaising with the Australian Transport Safety Bureau, the Defence Aviation Safety Authority, and ATC if applicable;
- (d) obtaining appropriate equipment and persons to remove the aircraft;
- (e) identifying:
  - (i) the names and roles of the persons responsible for arranging the removal of an aircraft; and
  - (ii) the telephone numbers for contacting the relevant individuals during and after normal working hours.

### 11.14 Airside vehicle control

If surface vehicles operate on or near the movement area of an aerodrome, the aerodrome manual must contain the procedures for such operations, including procedures:

- (a) for traffic movement (including speed limits) and enforcing traffic rules; and
- (b) for establishing a method of instructing and testing drivers in relation to the traffic rules; and
- (c) requiring the driver of the surface vehicle to read back to ATC the safety-related parts of any ATC clearances or instructions transmitted to the driver by voice.

*Note* See also section 14.06.

### 11.15 Aircraft parking control

- (1) Aircraft parking control procedures:
  - (a) must be established at an aerodrome with scheduled international air transport operations; and
  - (b) may be established at any aerodrome where apron congestion creates a hazard to aircraft operations.
- (2) If aircraft parking control procedures are established at an aerodrome, the aerodrome manual must contain the procedures, including procedures for the following:
  - (a) liaison between ATC and the individuals or positions responsible for apron management;
  - (b) allocating aircraft parking positions;
  - (c) initiating engine start and ensuring clearances for aircraft push back;
  - (d) identifying and using the aerodrome VDGSs, including any A-VDGSs;
  - (e) the marshalling service;
  - (f) the leader (“van”) service or follow-me service;
  - (g) identifying:
    - (i) the names and roles of the individuals responsible for planning and implementing aircraft parking control; and
    - (ii) the telephone numbers for contacting the relevant individuals during and after normal working hours.
- (3) The aerodrome operator must ensure that the apron safety management procedures are followed by any organisation that conducts apron operational activities.

### 11.16 Protection of communication, navigation, surveillance and meteorological facilities

The aerodrome manual must contain procedures for the protection of communication, navigation, surveillance and meteorological facilities (*relevant facilities*) located on the aerodrome in accordance with Chapter 19 of this MOS, including procedures for the following:

- (a) controlling activities near relevant facilities, including ground maintenance;

- (b) in consultation with the facility provider — suppling and installing hazardous emissions warning signs, including electromagnetic and microwave radiation.

### **11.17 All-weather operations**

- (1) The aerodrome manual must contain procedures for the management of ground activities at an aerodrome where low-visibility operations are conducted, including procedures for the following:
  - (a) measuring visibility along a runway and passing the information to ATC, or, at non-towered aerodromes, to pilots, if required;
  - (b) minimising vehicular traffic within the movement area during periods of low-visibility operations;
  - (c) ensuring vehicles do not compromise CNS facilities during periods of low-visibility operations;
  - (d) manoeuvring area inspections during periods of low-visibility operations;
  - (e) identifying:
    - (i) the names and roles of the individuals responsible for managing low-visibility operations; and
    - (ii) the telephone numbers for contacting the relevant individuals during and after normal working hours.
- (2) The aerodrome manual must indicate the location of any transmissometers located on the aerodrome.

## CHAPTER 12 INSPECTING AND REPORTING AERODROME CONDITION AND COMPLIANCE

### Division 1 Serviceability inspections

#### 12.01 General

- (1) The operator of a certified aerodrome must carry out an aerodrome serviceability inspection if any of the following circumstances arise:
  - (a) there has been a severe wind event, a severe storm, or a period of heavy or prolonged rainfall;

*Note 1* If pooling or ponding of water, or poor drainage, is observed on a runway, remedial maintenance *must* be undertaken as soon as possible: see section 18.03.

*Note 2* Aerodrome personnel are not expected to carry out an aerodrome serviceability inspection if weather *events* create a work, health and safety hazard, for example, if lightning in the area requires the movement area to be vacated.
  - (b) if a hazard to aircraft may be present on the manoeuvring area;
  - (c) when requested in writing by CASA;
  - (d) when requested by ATC (where applicable);
  - (e) when aeroplane operations are scheduled, or notified in advance to the aerodrome operator by the aeroplane operator, or are known to be in progress at the aerodrome, and meteorological conditions may have caused:
    - (i) the RWYCC to change; or
    - (ii) a runway surface contaminant type to be present, or to have changed.

*Note* CASA recommends that an additional aerodrome serviceability inspection should be carried out if a pilot or ARFFS provider reports a hazard.
- (2) Without affecting the requirements under subsection (1), for an aerodrome with scheduled air transport operations:
  - (a) at least 2 aerodrome serviceability inspections must be carried out each week, with at least 48 hours between any 2 inspections; and
  - (b) at least 1 aerodrome serviceability inspection must be carried out on each day that an air transport movement is scheduled; and
  - (c) at least 2 aerodrome serviceability inspections must be carried out on each day that an international air transport movement is scheduled for a Code 3 or a Code 4 runway if at least 6 hours elapse between each air transport movement.
- (2A) An aerodrome serviceability inspection carried out to satisfy a requirement of a particular paragraph of subsection (2) may be used to satisfy a requirement of another paragraph of subsection (2).
- (3) Without affecting the requirements under subsection (1), for an aerodrome with no scheduled air transport operations, there must be at least 2 aerodrome serviceability inspections carried out each week, with at least 48 hours between any 2 inspections.

- (4) The operator of an aerodrome must ensure that a serviceability inspection is conducted, or at least supervised, by personnel who are suitably trained to meet all of the training requirements mentioned in section 13.03.

## 12.02 Timing of inspections

- (1) The aerodrome serviceability inspection must be conducted before the first movement (*first movement*) for a scheduled passenger air transport operation occurs.
- (2) If the first movement occurs before first light:
  - (a) the safety critical elements of the serviceability inspection must be carried out before the first movement occurs; and
  - (b) the remainder of the inspection:
    - (i) must be carried out as soon as sufficient daylight is available; and
    - (ii) may be carried out after the first movement occurs.

*Note* The safety critical elements include, for example, FOD, visual aids, significant hazards.

- (3) If a serviceability inspection is required under paragraph 12.01 (1) (a) or (b), it must be carried out as soon as possible.

## 12.03 Serviceability inspection requirements

### Foreign objects

- (1) Any significant object found in the course of a serviceability inspection must be reported immediately to ATC, where applicable.
- (2) **Significant object** means any object that could reasonably be expected to have an adverse effect on the safety of an aircraft.

*Note 1* Significant objects would include, for example, any aircraft parts which may have fallen from an aircraft, or the remains of wildlife which may have been struck by an aircraft.

*Note 2* Reports to the Australian Transport Safety Bureau may also be required in accordance with the *Transport Safety Investigation Regulations 2003*.

### Surface conditions of a movement area

*Note 1* For additional inspection requirements, see also section 12.04A, Global reporting format and aerodrome serviceability inspection requirements.

*Note 2* If pooling or ponding of water is observed on a runway, remedial maintenance must be undertaken as soon as possible: see section 18.03.

- (3) The serviceability inspection must check for the presence of any of the following on the movement area:
  - (a) surface irregularities, including cracking or spalling;
  - (b) pavement deflections, including rutting or slipping;
  - (c) water pooling or ponding;
  - (d) build-up of rubber or other contaminants which may reduce surface friction;
  - (e) surface damage caused by the spillage of corrosive fluids;

- (f) subsurface leaks or pressure, including broken water mains or inadequate or defective drainage;
- (g) scour or erosion ditches;
- (h) termite mounds, sink holes or other ground obstacles obscured by grass;
- (i) soft ground, particularly in combination with surface roughness and slipperiness;
- (j) any other signs of pavement distress which have the potential to rapidly develop into a hazard for aircraft.

*Note 1* Any signs of pavement distress or surface irregularities may require maintenance or verification that adequate surface friction and/or texture is present. See also Chapter 18 of this MOS.

*Note 2* The movement area also includes any corresponding strips for runways and taxiways

### Aerodrome markings, lightings, wind direction indicators and ground signals

- (4) The serviceability inspection must check for the following on, or for use on, the movement area:
  - (a) loss of visibility of markers and markings;
  - (b) incorrect markers or markings;
  - (c) any disturbance to the correct intensity level and alignment of lights;
  - (d) discoloured or dirty lenses;
  - (e) unserviceable lights, incorrectly fitted lights, or lights that are misaligned;
  - (f) stand-by power equipment, to ensure that it is serviceable including the availability of fuel (if applicable);
  - (g) the condition of light bases, MAGS and navigation equipment within the movement area, including strips;
  - (h) exposed edges around footings and other aerodrome installations;
  - (i) damage to the wind indicator assembly or mounting;
  - (j) for wind indicators — damage to sleeve fabric or loss of conspicuous colour;
  - (k) the correct operation of the pilot activated lighting, if installed;
  - (l) the correct operation of the broadcast aerodrome weather station, if installed.

### Cleanliness of the movement area

- (5) The serviceability inspection must check for the following on the movement area:
  - (a) foreign objects, for example, aircraft fastening devices and other aircraft parts;
  - (b) work tools, small items of equipment and personal items;
  - (c) debris, for example, sand, loose rocks, concrete, wood, plastic, pieces of tyre, mud and any other foreign bodies;
  - (d) hazards created during and after construction activity, including hazards arising from vehicles and plant travelling over unpaved, wet or contaminated areas.



### Obstacles infringing the take-off, approach, transitional and PANS-OPS surfaces

- (6) The serviceability inspection must check for any infringements of, or obstructions present in, any of the following surfaces that are visible from the aerodrome:
  - (a) the take-off, approach and transitional elements of the OLS;
  - (b) PANS-OPS airspace, including any critical obstacles that would otherwise affect the safety or integrity of PANS-OPS airspace.

### Wildlife on, or in the vicinity of, the movement area

- (7) The serviceability inspection must include the following:
  - (a) the condition of aerodrome fencing and the security of access points to the movement area;
  - (b) monitoring the presence and behaviour of any wildlife on, or likely to be on, the aerodrome, and identifying seasonal and environmental conditions which may act as an attractant;
  - (c) monitoring evidence of wildlife shelter provided by aerodrome infrastructure, for example, buildings, equipment and gable markers;
  - (d) checking for off-aerodrome wildlife attraction sources, observable from the aerodrome site, for example, mowing activities, seeding, standing water bodies, uncovered waste disposal, deceased wildlife or offal;
  - (e) the presence and operating condition of any wildlife hazard mitigating equipment incorporated into the wildlife hazard management procedures for the aerodrome.

### Empirical assessment of the bearing strength of unrated runway pavements and runway strips

- (8) The serviceability inspection must include empirical assessment of the bearing strength of a runway or a runway strip only if:
  - (a) an unsealed runway is unrated; or
  - (b) any part of the runway strip is available for aircraft operations.

*Note* Although discretion, judgement and local knowledge always form part of empirical assessment of bearing capacity, CASA recommends that appropriate test procedures should be in place for the practical guidance of persons making the assessment.

### Aerodrome fencing and signage

- (9) The serviceability inspection must check for damaged fences, unsecured gates, and signs of attempted entry onto the manoeuvring area by either land-based wildlife or unauthorised persons.

### Aerodrome frequency response unit

- (10) The serviceability inspection must check that an aerodrome frequency response unit (if any) is functioning correctly.

## Currency of NOTAMs

- (11) The serviceability inspection must check on the accuracy and currency of all active NOTAMs requested by the aerodrome.

## Inspection records

- (12) The aerodrome operator must maintain, for at least 2 years after their creation, aerodrome serviceability inspection records that include:
  - (a) the date and time of completion of each serviceability inspection; and
  - (b) the results of each inspection; and
  - (c) a description of any action taken.

### 12.04 Reporting reportable occurrences

*Note* For additional matters to report in relation to aerodrome runway conditions, see also section 12.04A, Global reporting format and aerodrome serviceability inspection requirements, for additional matters to report in relation to aerodrome runway conditions.

- (1) Aerodrome operators must report the following reportable occurrences to the NOTAM Office:
  - (a) any change (whether temporary or permanent) in the published runway information, including changes to information contained in current permanent NOTAMs or in the AIP made in accordance with Part 175 of CASR;
  - (b) aerodrome works affecting the manoeuvring area or the obstacle limitation surfaces, including time-limited works that require more than 10 minutes to restore normal safety standards;
  - (c) outage or unavailability of aerodrome lighting or obstacle lighting, unless the outage or unavailability is fixed immediately;
  - (d) temporary obstacles to aircraft operations, unless the temporary obstacle is removed immediately;
  - (e) any significant increase in, or concentration of, wildlife hazards on or near the aerodrome which constitute a danger to aircraft, unless the wildlife causing the hazard is dispersed immediately;
  - (f) any change within the take-off climb area mentioned in subsection 5.12 (8) that is due to a new or changed obstacle which results in a change to the gradient of more than 0.05% from the published gradient data for the runway — unless that new or changed obstacle is dealt with immediately;
  - (g) the emergence of new obstacles, unless the new obstacle is removed immediately;
  - (h) that a radio navigation aid or landing aid owned by the aerodrome operator is unavailability or has returned to service;
  - (i) any other event which affects the safety of aircraft using the aerodrome, unless the event is ceased immediately.
- (2) A reportable occurrence must be reported:
  - (a) as soon as possible after it is observed; and

- (b) with as much detail as is available; and
  - (c) if necessary to enable further NOTAMs to be issued — supplemented with subsequent additional detail as it becomes available.
- (3) If applicable, ATC must be advised of any unserviceability identified by a serviceability inspection which requires the issue of a NOTAM.
  - (4) An aerodrome operator must provide as much notice as possible through a NOTAM of any aerodrome works that affect airline schedules.

#### 12.04A Global reporting format and aerodrome serviceability inspection requirements

- (1) Without affecting any other requirements under Chapter 12, the aerodrome operator of a certified aerodrome with an operational sealed runway (an *operational runway*) must comply with each requirement mentioned in this section for the runway.
- (2) An aerodrome serviceability inspection carried out for Chapter 12 must specifically check for visible dampness, standing water, snow, slush, ice or frost on an operational runway.

*Note* In this section, snow, slush, ice and frost of various kinds are described as “other contaminants”, to distinguish them from contamination by dampness or water.

#### Using runway surface description to determine the RWYCC

- (3) The aerodrome operator must use the applicable runway surface description mentioned in Table 12.04A (3) to determine the applicable RWYCC for an operational runway.

**Table 12.04A (3) — RWYCC**

<b>Using a runway surface description to assign a RWYCC</b>	
<b>For a runway surface description of:</b> Column 1	<b>the applicable RWYCC is:</b> Column 2
DRY	<b>6</b>
WET (The runway surface is covered by any visible dampness or water up to and including 3 mm depth)	<b>5</b>
WET (“slippery wet” runway)	<b>3</b>
STANDING WATER	<b>2</b>

*Note* For guidance on the RWYCC assignment, see PANS-Aerodromes which includes WET and DRY conditions.

#### Wet or standing water (but not slippery wet) — reporting

- (4) When aeroplane operations are scheduled, or notified in advance to the aerodrome operator by the aeroplane operator, or are known to be in progress at the aerodrome, the aerodrome operator must report an operational runway that is wet, or has standing water, as soon as possible in an RCR.
- (5) The RCR must include:
  - (a) the relevant runway number; and

- (b) subject to paragraph (c), for each identified one-third length of the runway, the applicable RWYCC and runway surface description in accordance with Table 12.04A (5); and
- (c) if 25% or less, of a one-third length of the runway has standing water on it — a RWYCC of 5 (WET) for the one-third length; and
- (d) if the depth of any standing water on the runway is reasonably ascertainable — a report of the depth of that standing water.

**Table 12.04A (5) — Wet or standing water reports**

<b>For a runway surface description of:</b> Column 1	<b>the applicable RWYCC is:</b> Column 2	<b>and the report must be made to:</b> Column 3
WET	<b>5</b>	ATC (if available)
STANDING WATER	<b>2</b>	(a) the NOTAM Office, and ATC (if available); and (b) if the ATC is not available — pilots, but only where the aerodrome operator has available UNICOM or CA/GRS.

*Note* UNICOM or CA/GRS services can be used to report an RCR if they are operating at the time of the runway surface condition.

- (6) The RCR must be made to the relevant persons in accordance with Table 12.04A (5).
- (7) Despite subsection (4), if an agreement exists between the aerodrome operator and ATC for ATC to assess and report the runway or a portion of it when WET or DRY, the aerodrome operator does not need to make the RCR to ATC.

**Slippery wet — reporting**

- (8) When aeroplane operations are scheduled, or notified in advance to the aerodrome operator by the aeroplane operator, or are known to be in progress at the aerodrome, the aerodrome operator must report an operational runway, as soon as possible in an RCR, if:
  - (a) it is slippery wet; or
  - (b) the aerodrome operator has received at least 2 consecutive pilot reports of MEDIUM runway braking action for the runway, or a portion of it; or
  - (c) the aerodrome operator has received at least 2 consecutive ATC reports of MEDIUM runway braking action for the runway, or a portion of it.

*Note* Pilot reports of runway braking action as MEDIUM, meaning a slippery wet runway surface, are based on pilot observations that braking deceleration is noticeably reduced for the wheel braking effort applied, or that directional control is noticeably reduced.

- (9) The RCR must include:
  - (a) the relevant runway number; and

- (b) for each identified one-third length of the runway:
  - (i) the applicable RWYCC and runway surface description in accordance with Table 12.04A (9); and
  - (ii) the applicable percentage extent of the slippery wet surface.
- (10) The RCR must be made to the relevant persons in accordance with Table 12.04A (9).

**Table 12.04A (9) — Slippery wet reports**

<b>For a runway surface description of:</b> Column 1	<b>the applicable RWYCC is:</b> Column 2	<b>and the report must be made to:</b> Column 3
SLIPPERY WET	<b>3</b>	(a) the NOTAM Office, and ATC (if available); and  (b) if the ATC is not available — pilots, but only where the aerodrome operator has available UNICOM or CA/GRS.

Other contaminants — using runway surface description to determine the RWYCC

- (11) For other contaminants, the aerodrome operator must use the runway surface description mentioned in Table 12.04A (11) to determine the applicable RWYCC for an operational runway.

**Table 12.04A (11) – Other contaminants – RWYCC**

<b>Using a runway surface description to assign a RWYCC for other contaminants</b>	
<b>For a runway surface description of:</b> Column 1	<b>the applicable RWYCC is:</b> Column 2
FROST SLUSH (up to and including 3 mm depth) DRY SNOW (up to and including 3 mm depth) WET SNOW (up to and including 3 mm depth)	<b>5</b>
COMPACTED SNOW (Outside air temperature minus 15 degrees Celsius and below)	<b>4</b>
DRY SNOW (more than 3 mm depth) WET SNOW (more than 3 mm depth) DRY SNOW ON TOP OF COMPACTED SNOW (any depth)	<b>3</b>

<b>Using a runway surface description to assign a RWYCC for other contaminants</b>	
<b>For a runway surface description of:</b>	<b>the applicable RWYCC is:</b>
Column 1	Column 2
WET SNOW ON TOP OF COMPACTED SNOW (any depth) COMPACTED SNOW (outside air temperature above minus 15 degrees Celsius)	
SLUSH (more than 3 mm deep)	<b>2</b>
ICE	<b>1</b>
WET ICE WATER ON TOP OF COMPACTED SNOW DRY SNOW OR WET SNOW ON TOP OF ICE	<b>0</b>

*Note* This RWYCC assignment table is in PANS-Aerodromes and includes SNOW and ICE conditions.

#### Other contaminants — reporting

- (12) When aeroplane operations are scheduled, or notified in advance to the aerodrome operator by the aeroplane operator, or are known to be in progress at the aerodrome, the aerodrome operator must report an operational runway that has other contaminants, as soon as possible in an RCR.
- (13) The RCR must include:
- (a) the relevant runway number; and
  - (b) subject to paragraph (c), for each identified one-third length of the runway, the applicable RWYCC and runway surface description in accordance with Table 12.04A (11); and
  - (c) if 25% or less, of a one-third length of the runway has other contaminants on it — a RWYCC of 5 (WET) for the one-third length; and
  - (d) if the depth of any other contaminants on the runway is reasonably ascertainable — a report of the depth of the contaminants.
- (14) The RCR must be made to:
- (a) the NOTAM Office and ATC (if available); and
  - (b) if the ATC is not available — pilots, but only where the aerodrome operator has available UNICOM or CA/GRS.

## CHAPTER 12

### Division 2 Aerodrome technical inspection programs

#### 12.05 Content of aerodrome technical inspection programs

- (1) Section 12.09 sets out the elements which comprise an aerodrome technical inspection.
- (2) Subject to sections 12.06 and 12.07, an aerodrome technical inspection must comply with section 12.09.

#### 12.06 Inspections at higher volume movement aerodromes

- (1) For an aerodrome that, in the course of a financial year, has:
  - (a) 50 000 or more air transport passenger movements; or
  - (b) 100 000 or more aircraft movements;a technical inspection program must be established and implemented for the aerodrome.
- (2) For subsection (1), all elements of the first aerodrome technical inspection must be implemented not later than 12 months after:
  - (a) for paragraph (1) (a) — the date of publication, by the Department, of the air transport passenger movement numbers indicating that, for the first time under this MOS, there have been 50 000 or more air transport passenger movements for the aerodrome for the financial year; or
  - (b) for paragraph (1) (b) — the date the aerodrome operator becomes aware of information indicating that, for the first time under this MOS, there have been 100 000 or more aircraft movements at the aerodrome in the course of the financial year.
- (3) Each element of the second and subsequent technical inspections must be implemented not later than 12 months after the element was last implemented in a technical inspection.
- (4) If paragraph (2) (a) or (2) (b):
  - (a) applied to an aerodrome operator (including by operation of this subsection); and
  - (b) subsequently ceased to apply to the operator; and
  - (c) subsequently applied again to the operator;then:
  - (d) the subsequent application of the paragraph is to be treated as if it were the first time it applied (the *deemed first time*); and
  - (e) subsections (3) and (4) apply to the operator for the second and subsequent technical inspections after the deemed first time.
- (5) In this section, *element* has the meaning given in subsection 12.09 (8).

#### 12.07 Inspections at lower volume movement aerodromes

- (1) Subject to subsection (2), for an aerodrome that, in the course of a financial year, has:
  - (a) at least 10 000 but less than 50 000 air transport passenger movements; or

- (b) at least 20 000 but less than 100 000 aircraft movements;  
a technical inspection program must be established and implemented for the aerodrome.
- (2) For subsection (1), all elements of the first aerodrome technical inspection must be implemented not later than 12 months after:
  - (a) for paragraph (1) (a) — the date of publication, by the Department, of the air transport passenger movement numbers indicating that, for the first time under this MOS, there have been at least 10 000 air transport passenger movements for the aerodrome for the financial year; or
  - (b) for paragraph (1) (b) — the date the aerodrome operator becomes aware of information indicating that, for the first time under this MOS, there have been at least 20 000 aircraft movements at the aerodrome in the course of the financial year.
- (3) Each element of the second and subsequent technical inspections (except the elements mentioned in subsections 12.09 (2) and (3)) must be implemented not later than 12 months after the element was last implemented in a technical inspection.
- (4) Each element of a technical inspection mentioned in subsections 12.09 (2) and (3) must be implemented not later than 24 months after the element was last implemented in a technical inspection.
- (5) If paragraph (2) (a) or (2) (b):
  - (a) applied to an aerodrome operator (including by operation of this subsection); and
  - (b) subsequently ceased to apply to the operator; and
  - (c) subsequently applied again to the operator;
 then:
  - (d) the subsequent application of the paragraph is to be treated as if it were the first time it applied (the *deemed first time*); and
  - (e) subsections (3), (4) and (5) apply to the operator for the second and subsequent technical inspections after the deemed first time.
- (6) In this section, *element* has the meaning given in subsection 12.09 (8).

## 12.08 Other requirements for aerodrome technical inspection programs

- (1) Parts of a technical inspection program may be carried out at different times from the other parts provided that all parts of the technical inspection program are completed within the applicable interval for the program (or element of the program) mentioned in section 12.06 or 12.07.
- (2) Despite anything else in this section, if any defect or deficiency in a part of the aerodrome is identified in an aerodrome serviceability inspection, an inspection, under the technical inspection program of that part of an aerodrome, must be carried out immediately of that part.
- (3) Any technical inspection program must check for:
  - (a) non-compliance with standards in this MOS; and
  - (b) any defects or deterioration in the condition of:
    - (i) the movement area; or



- (ii) visual aids and related equipment, including matters specified in section 12.09.
- (4) If any of the following is identified during the implementation of a technical inspection program, it must be recorded in the technical inspection report:
- (a) any non-compliance with this MOS by the aerodrome facility, its equipment, operation, or aerodrome personnel;
  - (b) any defects or deterioration in any facility, equipment or visual aid which could make the aerodrome unsafe for aircraft operations;
  - (c) any incorrect aerodrome information:
    - (i) published in the AIP or NOTAMs; or
    - (ii) reported to ATC (if applicable);
  - (d) any information in the aerodrome manual which is incorrect or not current;
  - (e) any procedure in use at the aerodrome which is not in accordance with, or conflicts with, procedures in the aerodrome manual.
- (5) Following completion of any element of the technical inspection program, the aerodrome operator must prepare one or more plans for corrective action that is needed (***corrective action plans***). A plan must include a time-frame for implementation of the plan.
- (6) If:
- (a) a proposed action is recommended by a technical inspector in the technical inspection report; and
  - (b) the action is not supported by the aerodrome operator;
- then the reasons for not supporting the action must be included in the relevant corrective action plan under subsection (5).
- (7) The aerodrome operator must supply CASA with a copy of the technical inspection report within 30 days of the operator receiving the report, or such longer time as is agreed to by CASA in writing.
- (8) If CASA makes a request in writing, the aerodrome operator must, within 30 days, supply CASA with a copy of the plan for corrective action, including details of any progress already made to address any defects or deterioration identified by the technical inspection.
- (9) The aerodrome operator must:
- (a) both:
    - (i) keep the records of each technical inspection program; and
    - (ii) retain each record for at least 3 years after the technical inspection program to which the record relates was completed; or
  - (b) if the operator has elected to have a part or parts of a technical inspection program conducted at different times under subsection (1):
    - (i) keep the records of each part of each inspection so conducted; and
    - (ii) retain those records for at least 3 years after the last part of the inspection program was completed.

## 12.09 Inspection requirements

- (1) A technical inspection must include the following:
  - (a) an instrument survey of the approach, the take-off and the transitional surfaces;
  - (b) a check of other applicable surfaces associated with the OLS;  
*Note* For the applicable surfaces, see Chapter 7 of this MOS.
  - (c) a check of the aerodrome operator's monitoring of the instrument approach procedure-critical obstacles nominated by the procedure designer for any terminal instrument flight procedures published for the aerodrome.
- (2) The technical inspection must also include an inspection and assessment of the movement area pavements, drainage and associated strips, including a visual inspection and assessment of:
  - (a) pavement condition; and
  - (b) contamination, including from rubber build-up.
- (3) The technical inspection must also include an inspection and testing of the aerodrome lighting and electrical reticulation systems, including the following sub-elements:
  - (a) visual aids on the movement area;
  - (b) apron floodlighting, including illumination of the apron and parking positions;
  - (c) illuminated wind direction indicators;
  - (d) pilot-activated lighting systems (if applicable);
  - (e) stand-by and emergency aerodrome lighting (if applicable);
  - (f) the visual approach slope indicator system (if applicable);
  - (g) approach lighting systems (if applicable);
  - (h) obstacle lights and beacons maintained by the aerodrome operator;
  - (i) any earthing points on the apron (if applicable).
- (4) The technical inspection must also include an inspection and assessment of visual aids on the aerodrome, including the following sub-elements:
  - (a) movement area markings;
  - (b) movement area guidance signs, including aircraft parking position signs;
  - (c) airside vehicle control signs;
  - (d) protection of navigational aids and meteorological equipment signs.
- (5) The technical inspection must include an inspection of equipment or facilities at the aerodrome used for any of the following:
  - (a) wildlife hazard management, including aerodrome fencing and gates;
  - (b) aerodrome emergencies.
- (6) The technical inspection must include the following:
  - (a) a check of the currency and accuracy of:
    - (i) aerodrome information published in the AIP; and

- (ii) aerodrome operating procedures specified in the aerodrome manual and supporting documents;
  - (b) a check that the safety management system or risk management plan (as applicable) is up-to-date and is functioning as documented;
  - (c) an inspection of airside vehicle control arrangements (if applicable).
- (7) The technical inspection must include a check that personnel appointed as a reporting officer or works safety officer:
- (a) have been trained and assessed in accordance with Chapter 13; and
  - (b) appear to be generally competent to carry out the required duties in accordance with this MOS.
- (8) Any survey, check, inspection, assessment or test mentioned in this section that may reasonably be performed and completed as a single and discrete task, is an “element” for the purposes of sections 12.06 and 12.07.

### **12.10 Conduct of aerodrome technical inspections**

- (1) The operator of an aerodrome must ensure that a technical inspection is conducted by a person or persons with relevant technical qualifications and experience, or demonstrable relevant technical experience.
- (2) For subsection (1):
- (a) the movement area, other pavements and drainage must be inspected by a person who has a recognised degree, diploma or certificate in civil engineering, or demonstrable relevant technical experience in civil engineering; and
  - (b) the lighting and electrical facilities must be inspected by a qualified person who is an electrical engineer or a licensed electrician with relevant aerodrome lighting knowledge and experience; and
  - (c) the following apply:
    - (i) for paragraph 12.09 (1) (a) — the obstacle limitation surfaces must be inspected by a person who is technically qualified or experienced in surveying;
    - (ii) for paragraph 12.09 (1) (b) — the other surfaces must be inspected by a person:
      - (A) mentioned in subparagraph (i); or
      - (B) who has a sound knowledge and understanding of the standards for OLS;
    - (iii) for both paragraphs 12.09 (1) (a) and (1) (b) — the person conducting the inspection must have a sound knowledge and understanding of the standards and survey procedures for obstacle limitation surfaces; and
  - (d) the inspection checks of the aerodrome manual, supporting procedures and published aerodrome information in the AIP must be conducted by a person with sound knowledge and experience of the civil aviation safety legislation applicable to the inspection, reporting, operation and maintenance of aerodromes.

*Note* CASA recommends that the technical inspectors are trained in, or are familiar with, auditing techniques.

- (3) Records of qualifications and relevant experience held by a person or persons conducting an aerodrome technical inspection must be:
  - (a) maintained as part of the aerodrome manual; or
  - (b) included in the report for the aerodrome technical inspection.
- (4) For subsections (1) and (2), the demonstrable, relevant technical experience of a person must be:
  - (a) maintained as part of the aerodrome manual; or
  - (b) included in the report for the aerodrome technical inspection.

### 12.11 Annual aerodrome manual validation and report

- (1) For an aerodrome that, in the course of a financial year, has:
  - (a) less than 10 000 air transport passenger movements; or
  - (b) less than 20 000 aircraft movements;an aerodrome manual validation (a **validation**) must be carried out.
- (2) The first validation must be carried out not later than 12 months after:
  - (a) for paragraph (1) (a) — the date of publication, by the Department, of the air transport passenger movement numbers indicating that, for the first time under this MOS, there have been less than 10 000 air transport passenger movements for the aerodrome for the financial year; or
  - (b) for paragraph (1) (b) — the date the aerodrome operator becomes aware of information indicating that, for the first time under this MOS, there have been less than 20 000 aircraft movements at the aerodrome in the course of the financial year.
- (3) The second validation must be carried out not later than 12 months after the first validation, and the validation must be carried out at least once every 12 months thereafter.
- (4) If paragraph (2) (a) or (2) (b):
  - (a) applied to an aerodrome operator; and
  - (b) subsequently ceased to apply to the operator; and
  - (c) subsequently would have applied to the operator again if such application were deemed to be for the first time under this MOS;then:
  - (d) the paragraph applies to the operator as if it were for the first time under this MOS (the **deemed first time**); and
  - (e) subsection (3) applies to the operator for the second and subsequent technical inspection programs after the deemed first time.
- (5) Parts of a validation may be carried out at different times from the other parts provided that all parts of the validation are completed within the interval for the validation provided for by this section.
- (6) Despite anything else in this section, if an aerodrome serviceability inspection identifies a defect or deficiency mentioned in paragraph (8) (a), (b) or (c), a validation must be carried out immediately.

- (7) A validation must check for non-compliance with the standards in this MOS, and for any error in reported information for the items listed in subsection (11).
- (8) If any of the following is identified during a validation, a report must be submitted to CASA within 30 days of the identification:
- (a) incorrect aerodrome information published in the AIP or a NOTAM, or reported to ATC (if applicable);
  - (b) any details in the aerodrome manual which are incorrect or are not current;
  - (c) any procedure in use at the aerodrome which is not in accordance with, or conflicts with, procedures in the aerodrome manual.
- Note* If CASA is sent an amendment to the aerodrome manual which addresses the deficient items outlined in this subsection, this would normally constitute an acceptable report.
- (9) Following completion of a validation, the aerodrome operator must correct any errors and anomalies in the aerodrome manual as soon as possible.
- (10) The aerodrome operator must keep in safe custody records of the results of the annual validation, for at least 3 years after the validation.
- (11) The annual validation must include the following:
- (a) a check of the approach, take-off, and transitional surfaces to ensure published aerodrome information is accurate to within 0.05% of the published gradient in the AIP-ERSA;
  - (b) a check of the other surfaces associated with the OLS;
  - (c) a check of the aerodrome operator's monitoring of the instrument approach procedure critical obstacles nominated by the procedure designer for any terminal instrument flight procedures published for the aerodrome;
  - (d) a check of the currency and accuracy of:
    - (i) aerodrome information published in the AIP; and
    - (ii) aerodrome operating procedures specified in the aerodrome manual and supporting documents;
  - (e) a check that each person appointed as a reporting officer or a works safety officer is trained and generally competent to carry out the required functions in accordance with this MOS.
- (12) For subsection (11):
- (a) the obstacle limitation surfaces must be checked by a person who:
    - (i) is technically qualified or experienced in surveying; or
    - (ii) both:
      - (A) has a sound knowledge and understanding of the standards for obstacle limitation surfaces; and
      - (B) can, by appropriate means, validate the accuracy of the current published information in the AIP; and
  - (b) the check of the aerodrome manual, supporting procedures and published aerodrome information in the AIP must be confirmed by a person with sound knowledge and

experience of the regulations and standards that are applicable to the inspection, reporting, operation and maintenance of aerodromes.

*Note* CASA recommends that persons carrying out validation or confirmation are trained in, or familiar with, auditing techniques.

- (13) Records of qualifications and experience held by a person or persons conducting a validation or confirmation must be either:
- (a) maintained as part of the aerodrome manual; or
  - (b) included in the report for the annual aerodrome manual validation.

## CHAPTER 13 AERODROME PERSONNEL FUNCTIONS

### 13.01 Introduction

The aerodrome operator's aerodrome manual must record the name, position and functions of each person occupying, or performing the duties of, the following positions (however described):

- (a) the accountable manager;
- (b) the reporting officer;
- (c) for routine aerodrome works carried out at the aerodrome — the works safety officer.

*Note* Regarding positions for non-routine works under a method of working plan (MOWP), see subsections 15.01 (9) and 16.07 (2).

### 13.02 Accountable manager

The accountable manager must have a general knowledge of the relevant civil aviation safety legislation and standards that are applicable to the inspection, reporting, operation and maintenance of the aerodrome.

*Note* The functions of the accountable manager are specified in subregulation 139.110 (5) of CASR.

### 13.03 Reporting officer

An aerodrome operator must ensure that the reporting officer is suitably trained so that the officer has the following:

- (a) a sound knowledge of the physical characteristics of the aerodrome movement area, the aerodrome obstacle limitation surfaces, aerodrome markings, visual aids (including lighting) and the correct operation of essential aerodrome safety equipment;
- (b) an understanding of the aerodrome information published in the AIP;
- (c) the ability to carry out an aerodrome serviceability inspection, including in relation to runway surface conditions, in accordance with Chapter 12 of this MOS;
- (d) the ability to carry out the reporting functions for the aerodrome, including in relation to runway surface conditions, in accordance with Chapter 12 of this MOS and Part 175 of CASR;
- (e) the ability to carry out the wildlife monitoring and management functions for the aerodrome in accordance with Chapter 17 of this MOS;
- (f) a knowledge of the aerodrome procedures in the aerodrome manual, including in relation to the following:
  - (i) aerodrome works safety;
  - (ii) aerodrome emergency planning and response;
  - (iii) airside vehicle control (if applicable);
  - (iv) aircraft parking control (if applicable);
  - (v) low-visibility operations (if applicable).

*Note* These training requirements also apply to a person who conducts an aerodrome serviceability inspection — see subsection 12.01 (4).

### 13.04 Works safety officer

Aerodrome operators must ensure that each works safety officer has been suitably trained and is able to undertake the following functions:

- (a) ensure the safety of aircraft operations in accordance with:
  - (i) the standards for aerodrome works; and
  - (ii) the procedures in the aerodrome manual; and
  - (iii) the procedures in the applicable MOWP (the **MOWP**);
- (b) ensure that, if applicable, aerodrome works are notified by the issue of a NOTAM whose text reflects the MOWP;
- (c) ensure that ATC (if applicable) is provided with whatever information is necessary for the safety of aircraft operations;
- (d) ensure that the works party or organisation is briefed, on a daily basis, on any matters necessary for the safety of aircraft operations;
- (e) ensure that unserviceable portions of the movement area, temporary obstructions, and the limits of the works area are correctly marked and lit in accordance with the standards in this MOS and the MOWP;
- (f) ensure that vehicles, plant and equipment carrying out aerodrome works are:
  - (i) properly marked and lit; or
  - (ii) under works safety officer supervision; or
  - (iii) within a properly marked and lit works area;
- (g) ensure that all other requirements of the directions within the MOWP are complied with relating to vehicles, plant, equipment and materials;
- (h) ensure that access to work areas is restricted to clearly identified access routes in accordance with the MOWP;
- (i) ensure that excavation is carried out in accordance with the MOWP and, in particular, so as to avoid damage or loss of calibration to any underground power or control cable associated with a lighting system or any navigational aid;
- (j) ensure reports are immediately made to the aerodrome reporting officer of any incident, or damage to facilities, likely to affect:
  - (i) ATC services; or
  - (ii) the safety of aircraft; or
  - (iii) published information in the AIP;
- (k) ensure works are continually supervised while in progress, and that the aerodrome is open to aircraft operations;
- (l) ensure that works vehicles, plant and personnel are evacuated from the movement area when necessary for the safety of aircraft operations;
- (m) ensure that the movement area is returned to a safe condition for aircraft operations following removal of vehicles, plant, equipment and personnel from the works area;



- (n) in the case of time-limited works — ensure that all reasonable measures are taken to return the works area to normal safety standards not less than 5 minutes before the time scheduled or notified for an aircraft movement;
- (o) ensure that floodlighting, and any other lighting required for carrying out aerodrome works, is managed so as not to represent a hazard to aircraft operations.

## CHAPTER 14 CONTROL OF AIRSIDE ACCESS AND VEHICLE CONTROL

*Note* Aerodrome operators may provide a dedicated airside licence, permit or authorisation to manage significant hazards associated with airside vehicle control.

### 14.01 Airside access and operation of vehicles — training

- (1) A driver (*airside driver*) operating a vehicle on the airside (an *airside vehicle*) must be trained to know and understand the following:
  - (a) the terminology used to describe the movement area;
  - (b) the purpose and location of all airside areas;
  - (c) hazardous or prohibited areas on the airside;
  - (d) the significance of aerodrome visual aids and signs.
- (2) Despite subsection (1), for an aerodrome with no scheduled air transport operations, an induction may take the place of formal training, provided that the matters mentioned in paragraphs (1) (a) to (d) are covered in the induction.
- (3) An aerodrome operator must ensure that no vehicle is driven or operated airside unless the vehicle is an airside vehicle driven or operated by an airside driver in accordance with this Chapter.
- (4) Subsection (1) does not apply if an airside driver in an airside vehicle is under direct escort by another airside driver in another airside vehicle who is:
  - (a) operating in accordance with subsection (1); and
  - (b) authorised by the aerodrome operator to provide the escort service.
- (5) For subsection (4), the aerodrome operator must have procedures in the aerodrome manual to ensure that any escort service provider who is not the aerodrome operator is monitored for compliance with this Chapter.

### 14.02 Airside access permits

For an aerodrome that, in the course of a financial year, has more than 350 000 air transport passenger movements or more than 100 000 aircraft movements, the aerodrome operator must comply with the following not later than 6 months after the date of publication, by the Department, of the movement numbers for the aerodrome for the financial year:

- (a) establish a permit system for the airside operation of airside vehicles;
- (b) verify the competency of all airside drivers;
- (c) actively monitor all airside drivers for the possession of a licence and compliance with the established airside driving rules.

### 14.03 Airside vehicle requirements

- (1) The aerodrome operator must have procedures in the aerodrome manual to ensure that airside vehicles, including ground equipment operated airside, are maintained so as to prevent:
  - (a) any avoidable breakdown or unsafe operation; and

(b) any spillage of fuel, lubricant or hydraulic fluid.

*Note* Airside vehicles and equipment may include the vehicles and equipment of third parties with airside access, and consequently the aerodrome manual must have procedures addressing prevention of breakdowns or spillage by such vehicles and equipment.

- (2) The aerodrome operator must:
- (a) establish speed limits for airside vehicles on the movement area; and
  - (b) have arrangements for the monitoring and enforcement of traffic rules, including speed limits.
- (3) The aerodrome operator must have procedures in the aerodrome manual to ensure that airside vehicles must not be driven:
- (a) under an aircraft; or
  - (b) within 3 m of lateral clearance, or within 1 m of overhead clearance, of any part of an aircraft;
- except when required for servicing the aircraft.
- (4) Subject to subsections (7) and (8), an airside vehicle operating on a runway strip, a runway, a taxiway strip or a taxiway must be equipped for communications as follows:
- (a) for a non-controlled aerodrome or an aerodrome where ATC is not in operation — at least a VHF receiver capable of monitoring the CTAF or ATC frequencies, as applicable.
  - (b) for a controlled aerodrome where ATC is in operation — a VHF radio capable of two-way communications with ATC.
- (5) If using a transmitter, the operator of an airside vehicle operating on a runway strip, a runway, a taxiway strip or a taxiway must:
- (a) be certified under Part 64 of CASR for the use of radiocommunication equipment; and
  - (b) monitor the relevant frequency at all times when operating on the manoeuvring area.
- (6) An airside vehicle must remain clear of a runway strip, a runway, a taxiway strip or a taxiway when it is in use, or intended to be used, by an aircraft, unless there is a safety-related or operational requirement for the vehicle to operate in these areas.
- (7) Subsection (4) does not apply to vehicles operating on a designated live taxiway crossing marked across a taxiway on the manoeuvring area, if:
- (a) at a controlled aerodrome — the location of the live taxiway crossing has been agreed to in writing by the ATS provider; and
  - (b) the crossing is marked in accordance with section 8.54 (Vehicle service road markings); and
  - (c) all drivers using the crossing are appropriately licenced, and trained and assessed specifically in relation to the dangers of using the live taxiway crossing; and
  - (d) compliance by crossing vehicles is monitored by the aerodrome operator against the relevant vehicle procedures; and
  - (e) crossing does not occur when low-visibility procedures are in effect.

*Note 1* Designation of a relevant live taxiway crossing is by the aerodrome operator, in consultation with the ATS provider.

*Note 2* See section 23.03 (Implementation of low-visibility procedures).

- (8) Subsection (4) does not apply to an airside vehicle or equipment if the vehicle or equipment is under escort by another vehicle that is equipped in accordance with subsection (4).

#### 14.04 Surveillance equipment installed on an airside vehicle

For compliance with paragraph 139.130 (2) (a) of CASR:

- (a) the surveillance equipment installed on a vehicle must:
  - (i) be a non-transponder device emitting 1090 MHz extended squitter using Downlink Format 18 (DF=18); and
  - (ii) be compatible with the aerodrome ground surveillance system; and
- (b) the surface movement guidance and control system in use at the aerodrome must:
  - (i) comply with the requirements for B2 Low class transmitters in accordance with ICAO Annex 10, Volume IV, Chapter 5, as in force or existing from time to time; and
  - (ii) transmit power of at least 8.5 dBW but less than 18.5 dBW.

#### 14.05 Airside vehicle lighting requirements

- (1) An airside vehicle must be lit if moving or operating:
  - (a) on the movement area at night; or
  - (b) during periods of low visibility.
- (2) Subject to subsection (3), an airside vehicle moving or operating on a runway strip, a runway, a taxiway strip or a taxiway must be lit even during the hours of daylight.
- (3) A vehicle directly connected to an aircraft, including a glider, is not required to have a light mentioned in subsection (4) during the hours of daylight provided the standard manufacturer-fitted vehicle hazard warning lights that conform to the Australian Design Rules, as in force or existing from time to time, are in operation.

*Note* A glider under tow by a vehicle is considered to be a taxiing aircraft and no dedicated light on top of the vehicle is required.

- (4) Subject to subsections (5), (6) and (7), a light must be placed on top of an airside vehicle.
- (5) If a light cannot be placed on top of an airside vehicle, additional lights must be provided in other locations on the vehicle to ensure visibility in all directions.
- (6) For an aerodrome not servicing scheduled air transport operations, an airside vehicle operating during the hours of daylight in accordance with subsection (2) may use standard manufacturer-fitted vehicle hazard warning lights that conform to the Australian Design Rules, as in force or existing from time to time.

*Note* The Australian Design Rules are freely available at: <http://infrastructure.gov.au/roads/motor/design>.

- (7) At an international aerodrome or an aerodrome with scheduled air transport operations, an airside vehicle operating in accordance with subsection (2) must be fitted with a dedicated rotating or flashing vehicle hazard light (a **rotating or flashing light**).
- (8) For subsection (7), the rotating or flashing light must:
  - (a) be yellow or amber in colour; and

- (b) flash at a rate of 60-90 flashes per minute; and
  - (c) where possible, have a peak intensity of between 40 cd and 400 cd; and
    - Note* CASA recommends that vehicle hazard lights should be visible at a distance of at least 200 m in daylight conditions.
  - (d) be placed on top of the vehicle and visible from all directions, unless this is impossible in which case additional, equivalent rotating or flashing lights must be provided in other locations to ensure visibility in all directions.
- (9) For subsection (7), the rotating or flashing light must operate whether the vehicle is moving or stationary, on a runway strip, a runway, a taxiway strip or a taxiway.
  - (10) Aircraft servicing equipment that does not have its own motive power and is used only on aprons is not an airside vehicle and is not required to comply with subsection (1) or (2).
  - (11) An airside vehicle or equipment is not required to comply with the lighting requirements of this section if it is under escort by another vehicle which does comply with the requirements of this section.

#### **14.06 Surface vehicle control and communications**

- (1) Subject to subsection (2), the driver of a vehicle must not operate on the manoeuvring area of a controlled aerodrome without authorisation from the ATC service.
- (2) Subsection (1) does not apply if the ATC service is not in operation for the aerodrome.
  - Note* Authorisation may be in the form of an ATC clearance or in accordance with an agreement in writing between the aerodrome operator and the ATS provider.
- (3) The driver of a vehicle operating, or intending to operate, on the manoeuvring area of a controlled aerodrome must:
  - (a) comply with any clearances and instructions issued by an air traffic controller; and
  - (b) read back to the air traffic controller the safety-related parts of any clearance or instruction which the controller has transmitted by voice.
- (4) Without affecting subsection (3), the following parts of a clearance or instruction must always be read back to the air traffic controller:
  - (a) any route specified in a clearance or instruction;
  - (b) any clearance to, any conditional clearance to, or any instruction to, operate on, enter, stop on, wait on, hold short of, cross, or vacate, any runway or taxiway;
  - (c) any radio frequency instructions.

## CHAPTER 15 AERODROME WORKS

### 15.01 General

- (1) The operator of a certified aerodrome must make all necessary arrangements to ensure that aerodrome works do not create a hazard to aircraft or cause confusion to pilots.

*Note* Aerodrome works may be carried out without the closure of the aerodrome, provided safety precautions are adhered to.

- (2) An aerodrome operator must not carry out aerodrome works without a method of working plan (**MOWP**) for those works unless:
  - (a) the works are time-limited works; or
  - (b) subject to subsection (3), the aerodrome is closed during the works; or
  - (c) subject to subsection (4), the works are of an emergency nature; or
  - (d) the works do not require any restrictions to aircraft operations.
- (3) For paragraph (2) (b), an MOWP is not required if the aerodrome operator temporarily closes the aerodrome, provided that each of the following is given written notice of the intention to temporarily close the aerodrome at least 14 days before the closure:
  - (a) air transport operators using the aerodrome;
  - (b) each other known organisation using the aerodrome which is likely to be affected by the closure;
  - (c) CASA.
- (4) For paragraph (2) (c), works are of an emergency nature if they are:
  - (a) to repair unforeseen damage to part of the manoeuvring area; or
  - (b) to remove an obstacle.
- (5) Subsection (2) does not apply if:
  - (a) the aerodrome is not used for:
    - (i) scheduled air transport operations; or
    - (ii) emergency services aircraft based at the aerodrome (**fixed-base emergency services aircraft**); and

*Note* Despite subsection (5), CASA recommends that aerodrome operators intending to carry out aerodrome works without a MOWP should consult with operators of relevant air ambulance aircraft, any operators based on the aerodrome and other key stakeholders, in relation to the aerodrome works.

- (b) the aerodrome operator complies with subsection (1).

*Note* The temporary closure of the aerodrome during the works period may be one such method provided no essential operations or emergency services aircraft are required to use the aerodrome.

- (6) For works where an MOWP is issued, a NOTAM giving the time and date of the planned commencement of the works, or a planned change in works stage, must be requested as early as possible but not less than 48 hours before commencement of the works or works stage.

- (7) Subsection (6) does not apply for unforeseen events affecting planned works if as soon as possible after the change becomes known:
  - (a) a NOTAM is requested; and
  - (b) either:
    - (i) notification on AFRU is provided (if applicable); or
    - (ii) notification on the automatic terminal information service (*ATIS*) is requested (if applicable).
- (8) For works that are not of an emergency nature, an aerodrome operator must not temporarily close the aerodrome to aircraft operations due to aerodrome works, unless a NOTAM giving notice of the closure is requested and issued not less than 14 days before the closure takes place.
- (9) For non-routine works otherwise requiring a works safety officer to be appointed with contact arrangements as mentioned in subsection 16.07 (2), a nomination of works safety officers in the MOWP for the non-routine works will satisfy the requirement under paragraph 13.01 (c) for a record to be made in the aerodrome manual.

## 15.02 Method of working plans (*MOWPs*)

- (1) A MOWP must:
  - (a) accurately set out the arrangements for carrying out the works; and
  - (b) be prepared in accordance with Chapter 16.
- (2) When preparing a MOWP, an aerodrome operator must consult:
  - (a) air transport operators using the aerodrome; and
  - (b) operators of emergency services aircraft that are likely to operate at the aerodrome during the works period; and
  - (c) ATC (if applicable); and
  - (d) if the MOWP is likely to affect the unit's ability to ensure the safety of aircraft operations at the aerodrome — the ARFF unit at the aerodrome (if any); and
  - (e) if any communications, navigation, surveillance or meteorological infrastructure or equipment would otherwise be affected by the works — the provider of that infrastructure or equipment.

*Note* Consultation with other fixed-base operators at the aerodrome such as flight training organisations, sport aviation organisations, aerial application operators etc. is also recommended.
- (3) Not less than 14 days before works commence, the aerodrome operator must supply a copy of the MOWP to:
  - (a) each operator or organisation mentioned in paragraphs (2) (a) to (e); and
  - (b) the relevant CASA aerodrome inspector (where known), or the local CASA office marked for the attention of an aerodrome inspector.
- (4) A MOWP may only be supplied less than 14 days before works commence if:
  - (a) the works are unforeseen urgent works; and
  - (b) the MOWP states that the works are unforeseen urgent works.

- (5) If a MOWP is amended after it is supplied to the persons mentioned in subsection (3), the amended MOWP must:
  - (a) be supplied to those persons as soon as possible but not later than 48 hours before the works commence; and
  - (b) clearly show the amendment that has been made.
- (6) Aerodrome works for which a MOWP is required must be carried out in accordance with the MOWP, including the MOWP as amended.

### 15.03 Time-limited works

- (1) Aerodrome works may be carried out as time-limited works only if:
  - (a) normal aircraft operations are not disrupted; and
  - (b) the movement area can be restored to normal safety standards; and
  - (c) any hazard created by the works can be removed within 30 minutes of the affected movement area being required for aircraft operations.

*Note* Time-limited works include the following:

- (a) maintenance of markings and lights;
  - (b) grass mowing;
  - (c) rolling of surfaces;
  - (d) sweeping of pavements;
  - (e) minor repairs to pavements;
  - (f) detailed surveys, other than wildlife monitoring activities and serviceability inspections.
- (2) A person must not commence time-limited works that require more than 10 minutes to restore normal safety standards to the movement area and remove obstacles, unless a NOTAM has been issued not less than 24 hours before the works commence stating:
    - (a) the date and time of commencement; and
    - (b) the time required to restore normal safety standards.
  - (3) Time-limited works must be stopped, and normal safety standards restored, if required to allow an aircraft operation to take place.
  - (4) All reasonable measures must be taken to restore normal safety standards not less than 5 minutes before the scheduled or notified time of an aircraft operation.
  - (5) At a non-controlled aerodrome, works that have been stopped to allow the restoration of normal safety standards may be resumed:
    - (a) if stopped for an aircraft arrival — immediately after the arrival, but only if the safety of the aircraft is not endangered by the resumption; or
    - (b) if stopped for an aircraft departure — not earlier than 15 minutes after the departure has taken place; or
    - (c) if stopped for an aircraft arrival that does not take place — not earlier than 30 minutes after the time scheduled or notified for the arrival.
  - (6) At a controlled aerodrome, works which have been stopped to allow the restoration of normal safety standards may, subject to any instructions from ATC, be resumed in



accordance with subsection (5) unless it is not physically possible to comply strictly with subsection (5), in which case compliance must be as close as is reasonably practicable.

*Note* An aerodrome operator may request ATC to vary the time limits specified in paragraph 15.03 (5) (b) for restoring normal safety standards or resuming aerodrome works. Any such variation granted by ATC is subject to any instructions ATC may impose.

#### **15.04 Management and control of aerodrome works**

- (1) An aerodrome operator must appoint a works safety officer with the function of ensuring the safe conduct of aerodrome works.
- (2) The aerodrome operator must be satisfied that the person is able to perform the functions of a works safety officer set out in section 13.04.

*Note* For time-limited works, a dedicated works safety officer is not required if one of the persons carrying out the time-limited works has been trained to perform the function of the works safety officer.

- (3) If aerodrome works are being carried out at an aerodrome while the aerodrome is open and available for any aircraft operations, a works safety officer must be present at all times in the vicinity of the works.
- (4) Procedures for entering works areas must be stated in the MOWP.
- (5) The operator must allow access to works areas only along routes shown in the MOWP or as directed by the works safety officer.

#### **15.05 Runway pavement overlay, reconstruction, resealing or widening works**

- (1) When a runway is to be returned to an operational status following works at the edge of a pavement overlay, reconstruction or widening works, the area where the new and the old runway surfaces meet must not be left with an abrupt vertical surface of more than 25 mm.

*Note* This will normally require the provision of a temporary ramp between the new and the old surfaces.

- (2) The longitudinal slope of any temporary ramp used for subsection (1), measured with reference to the existing runway surface or previous overlay course, must be:
  - (a) 0.5 to 1.0% for overlays up to and including 50 mm in thickness; and
  - (b) not more than 0.5% for overlays more than 50 mm in thickness.
- (3) The entire width of the runway must be overlaid during a single works session. However, if this is not possible:
  - (a) at least the central two-thirds of the width of the runway must be overlaid in the single works session; and
  - (b) a temporary transverse ramp of between 0.8 and 1.0% must be provided between the edge of the new overlay surface and the existing runway surface or previous overlay course, if the difference in levels exceeds 25 mm.
- (4) If it is not possible to achieve the standards described in subsections (2) and (3), different parameters for longitudinal and transverse slopes may be used provided that:
  - (a) the slopes do not cause a hazard for aircraft; and
  - (b) details of the slopes, including the reasons why it is not possible for the standard longitudinal and transverse slopes to be provided, are set out in the MOWP.

- (5) Before a runway that is being overlaid or undergoing resealing works is returned to a temporary operational status, a runway centreline marking conforming to the specifications in this MOS must be provided.
- (6) Despite subsection 9.02 (1), wiring for temporary lighting is permitted above ground level within the manoeuvring area during periods of works provided that:
  - (a) the wiring is not a hazard to aircraft operations; and
  - (b) specific details of the proposed wiring are included in the MOWP.

### **15.06 Works on runway strips**

- (1) Works on runway strips must be carried out in the shortest possible time to minimise the hazard to aircraft operations.
- (2) If works on runway strips are undertaken within 23 m of the edge of the runway then, as far as possible:
  - (a) the works may only be undertaken on one side of the runway at any time; and
  - (b) the works area must not at any time exceed:
    - (i) 9 m<sup>2</sup>; or
    - (ii) for excavations only — a width of 100 mm and a total length of 280 m; and
  - (c) materials and items, for example, gravel, markings and lights left within this part of the runway strip:
    - (i) must not exceed 1 m in height above ground; and
    - (ii) must be removed if the material is likely to be affected by propeller wash or jet blast; and
  - (d) plant and vehicles must vacate the area when the runway is in use.
- (3) If works are undertaken on a runway strip between 23 m from the edge of the runway or runway shoulder and the edge of the graded runway strip, the restrictions mentioned in subsection (2) apply as far as possible, except that:
  - (a) the works area may extend up to an area of 18 m<sup>2</sup> at any one time; and
  - (b) the height of materials may extend up to 2 m.
- (4) If it is not possible to achieve the standards described in paragraphs (2) (a) and (2) (b) and subsection (3), different parameters for the extended works or excavation area may be used provided that:
  - (a) the extended works or excavation area do not cause a hazard for aircraft; and
  - (b) details of the extended works or excavation area, including the reasons why it is not possible for the standard excavation to be provided, are set out in the MOWP.

*Note* The other standards for placement of materials and the requirement to vacate plant and vehicles when the runway is in use still apply.

- (5) If works are to be undertaken in the vicinity of navigational aids, landing aids or meteorological equipment, vehicles or plant associated with the works must not affect the performance of the aids or equipment.

## CHAPTER 16 METHOD OF WORKING PLANS

### 16.01 Introduction

- (1) The MOWP must be presented in sections addressing the following matters in sequence:
  - (a) title page;
  - (b) works information;
  - (c) restrictions to aircraft operations;
  - (d) personnel and equipment;
  - (e) aerodrome markers, markings and lights;
  - (f) any special requirements applicable;
  - (g) administration;
  - (h) authority;
  - (i) drawings;
  - (j) distribution list.
- (2) Each MOWP prepared in a year must be given a reference number consisting of:
  - (a) the code used to identify the aerodrome as published in the AIP-ERSA; and
  - (b) the last two digits of the year; and
  - (c) the number given to the MOWP by the aerodrome operator.
- (3) For paragraph (2) (c), MOWPs issued for an aerodrome must be numbered by the aerodrome operator consecutively in the order of their issue.
- (4) The MOWP title must indicate the location of the works and give a short description of the project.

Example: “[name of aerodrome]: runway 07/25 repairs”.
- (5) The date of the following must be set out on the title page:
  - (a) the approval of the MOWP;
  - (b) the commencement of the MOWP;
  - (c) the expiry of the MOWP;
  - (d) the completion of the works.
- (6) The title page or the following page must also include a table of contents for the MOWP.

### 16.02 Works information

The MOWP must:

- (a) include an outline of the full scope of the works and state which aerodrome facilities are affected; and
- (b) set out for the works:
  - (i) the planned date and time of commencement; and
  - (ii) the duration of each stage; and

- (iii) the time of completion; and
- (c) contain the following sentence:

*“The actual date and time of commencement will be advised by a NOTAM, to be issued not less than 48 hours before work commences”.*

### **16.03 Restrictions to aircraft operations**

- (1) The MOWP must include a “Restrictions to Aircraft Operations” (**RTAO**) section containing the information mentioned in this section.
- (2) The RTAO section must be compiled and presented in a form that enables aircraft operators to readily reference information as it affects them.
- (3) The RTAO section must state:
  - (a) each manoeuvring area restriction; and
  - (b) if different aircraft types are affected differently — each aircraft type affected by the restriction.
- (4) Any restrictions to aircraft operations on the manoeuvring area or in the approach and take-off areas must be listed and shown in the RTAO section using drawings of each stage of the works.

*Note* See also section 16.09.

- (5) When works are being undertaken in more than one stage, a table in the RTAO section must show the restrictions:
  - (a) applicable to each stage of the works; and
  - (b) for each type of aircraft operation.
- (6) The table mentioned in subsection (5) must:
  - (a) outline the various work stages with scheduled start and completion dates; and
  - (b) have a remarks column to list details of special restrictions and the requirements for the issue of NOTAMs.

*Note 1* For paragraph (6) (a), the actual start and completion dates will be notified and updated via NOTAM. See section 15.01.

*Note 2* For changes to the schedule, an amended MOWP will need to be issued. Refer to subsection 15.02 (5).

- (7) The RTAO section must outline details, if any, of special arrangements to be made during works if emergencies or adverse weather conditions occur.
- (8) The RTAO section must set out:
  - (a) the requirements for the restoration of normal safety standards; and
  - (b) any restrictions on the organisation carrying out aerodrome works.
- (9) The RTAO section must include the full text of all planned NOTAMs associated with the aerodrome works.

### **16.04 Personnel and equipment**

- (1) The MOWP must identify or describe any time or circumstances when personnel and equipment are required to vacate the movement area for certain aircraft operations.

Example: “All personnel and equipment will clear runway strip 11/29 for air transport operations not later than XX minutes before 1200 hours.”

- (2) The MOWP must identify:
  - (a) the routes to and from a works area; and
  - (b) the procedures for entering a works area within a movement area.

### **16.05 Aerodrome markers, markings and lights**

- (1) Arrangements for the installation, alteration or removal of aerodrome markers, markings and lights in a works area and in other areas affected by the aerodrome works must be shown in drawings attached to the MOWP.
- (2) A MOWP must set out procedures for ensuring that electrical services and control cables are not damaged during the course of any works.

### **16.06 Special requirements**

The MOWP must provide details of any special requirements arising during or on completion of aerodrome works, for example, arrangements for leaving pavement surfaces swept and clean before evacuation of the works area.

### **16.07 Administration**

- (1) The MOWP must include:
  - (a) the name of the project manager appointed by the aerodrome operator; and
  - (b) the telephone numbers for contacting the relevant individual during and after normal working hours.
- (2) The MOWP must include the contact arrangements for the works safety officer or officers appointed by the aerodrome operator for both during and after normal working hours.

### **16.08 Authority**

- (1) Each MOWP must contain the following statement in a prominent place: “All works must be carried out in accordance with the MOWP”.
- (2) Each MOWP must set out:
  - (a) its expiry date; and
  - (b) any alteration of that date.
- (3) Subject to subsection (4), each MOWP must be authorised and signed by the aerodrome operator’s accountable manager.
- (4) The project manager for the works may sign the MOWP where the aerodrome operator has, in writing, authorised him or her to do so.
- (5) The aerodrome operator must ensure that the MOWP is complied with.

### **16.09 Drawings**

- (1) An MOWP must include drawings to provide a visual reference for each stage of the works, showing the following:
  - (a) specific details of the works area;
  - (b) restrictions to aircraft;

- (c) the location of CNS equipment, including the associated critical or sensitive areas in proximity to the works area;
  - (d) the location of visual ground aids and markings in proximity to the works area, including any unserviceability markers or markings required by the works;
  - (e) details of the height and location of critical obstacles;
  - (f) the location of temporary parts of the movement area (if applicable);
  - (g) access information, including standard routes for vehicles and equipment not normally operated on the aerodrome;
  - (h) storage areas for material and equipment (if applicable);
  - (i) if excavation is required during the works — the location of critical electrical services and control cables which may be disturbed in proximity to the works area.
- (2) Paragraph (1) (i) does not apply if:
- (a) an alternative means of describing the location of the critical electrical services and control cables is provided; and
  - (b) the alternative means is readily available to the works safety officer at all times during the conduct of works; and
  - (c) the alternative means is documented in the MOWP.

## 16.10 Distribution list

The distribution list of the MOWP must include at least the following persons and organisations:

- (a) the project manager;
  - (b) the works safety officer;
  - (c) the aerodrome security manager, if any;
  - (d) the works organiser;
  - (e) CASA;
- Note* MOWPs sent to CASA are normally required to be sent to the assigned aerodrome inspector.
- (f) the aerodrome ATC (if any);
  - (g) the aerodrome ARFF unit (if applicable);
  - (h) the air transport and emergency services aircraft operators using the aerodrome (as applicable);
  - (i) fixed-base operators using the aerodrome (where applicable);
  - (j) CNS service providers located on the aerodrome (where applicable);
  - (k) meteorological service providers located on the aerodrome (where applicable).

## CHAPTER 17 WILDLIFE HAZARD MANAGEMENT

### 17.01 Detection, monitoring and observation

- (1) As part of the aerodrome serviceability inspection, the aerodrome operator must monitor and record at least the following:
  - (a) the presence and behaviour of wildlife on the aerodrome;
  - (b) wildlife activity that is visible:
    - (i) in the vicinity of the aerodrome; or
    - (ii) from the aerodrome.

*Note* For aerodromes with considerable wildlife hazards, a dedicated wildlife inspection, including wildlife counts, is recommended.

- (2) The aerodrome operator, in consultation with the local planning authority, must attempt to monitor sites within 13 km of the aerodrome reference point that attract wildlife.

*Note* For background information, refer to Guideline C of the National Airport Safeguarding Framework, as in force or existing from time to time and freely available from:

[https://infrastructure.gov.au/aviation/environmental/airport\\_safeguarding/nasf/nasf\\_principles\\_guidelines.aspx](https://infrastructure.gov.au/aviation/environmental/airport_safeguarding/nasf/nasf_principles_guidelines.aspx).

- (3) The aerodrome operator must attempt to monitor any reported wildlife aircraft strike events at, or in the vicinity of, the aerodrome.

### 17.02 Wildlife hazard assessment and trigger criteria

- (1) Any detected wildlife hazard must be assessed for its potential risk to aircraft operations.
- (2) If the aerodrome operator has a safety management system, or a risk management plan, mentioned in Chapter 25 or 26 respectively, the assessment must be conducted in accordance with the system or the plan.
- (3) When conducting a wildlife hazard assessment, available data from the following must be considered:
  - (a) wildlife observations;
  - (b) reported aircraft strike events;
  - (c) reported aircraft near miss events.

*Note* If multiple wildlife hazards are identified, CASA recommends that wildlife species be ranked in their order of risk.

### 17.03 Wildlife hazard management plan triggers

- (1) For an aerodrome that, in the course of a financial year, has:
  - (a) 50 000 or more air transport passenger movements; or
  - (b) 100 000 or more aircraft movements;the aerodrome operator must prepare and implement a wildlife hazard management plan.
- (2) The plan must be prepared and implemented not later than 6 months after:
  - (a) for paragraph (1) (a) — the date of publication, by the Department, of the air transport passenger movement numbers indicating that, for the first time under this MOS, there

have been 50 000 or more air transport passenger movements for the aerodrome for the financial year; or

(b) for paragraph (1) (b) — the date the aerodrome operator becomes aware of information indicating that, for the first time under this MOS, there have been 100 000 or more aircraft movements at the aerodrome in the course of the financial year.

(3) If paragraph (2) (a) or (2) (b):

(a) applied to an aerodrome operator; and

(b) subsequently ceased to apply to the operator; and

(c) subsequently would have applied to the operator again if such application were deemed to be for the first time under this MOS;

then the paragraph applies to the operator as if it were for the first time under this MOS.

(4) Subsection (1) does not apply if:

(a) for aerodromes without scheduled international operations — wildlife hazard assessment demonstrates, using statistical and other data, that the wildlife hazard risk is low; and

(b) CASA, in writing, approves the assessment subject to conditions (if any).

*Note* For an aerodrome to which subsection (1) does not apply, but which has a high wildlife hazard management risk, CASA recommends the development of a wildlife hazard management plan.

(5) CASA may direct an aerodrome operator in writing to prepare and implement a wildlife hazard management plan if CASA considers that this is necessary in the interests of aviation safety.

*Note* For CASA directions see regulation 11.245 of CASR. If required in the interests of aviation safety, CASA may revoke an approval given under paragraph (4) (b) and issue a direction under this subsection.

(6) A wildlife hazard management plan must be included in, or referenced in, the aerodrome manual.

*Note* See also section 11.08.

#### **17.04 Preparation of a wildlife hazard management plan**

(1) A wildlife hazard management plan must be prepared in consultation with a suitably qualified or experienced person, for example:

(a) an ornithologist, zoologist, biologist, ecologist; or

(b) a person with demonstrated expertise in the management of wildlife hazards to aviation.

(2) The wildlife hazard management plan must at least:

(a) identify the key aerodrome or contracted personnel and define their responsibilities or functions in the plan; and

(b) identify sources and locations of wildlife attraction:

(i) on the aerodrome; and

(ii) in the vicinity of the aerodrome;

which are likely to cause wildlife to transit the take-off, approach and transitional surfaces; and



- (c) set out the procedures for the following in relation to wildlife hazards:
    - (i) detection;
    - (ii) monitoring;
    - (iii) risk assessment and analysis;
    - (iv) reporting to pilots through the AIP, NOTAM and ATC (if applicable);
    - (v) mitigation, including passive and active strategies; and
  - (d) specify the liaison arrangements for local planning authorities within a radius of at least 13 km from the aerodrome reference point; and
  - (e) set out the aerodrome operator's strategy for wildlife hazard reduction; and
  - (f) include records of the qualifications and experience of key personnel identified in the plan.
- (3) The aerodrome operator must:
- (a) implement the wildlife hazard management plan; and
  - (b) keep the plan under continuous review.
- (4) For subsection (3), a review of the wildlife hazard management plan must be conducted in each of the following circumstances:
- (a) if an aircraft experiences multiple wildlife strikes;
  - (b) if an aircraft experiences substantial damage following any wildlife strike;
  - (c) if an aircraft experiences an engine ingestion of wildlife;
  - (d) if the ongoing presence of wildlife is observed on the aerodrome in size or in numbers reasonably capable of causing an event mentioned in paragraph (a), (b) or (c);
  - (e) at least every 12 months, but if during a period of 12 months the plan was reviewed under paragraph (a), (b), (c) or (d), at least every 12 months after that review.

### 17.05 Wildlife hazard reporting

- (1) If the presence of wildlife is assessed as constituting an ongoing hazard to aircraft, the aerodrome operator must advise the AIS provider in writing to include an appropriate warning notice in the AIP-ERSA in accordance with Chapter 5 of this MOS.

*Note* Reports to the Australian Transport Safety Bureau following a wildlife strike event are also required in accordance with the *Transport Safety Investigation Regulations 2003*.

- (2) Without affecting subsection (1), if a wildlife hazard is assessed as being:
- (a) at a higher risk than usual; and
  - (b) of a short-term or seasonal nature;

then the aerodrome operator must ensure that a timely NOTAM warning of the hazard is given to pilots using the aerodrome.

*Note* See *CASA Advisory Circular (AC) 139.C-16: Wildlife Hazard Management at aerodromes*, as existing from time to time and freely available on the CASA website, for details on what information CASA recommends should be included in the NOTAM.

- (3) Without affecting subsection (1) or (2), if a wildlife hazard is assessed as being a serious and imminent threat to aviation safety at an aerodrome, the aerodrome operator must ensure that pilots using the aerodrome are directly advised on CTAF or UNICOM.

## 17.06 Wildlife hazard mitigation

The aerodrome operator must implement controls to mitigate wildlife hazard risks within the boundary of the aerodrome.

*Note 1* For the management of hazards outside of the aerodrome boundary, see subsection 17.01 (2) and paragraph 17.04 (2) (d).

*Note 2* For the management of hazards from land-based wildlife CASA recommends continuous fencing around the aerodrome boundary, or otherwise containing the movement area.

## 17.07 Training

- (1) Wildlife hazard monitoring and reporting personnel must be trained to competently do the following:
  - (a) conduct wildlife observations and identify high-risk species;
  - (b) assess wildlife populations and describe their behaviour;
  - (c) record information;
  - (d) collect any remains of a wildlife strike on the aerodrome;
  - (e) attempt to facilitate the identification of:
    - (i) any wildlife involved in a strike event; and
    - (ii) any resulting damage to an aircraft;
  - (f) report the outcomes of observation, monitoring and strike collection activities.

*Note* To perform their roles properly, CASA recommends that monitoring personnel have access to wildlife identification materials and equipment such as a field guides, identification books, scopes or binoculars, active management tools, carcass handling tools, identification kits and relevant PPE.
- (2) Personnel engaged in wildlife hazard mitigation must be trained to competently:
  - (a) engage in active wildlife management without causing a hazard to aviation safety; and
  - (b) assess the effectiveness of any mitigation measures that are taken.
- (3) The aerodrome operator must create training records for its monitoring and reporting personnel to show compliance with subsections (1) and (2). Each record must be kept in safe custody for a period of at least 3 years after the record was created.

## CHAPTER 18 PAVEMENT MAINTENANCE

### 18.01 Pavement cleanliness

An aerodrome operator must ensure that all paved runway, taxiway and apron surfaces are kept clear of foreign objects or debris that could cause damage to aircraft.

### 18.02 Runway surface friction or texture

- (1) The aerodrome operator must maintain runways with sealed, concrete or asphalt surfaces in accordance with the surface texture or friction standards specified in section 6.09.
- (2) To measure the friction level of a sealed runway at an aerodrome with scheduled international air transport operations, the aerodrome operator must use an ICAO-accepted continuous friction measuring device with self-wetting features.

*Note 1* Continuous friction measurement is recommended for all aerodromes with runways classified as Code C and above, and for runways with grooves or scoring.

*Note 2* Guidance on evaluating the runway surface friction characteristics is provided in ICAO Document, Assessment, Measurement and Reporting of Runway Surface Conditions (Cir 355). For ICAO documents, see section 1.07.

- (2A) The aerodrome operator must ensure that any person using a friction measuring device mentioned in subsection (2) is demonstrably competent in the use of the device.

*Note* Competence may be demonstrated through appropriate training or experience.

- (3) The wet runway surface friction or surface texture characteristics of a runway must be evaluated as soon as possible after the runway is constructed or resurfaced to determine compliance with section 6.09.
- (4) Technical inspections in the form of periodic friction assessment and surface texture evaluation (as applicable) must be undertaken to identify the need for maintenance or special surface treatment before surface conditions deteriorate below the limits specified in section 6.09.

### 18.03 Water pooling or ponding

If pooling or ponding of water, or poor drainage is observed on a runway in the course of an aerodrome serviceability inspection under paragraph 12.01 (1) (a), the aerodrome operator must ensure that remedial maintenance is undertaken as soon as possible.

*Note 1* Under paragraph 12.01 (1) (a), the operator of a certified aerodrome must carry out an aerodrome serviceability inspection if there has been a severe wind event, a severe storm, or a period of heavy rainfall.

*Note 2* For section 18.03, it is not generally the case that runways or parts of runway surfaces need to be overlaid, resurfaced or replaced, but maintenance action should be taken to address the formation of depressions or surface irregularities that allow water to pool, pond, or not drain.

## CHAPTER 19 COMMUNICATION, NAVIGATION, SURVEILLANCE (CNS) AND METEOROLOGICAL (MET) FACILITIES

### Division 1 General

*Note* CNS and MET facilities at an aerodrome may include all or any of the following:

- (a) Radio navigation facilities, including the following: ILS, DME, VOR, NDB, GBAS;
- (b) surveillance sensor sites, including radar, automatic dependent surveillance – broadcast (ADS-B) and multi-lateration systems;
- (c) air-ground and point-to-point communications systems including radio bearer systems and satellite communications sites;
- (d) air traffic services centres;
- (e) ATC towers;
- (f) meteorological facilities including transmissometers.

#### 19.01 General

- (1) An aerodrome operator must refer to the CNS or MET service provider, for a hazard and impact assessment, any application for development mentioned in sections 19.04 to 19.15 of this MOS that would be:

- (a) within the aerodrome boundary; and
- (b) near, or likely to affect, an existing CNS or MET facility.

*Note 1* The assessment by the CNS or MET service provider will need to determine if the building restricted area for the relevant facility would be infringed by the development, and what hazards may result if the development application proceeds.

*Note 2* CASA recommends that the aerodrome operator monitor, and advise the relevant CNS or MET service provider of, any application for development mentioned in sections 19.04 to 19.15 of this MOS that would be outside the aerodrome boundary, but near, or likely to affect, an existing CNS or MET facility.

- (2) An aerodrome operator must consult the relevant CNS or MET service provider to ensure that:
- (a) adequate provision is made in establishing restricted areas near the CNS or MET facility; and
  - (b) there is adequate control of vehicles and aircraft operations near the CNS or MET facility.

*Note* Control measures may include the use of markers or signage as agreed between the CNS or MET service provider and the aerodrome operator.

- (3) An aerodrome operator must consult the relevant CNS service provider:
- (a) to determine the distance that aerodrome roadways, runways, taxiways and any public roads provided by the aerodrome operator may be constructed from a radio navigation facility; and
  - (b) to ensure that unauthorised personnel and vehicles are kept clear of the facility; and
  - (c) to ensure as far as possible that grazing livestock are kept clear of the facility; and
  - (d) to ensure as far as possible that any suitable materials provided by the aerodrome operator are used in constructing the facility's perimeter fencing and warning signs, bearing in mind that non-metallic materials are preferred.

- (4) An aerodrome operator must consult the relevant surveillance sensor sites service provider:
- (a) to determine the distance that aerodrome roadways, runways, taxiways and any public roads provided by the aerodrome operator may be constructed from the surveillance sensor sites; and
  - (b) to ensure as far as possible that unauthorised personnel and vehicles are kept clear of the facility; and
- Note* Control measures may include the use of markers or signage as agreed between the CNS service provider and the aerodrome operator.
- (c) to ensure as far as possible that suitable materials provided by the aerodrome operator are used in constructing the site's perimeter fencing and warning signs, bearing in mind that non-metallic materials are preferred.
- (5) An aerodrome operator must not proceed with any development proposal mentioned in subsection (1) that is assessed by the CNS or MET service provider at the aerodrome as:
- (a) not meeting the standards in this Chapter for the CNS or MET facility (as the case requires); or
  - (b) likely to create a hazard to aircraft; or
  - (c) likely to impact adversely on the operation of the CNS or MET facility;
- unless:
- (d) a safety case demonstrates how any hazard or adverse impact may be mitigated; and
  - (e) in light of the safety case, the applicable CNS or MET service provider agrees to the development proposal in writing, with or without conditions.
- (6) If there is a line of sight requirement:
- (a) for ATC facilities under Part 172 of CASR; or
  - (b) for ARFF facilities under Subpart 139.H of CASR;
- then the aerodrome operator must actively preserve the required line of sight unless otherwise approved in writing by CASA.

## 19.02 Maintenance

- (1) An aerodrome operator must document procedures for the maintenance of the areas around CNS and MET facilities on the aerodrome.
- (2) The procedures for ground maintenance around the facilities must include consultation with the service provider to ensure that maintenance activities do not interfere with operation of the aid or facility.
- (3) All ground maintenance carried out around CNS and MET facilities must be in accordance with the instructions provided by the CNS and MET service provider.

## 19.03 Installation requirements

Unless it is for air navigation purposes, equipment and installations must not be located in an area to which Chapter 6 or Chapter 7 applies.

## CHAPTER 19

### Division 2 CNS facilities

#### 19.04 Protection of VOR facilities

*Note* There are 2 types of VOR, the Conventional VOR (CVOR) and the Doppler VOR (DVOR). The antenna for either type of VOR may be mounted directly on the ground or on an elevated counterpoise structure. Typically the DVOR type has 48 antennas equally spaced on the circumference of a circle approximately 13.5 m in diameter, and one antenna at the centre of the circle. The DVOR is less susceptible than the CVOR to scalloping effects caused by reflective objects or structures in its vicinity.

- (1) For an elevated CVOR, an aerodrome operator must refer the following for assessment by the navigation service and facility provider responsible for the CVOR:
  - (a) any proposal for development within 200 m of the CVOR antenna;
  - (b) any proposal for development between 200 m and 1 500 m from the centre of the CVOR antenna that exceeds an angle of elevation of 1.5° measured from ground level at the CVOR antenna.
- (2) For a ground-mounted CVOR, an aerodrome operator must refer the following for assessment by the navigation service and facility provider responsible for the CVOR:
  - (a) any proposal for development within 200 m of the CVOR antenna;
  - (b) any proposal for development between 200 m and 1 500 m from the centre of the CVOR antenna that exceeds an angle of elevation of 1.0° measured from ground level at the CVOR antenna.
- (3) For an elevated DVOR, an aerodrome operator must refer the following for assessment by the navigation service and facility provider responsible for the DVOR:
  - (a) any proposal for development within 100 m of the DVOR antenna;
  - (b) any proposal for development between 100 m and 1 500 m from the centre of the DVOR antenna that exceeds an angle of elevation of 2.0° measured from ground level at the centre of the DVOR antenna.
- (4) For a ground-mounted DVOR, an aerodrome operator must refer the following for assessment by the navigation service and facility provider responsible for the DVOR:
  - (a) any proposal for development within 150 m of the DVOR antenna;
  - (b) any proposal for development between 150 m and 1 500 m from the centre of the DVOR antenna that exceeds an angle of elevation of 1.5° measured from ground level at the centre of the DVOR antenna.
- (5) If the type of VOR facility is not known, the aerodrome operator must contact the navigation service and facility provider responsible for the facility for further information.

#### 19.05 Protection of DME facilities

- (1) If a DME antenna is co-located with a VOR, localizer or glide path facility, the building restricted area of the co-located facilities must be considered as the DME building restricted area.

- (2) For a DME that is not co-located as mentioned in subsection (1), an aerodrome operator must refer the following for assessment by the navigation service and facility provider responsible for the DME:
  - (a) any proposal for development within 100 m of the DME antenna that would infringe a horizontal plane located 4 m below the centre of the DME antenna;
  - (b) any proposal for development between 100 m and 1 500 m from the DME antenna that would exceed an angle of elevation of 2.0° measured from the same horizontal plane beneath the DME antenna.

### 19.06 Protection of instrument landing systems (*ILS*)

- (1) An aerodrome operator must consult with the relevant CNS service provider for an ILS to establish and define a building restricted area that ensures no component of the ILS is adversely affected by:
  - (a) electromagnetic interference; or
  - (b) the presence or construction of buildings; or
  - (c) the presence of temporary or permanent structures.
- (2) An aerodrome operator must refer any development proposal that infringes the building restricted area of a localizer, a glide path or a localizer far field monitor for assessment by the responsible navigation service and facility provider for the ILS.

#### *Notes*

1. Electromagnetic interference (EMI) can be produced by a variety of sources including, for example, power lines, substations, electric welding, radio frequency (*RF*) welding, RF curing and some industrial-scientific-medical equipment.
  2. Buildings and other structures can reflect ILS signals in unwanted directions, causing interference and distorting the information provided to aircraft.
  3. For aerodrome planning, CASA recommends that aerodrome operators should consult the relevant navigation service and facility provider to ensure adequate provision is made for ILS installations and the necessary critical and sensitive areas.
- (3) An aerodrome operator must consult with the relevant navigation service and facility provider to establish and define appropriate:
    - (a) ILS critical areas for each ILS installation; and
    - (b) ILS sensitive areas for CAT I, SA CAT I, CAT II, SA CAT II and CAT III ILS installations.

*Note 1* The size and shape of a critical or sensitive area depends on the characteristics of the particular ILS system and the configuration of the particular environment.

*Note 2* A critical area may be separately established for vehicles and aircraft of particular sizes.

- (4) The aerodrome operator must liaise with the relevant navigation service and facility provider to ensure that the boundaries of each ILS critical area are marked by suitable signs and visual markers to prevent unauthorised access from vehicles and persons.
- (5) The aerodrome operator must place signs at each road access point to an ILS critical area to warn drivers and pedestrians against entering the area without authority.
- (6) The aerodrome operator must not permit:
  - (a) vehicles and plant to enter, or remain in, an ILS critical area while the ILS is in use; or

- (b) construction access or variation to such access within an ILS critical area unless the access or variation has been coordinated with the relevant navigation service and facility provider.
- (7) When vehicle access to an ILS critical area is required for a particular purpose, an aerodrome operator must:
- (a) liaise with the navigation service and facility provider for the ILS to be temporarily withdrawn from service, unless otherwise authorised by ATC; and
  - (b) arrange for notification via ATC or via a NOTAM (as applicable) to inform pilots of the temporary withdrawal.

*Note 1* Access to the ILS critical area would come under control where ATC is provided.

*Note 2* An example of a particular purpose is grass cutting or other vegetation management activities.

- (8) If low-visibility procedures are in effect at an aerodrome, the aerodrome operator must not permit vehicles or plant to enter, or remain in, an ILS critical area unless ATC has given the operator specific clearance for the vehicles or plant to enter or remain.

### **19.07 Protection of marker beacons**

For marker beacons, an aerodrome operator must refer the following for assessment by the navigation service and facility provider responsible for the beacons:

- (a) any proposal for development within 5 m of the marker beacon antenna;
- (b) any proposal for development between 5 m and 50 m from the marker beacon antenna that exceeds an angle of elevation of 50° measured from ground level at the base of the marker beacon antenna.

### **19.08 Protection of non-directional beacons (NDBs)**

- (1) For NDBs, an aerodrome operator must refer the following for assessment by the navigation service and facility provider responsible for the NDB:
- (a) any proposal for development within 60 m of the NDB antenna;
  - (b) any proposal for development between 60 m and 300 m from the centre of the NDB antenna that exceeds an angle of elevation of 5° from ground level at the centre of the NDB antenna.

*Note* Within 60 m of the centre of the NDB antenna, generally there should be no obstacles except for essential infrastructure such as the equipment building, antenna support towers and site fencing, and vegetation should be kept below a height of 0.6 m. Overhead low-voltage power lines and telephone lines serving the NDB should be kept at least 60 m from the centre of the NDB antenna. Power and telephone lines should be underground within 60 m of the centre of the NDB antenna.

- (2) The following are not permitted over or on the earth mat area associated with the NDB:
- (a) ploughing;
  - (b) livestock (other than sheep).

### **19.09 Protection of ground-based augmented systems (GBASs)**

- (1) For a GBAS, the aerodrome operator must refer the following for assessment by the navigation service and facility provider responsible for the GBAS:
- (a) any proposal for development within 200 m of the VDB antenna;



- (b) any proposal for development between 200 m and 3 000 m from the VDB antenna that exceeds an angle of elevation of 0.9° measured from ground level at the base of the VDB antenna.
- (2) For the RSMU antenna, the aerodrome operator must refer the following for assessment by the navigation service and facility provider responsible for the antenna:
  - (a) any proposal for development within 155 m of the RSMU antenna;
  - (b) any proposal for development between 155 m and 3 000 m from the RSMU antenna that exceeds an angle of elevation of 3° measured from ground level at the base of the RSMU antenna.

### 19.10 Protection of radar sensor sites

- (1) For any site within the aerodrome boundary that is used to monitor a primary, secondary or en route radar, the aerodrome operator must refer for assessment by the navigation service and facility provider any proposal for development that is:
  - (a) within 500 m of the site’s monitoring antenna, limited to a sector  $\pm 45^\circ$  either side of the line of sight to the radar; and
  - (b) 4 m or more above the height of the site monitoring antenna.

*Note 1* All buildings and fences within and below the 4 000 m limit degrade the performance of the sensor. If possible, these obstructions should be avoided. Reflection minimisation techniques may be used to reduce the interference to a minimum, for example, RF traps, use of trees and shrubs, no fences tangent to the sensor.

*Note 2* For further background details on the “area of interest” for radar monitoring sites, see Guideline G of the National Airport Safeguarding Framework, as in force or existing from time to time and freely available on the CASA website.

- (2) For power lines and electrical transmissions within the aerodrome boundary which may cause interference with radar surveillance sensors, the following restrictions apply:
  - (a) all overhead power lines within 1 km of a radar surveillance sensor must be aligned radially from the radar or be located at least 10° below horizontal from the antenna;
  - (b) no radio interference emitters (for example, welders and electrical transmission lines) having any component of transmission in the radar frequency band are permitted within 2 km of a radar surveillance sensor;
  - (c) no overhead electrical transmission line with a line capacity mentioned in a row of column 1 of Table 19.10 (2) is permitted within the distance from a radar surveillance sensor mentioned in the same row in column 2.

**Table 19.10 (2) Minimum overhead electrical transmission line distance from aerodrome boundary**

Line capacity	Distance
2 kV – 22 kV	400 m
22 kV – 110 kV	1 km
Above 110 kV	2 km

### 19.11 Protection of wide area multilateration (WAM) and automatic dependent surveillance – broadcast (ADS-B) sensors

For WAM and ADS-B sensors, the aerodrome operator must refer the following for assessment by the navigation service and facility provider responsible for the WAM or ADS-B sensor:

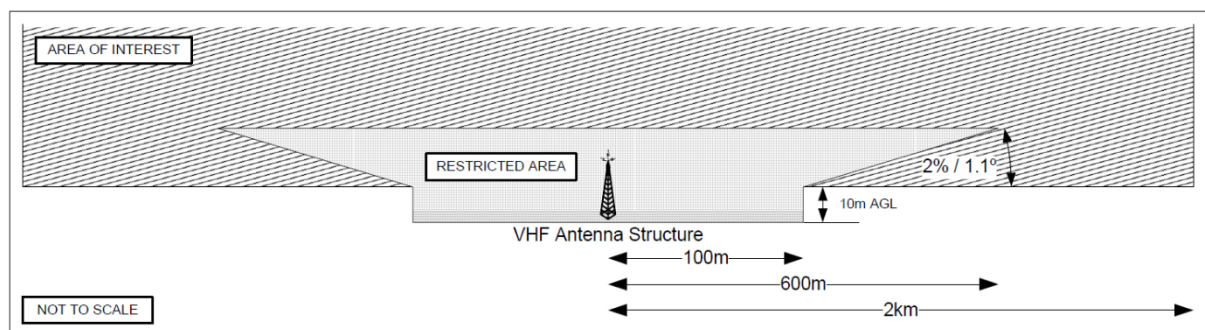
- (a) any proposed development within a 100 m radius from the antenna base that would exceed the height (the **mentioned height**) that is 1 m below the sensor antenna base (the **building restricted area critical zone**) but excluding buildings, trees, power and telephone lines, and fences that do not project above the mentioned height;
- (b) any proposed development between 100 m and 1 500 m of the sensor that would exceed an angle of elevation of  $1^\circ$  measured from the centre of the sensor (the **building restricted area sensitive zone**).

*Note* Large obstructions, for example, multi-storey buildings, steel bridges and wind turbines, are potential sources of interference to correct operation. For a new installation, CASA recommends that the installation should be kept at least 1 500 m clear of these types of structures.

### 19.12 Protection of VHF/UHF communication facilities

*Note* Reliable VHF/UHF communications require a clear line-of-sight path between the base station and aircraft and vehicles using the facilities. The construction of buildings or towers can prevent reliable communications. The Area of Interest for the VHF/UHF facilities includes all developments between 100 m and 2 000 m that exceed a height of 10 m above ground level at the base of the VHF/UHF antenna.

- (1) For VHF/UHF communications facilities, the aerodrome operator must refer the following for assessment by the navigation service and facility provider responsible for the facilities as illustrated in Figure 19.12 (1):
  - (a) any proposed development, pole, antenna, welding, surveying, construction or crane operation within 100 m of the centre of the VHF/UHF antenna (the **restricted area**);
  - (b) any proposed development between 100 m and 600 m from the centre of the antenna that would exceed an angle of elevation of  $1.1^\circ$  from 10 m above ground level (measured at the centre of the antenna) and then extending out to a distance of 2 000 m from the centre of the antenna, including the area above the restricted area (the **area of interest**).
- (2) If there is overlap between the restricted area and area of interest illustrated in Figure 19.12 (1), the restricted area takes precedence over the classification for all included areas.
- (3) Within the area of interest, all developments, except those concerning light poles and crane operations, must be referred for assessment to the communications service and facility provider responsible for the system.

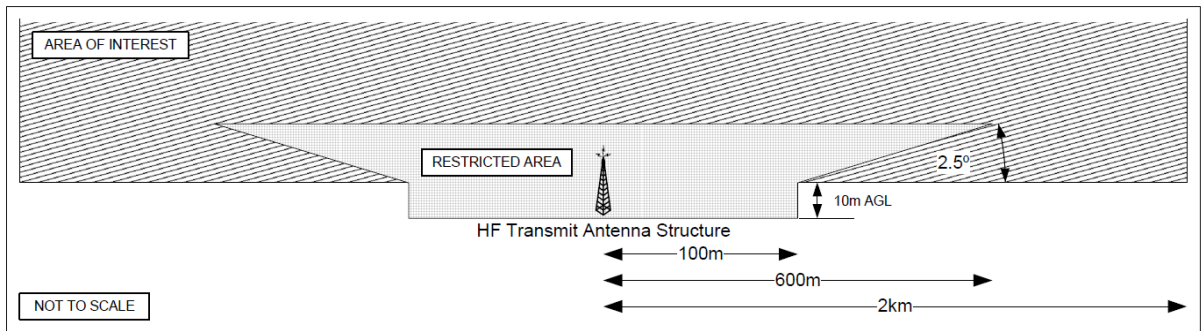


**Figure 19.12 (1) VHF facility restricted area and area of interest (illustrates matters)**

### 19.13 Protection of HF communication facilities

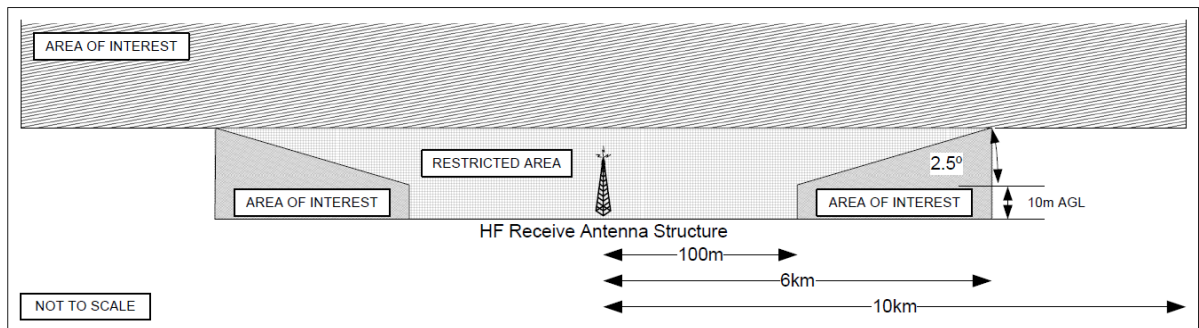
*Note* For HF transmit antennas, to ensure that the HF antenna performance is not compromised, substantial structures are generally prohibited within the restricted area, however, simple vertical towers and masts of any height may be acceptable beyond 100 m from the centre of the antenna.

- (1) For HF communications facilities, the aerodrome operator must refer the following for assessment by the communications service and facility provider responsible for the HF transmit antenna, as illustrated in Figure 19.13 (1):
  - (a) any proposed development, pole, antenna, welding, surveying, construction or crane operation within 100 m of the antenna (the **restricted area**);
  - (b) any proposed development between 100 m and 600 m from the centre of the antenna that would exceed an angle of elevation of 2.5° from 10 m above ground level at the centre of the antenna, including the area above the restricted area (the **area of interest**).



**Figure 19.13 (1) HF transmit facility restricted area and area of interest (illustrates matters)**

- (2) For an HF receive antenna, the aerodrome operator must refer the following for assessment by the communications service and facility provider responsible for the HF receive antenna, as illustrated in Figure 19.13 (2):
  - (a) any proposed development, pole, antenna, welding, surveying, construction or crane operation within 100 m of the antenna (the **restricted area**);
  - (b) any proposed development between 100 m and 600 m from the centre of the antenna that would exceed an angle of elevation of 2.5° from 10 m above ground level at the centre of the antenna, including the area above the restricted area (the **area of interest**).



**Figure 19.13 (2) HF receive facility restricted area and area of interest (illustrates matters)**

### 19.14 Protection of satellite ground stations (SGSs)

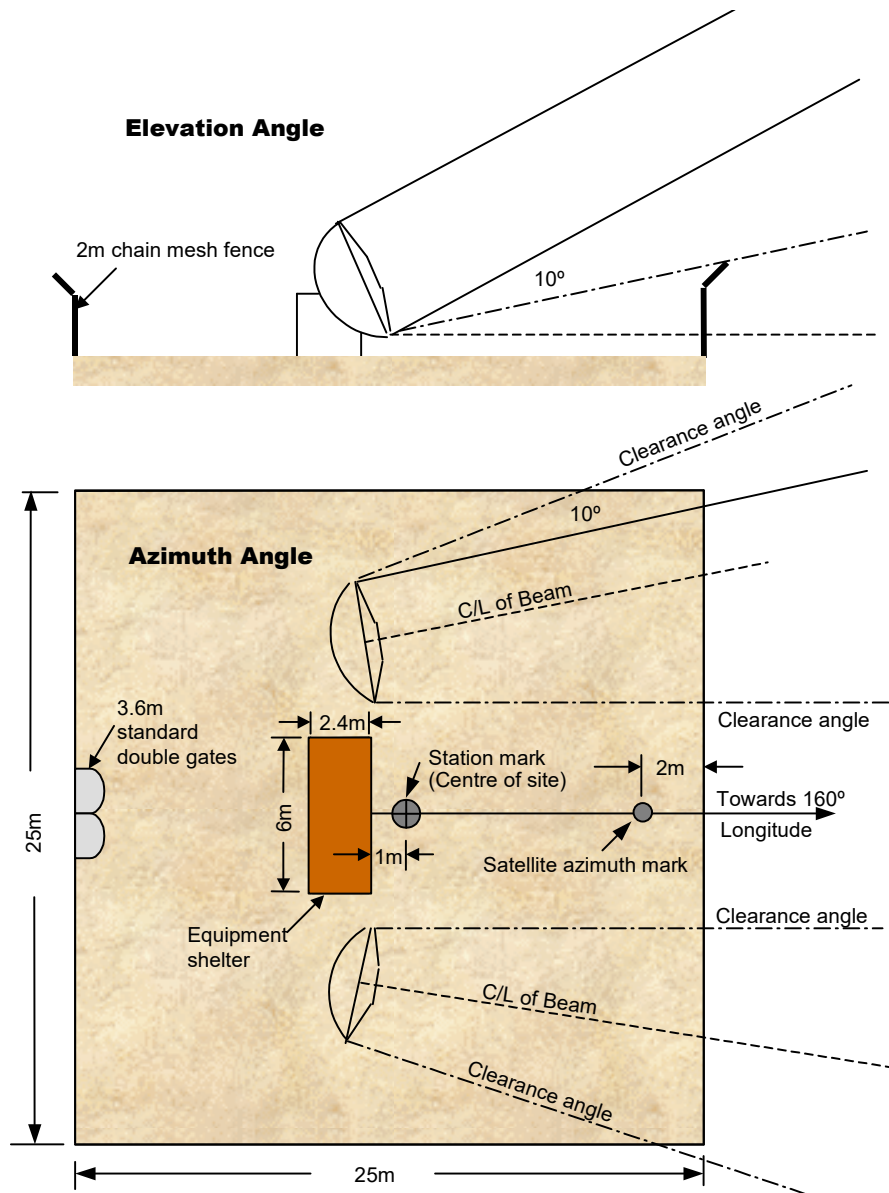
- (1) An SGS antenna within an aerodrome boundary must have a clear line of sight to:
  - (a) the intended operating satellite on the geostationary arc; and
  - (b) an alternative satellite that may be used following a failure of, or to substitute for, the intended operating satellite.
- (2) Unless otherwise advised by the SGS service and facility provider (*the provider*), the aerodrome operator must ensure that an SGS antenna is sited to allow alignment to any satellite located on the geostationary arc between 122 and 172 East longitude (corresponding to Asiasat4 and GE23).

*Note* This is the arc of potential interest to Airservices Australia and will result in an angle of elevation greater than 20° for any site in Australia.

- (3) The provider must ensure that the minimum clearance, from the edge of the antenna to any proposed development referred for assessment under section 19.01, is as follows with reference to the bore sight of the antenna for all possible satellites, as shown in Figure 19.14 (3):
  - (a) 10° — for all electrically-passive items; and
  - (b) 30° — for any electrically-active items;

*Note* CASA recommends that minor obstructions such as guy wires should be avoided if possible but will usually have minimal impact on the performance of large antennas. Allowance should be made for aircraft flight paths which may intersect the antenna beam at close range. If possible, antennas should be located to ensure that aircraft do not cross through the bore sight when on the ground or at low altitudes.

- (4) The aerodrome operator must refer any proposed development to the provider for assessment if the development would be:
  - (a) both:
    - (i) within 0 m and 30 m of the SGS; and
    - (ii) within  $\pm 90^\circ$  azimuth from True North centred on the SGS, regardless of the height; or
  - (b) all of the following:
    - (i) between 30 m and 150 m of the SGS;
    - (ii) within  $\pm 90^\circ$  azimuth from True North centred on the SGS;
    - (iii) greater than 10 m high when measured from the ground at the base of the SGS site.



**Figure 19.14 (3) Communications satellite ground station manned centre site (shows matters)**

### 19.15 Protection of microwave links

- (1) Equipment microwave links associated with CNS within an aerodrome boundary must have clear line of sight to any object, structure or development which may then need to be referred for assessment, in order to transmit aviation information from remote stations back to ATC.
- (2) The aerodrome operator must refer any proposed development to the microwave link system to the microwave service and facility provider for assessment if the development would be within 50 m of the line of sight mentioned in subsection (1).
- (3) If the aerodrome operator does not know the location of microwave links, the operator must contact the system authority for information and guidance as to locations.

## 19.16 Siting requirements for CNS facilities

*Note* CASA recommends that for new and existing facilities, this section should be considered with the engineering, technical and instruction manuals associated with the required function and protection of the CNS facility.

- (1) Subject to section 7.02, this section applies only in relation to the siting of CNS facilities within an aerodrome boundary.
- (2) Unless required for air navigation or aircraft safety, equipment or an installation that could endanger an aircraft in the air or on the ground must not be located:
  - (a) on a runway strip; or
  - (b) in a runway end safety area; or
  - (c) on a taxiway strip; or
  - (d) within the distance specified in Row 2 in Table 6.53 (1)-2 as applicable for the relevant taxiway code letter; or
  - (e) in a clearway.
- (3) Equipment or an installation required for air navigation or for aircraft safety, which is located on any of the following, must be frangible and mounted as low as possible to the surrounding ground level:
  - (a) that portion of a runway strip within:
    - (i) where the code number is 3 or 4 — 75 m of the runway centreline; or
    - (ii) where the code number is 1 or 2 — 45 m of the runway centreline;
  - (b) a runway end safety area, a taxiway strip, or within the distances specified in Table 6.53 (1)-2 as applicable for the relevant taxiway code letter;
  - (c) a clearway if it would otherwise endanger an aircraft in the air.

*Note* CASA recommends that any equipment or installation required for air navigation or aircraft safety which must be located on the non-graded portion of a runway strip should be regarded as an obstacle and should be frangible and mounted as low as possible.

- (4) Unless its function requires it to be there for air navigation or aircraft safety, equipment or an installation must not be located within the following distances from a precision approach runway nominated as CAT I, II or III:
  - (a) 240 m of the end of the runway strip;
  - (b) where the code number is 3 or 4 — 60 m of the extended centreline;
  - (c) where the code number is 1 or 2 — 45 m of the extended centreline.
- (5) Equipment or an installation required for air navigation or aircraft safety which is located on or near a strip of a precision approach runway nominated as CAT I, II or III must be frangible and mounted as low as possible if:
  - (a) for code number 4 and code letter F — it is situated on that portion of the strip within 77.5 m of the runway centreline; or
  - (b) it is:
    - (i) situated within 240 m of the end of the strip; and

- (ii) it is situated within:
  - (A) for code number 3 — 460 m of the extended runway centreline; or
  - (B) for code number 1 or 2 — 45 m of the extended runway centreline; or
- (c) it penetrates any of the following:
  - (i) the inner approach surface;
  - (ii) the inner transitional surface;
  - (iii) the baulked landing surface.

## CHAPTER 19

### Division 3 Meteorological facilities

#### 19.17 Protection of meteorological facilities

*Note* For background information, the following are set out in the MET section of the AIP, as in force or existing from time to time and freely available on the Airservices Australia website: the location and configuration of the Bureau of Meteorology weather information station sites, their phone numbers and VHF broadcast frequencies (if relevant). Instruments used to measure meteorological parameters are generally co-located within an instrument enclosure which may contain a variety of instruments.

- (1) This section applies only in relation to instrument enclosures within an aerodrome boundary.
- (2) An aerodrome operator must refer any proposed development in or around a buffer zone or instrument enclosure to the provider of the meteorological facilities within the instrument enclosure for assessment of whether the development would adversely affect the operation of the facilities.

*Note* The buffer zones are described in section 19.18.

- (3) Herbicides and weed sprays must not be used in the vicinity of an instrument enclosure if this would result in the natural vegetation within the enclosure being exposed to the herbicide or spray.
- (4) For the buffer zone and the instrument enclosure, concrete or asphalt walkways:
  - (a) may be installed where the surface is likely to be rendered impassable or unsafe in wet conditions; and
  - (b) if installed, must be:
    - (i) no wider than 0.5 m; and
    - (ii) kept to a minimum consistent with reasonable accessibility to the instrument area.
- (5) The instrument enclosure must not be artificially watered by a source located outside the enclosure.

#### 19.18 Siting requirements for meteorological facilities

*Note* CASA recommends that for new and existing facilities, this section should be considered with the engineering, technical and instruction manuals associated with the required function and protection of the meteorological facility.

- (1) This section applies only in relation to the siting of meteorological facilities within an aerodrome boundary by the MET service provider as authorised under the regulations.
- (2) The site of a standard instrument enclosure within an aerodrome boundary must:
  - (a) be at least a 16 m by 16 m square enclosure (*instrument enclosure*) in the middle of a 30 m by 30 m square buffer zone (*buffer zone*) aligned in the True North – South direction; and
  - (b) take account of the exposure requirements of the most sensitive instrument to be installed in the instrument enclosure and the purpose of the installation, as advised by the MET service provider.



- (3) The instrument enclosure must be as follows:
  - (a) level;
  - (b) clearly defined;
  - (c) as densely covered with the natural vegetation typical of the surrounding area as is the surrounding area itself;
  - (d) maintained to a height of no more than 50 mm.
- (4) The instrument enclosure must not be artificially watered.
- (5) The outdoor instruments installed inside the instrument enclosure must be on a level piece of ground:
  - (a) whose surface is covered with short grass or is a surface representative of the locality; and
  - (b) surrounded by open fencing or palings to exclude unauthorised persons.
- (6) The instrument enclosure area must not be top-dressed with any material that is inconsistent with the surrounding surface type.
- (7) The buffer zone around an instrument enclosure must:
  - (a) be covered by the natural vegetation or ground cover of the region; and
  - (b) have the vegetation or ground cover maintained to a height of approximately 0.5 m.
- (8) Any isolated obstruction under 15 m in height (for example, a mast, a post or a tree) must be at least 4 times the height of the obstruction distant from any point in the instrument enclosure.
- (9) Subsection (7) also applies to the aerodrome weather station electronics unit, if installed.
- (10) Subject to subsection (8), any obstruction that:
  - (a) is 15 m or more in height, or that is in the form of a shed or a similar built structure; and
  - (b) covers more than 45° of azimuth;
 must be at least 10 times the height of the obstruction distant from any point in the instrument enclosure.
- (11) Subsection (8) does not apply to an isolated mast which:
  - (a) is of a diameter or width so small that it does not obstruct direct solar radiation from falling on the instrument enclosure; and
  - (b) lies down-wind of the prevailing winds to mitigate the risk of producing rain shadows.

## CHAPTER 20 EARTHING POINTS

### 20.01 Ground earthing points

- (1) An aerodrome operator may provide ground earthing points at an aerodrome, and if provided, the resistance to earth must not exceed 10 000 ohms.

*Note* If a ground earthing point is provided, CASA recommends that it should only be provided in consultation with the aerodrome fuelling agent.

- (2) Each ground earthing point on the apron must be tested for its electrical resistance:
  - (a) as part of the initial installation; and
  - (b) when it is being replaced; and
  - (c) 6 months after the installation; and
  - (d) 6 months after any replacement; and
  - (e) otherwise as part of the aerodrome technical inspection.
- (3) Without affecting subsection (2), each ground earthing point on the apron must be visually inspected not later than every 3 months after the commencement of this MOS, to ensure that:
  - (a) the ground earthing point is:
    - (i) firmly connected to the earthing rod; and
    - (ii) seated on the pavement; and
  - (b) the earthing rod is firmly embedded in the ground; and
  - (c) the fins used for making electrical connections are free from dirt, grease, paint, or any other contaminating substance; and
  - (d) no ground earthing points have been buried or removed.

*Note* Visual inspections under subsection (3) are additional to the tests otherwise required for electrical resistance under subsection (2).

- (4) If testing shows that the ground earthing points are sound, they must be marked with a 15 cm diameter circle, coloured white.
- (5) If :
  - (a) the resistance to earth exceeds 10 000 ohms; and
  - (b) the ground earthing point cannot immediately be repaired or replaced;then the head of the ground earthing point must be:
  - (c) removed; or
  - (d) marked with a 15 cm diameter circle, in red, to show that it is not to be used.

## CHAPTER 21 LIGHT AIRCRAFT TIE-DOWN FACILITIES

### 21.01 Tie-down facilities

- (1) An aerodrome operator may provide tie-down facilities at an aerodrome only if they are of a sufficient strength to securely hold down the aircraft type for which they are provided.

*Note* CASA recommends that the design of the tie-down facilities should be determined in consultation with an engineering consultant or manufacturer of the anchor system.

- (2) Tie-down facilities:
  - (a) must be fixed to the ground using embedded anchors; and
  - (b) must not be left loose on the surface of the aerodrome.
- (3) For subsection (2) anchors must be:
  - (a) flush with the surface wherever possible; and
  - (b) not more than 25 mm above ground level.

## CHAPTER 22 RADIO COMMUNICATION FACILITIES

### 22.01 Certified air/ground radio service (CA/GRS)

- (1) A CA/GRS at an aerodrome must provide the following services to aircraft within airspace designated by CASA:
  - (a) advice on relevant air traffic in designated airspace or on the aerodrome;
  - (b) aerodrome weather and operational information, including the following:
    - (i) wind speed and direction;
    - (ii) the runway preferred by wind or noise abatement requirements;
    - (iii) runway surface conditions;
    - (iv) QNH;
    - (v) temperature;
    - (vi) cloud base and visibility;
    - (vii) present weather;
    - (viii) other operational information;
    - (ix) for departing aircraft — time check;
    - (x) call-out of the aerodrome emergency services;
    - (xi) aerodrome information to pilots who telephone the service.
- (2) A CA/GRS may only be provided by a certified air/ground radio operator (a **CA/GRO**).
- (3) An applicant for certification as a CA/GRO for this section must hold:
  - (a) a flight radio operator licence or an approval under Part 64.B of CASR; and
  - (b) a Bureau of Meteorology Class A or B weather observer's qualification;and must also hold or have held:
  - (c) an ICAO-recognised air traffic controller licence; or
  - (d) an Australian Defence Force qualification equivalent to an air traffic control licence; or
  - (e) an Australian flight service officer licence; or
  - (f) a CA/GRO certificate previously issued by CASA.
- (4) Without affecting subsection (1), a CA/GRO may provide aviation information requested by pilots.

*Note* The decision to use, or not to use, the aviation information provided by a CA/GRO rests with the pilot in command.
- (5) A CA/GRS permanently located at an aerodrome must be provided with the following facilities and documentation:
  - (a) a suitable work area that provides the CA/GRO with:
    - (i) as far as practicable, a full view of the manoeuvring area and circuit area; and
    - (ii) a view of the manoeuvring area and the approaches to the runways;
  - (b) two-way VHF radio communications;

- (c) an automatic aerodrome information service (an *AAIS*);
- (d) a telephone;
- (e) a means of receiving NOTAMs;
- (f) meteorological instruments that meet both Bureau of Meteorology standards as in force or existing from time to time, and ICAO Annex 3, Meteorological Service for International Air Navigation standards as in force or existing from time to time, for the purpose of providing the following meteorological information:
  - (i) wind direction and speed (2 minute averaging) with measurement accuracy to be: direction  $\pm 5^\circ$ ; speed  $\pm 1$  kt up to 20 kt, and  $\pm 5\%$  above 20 kt;
  - (ii) QNH (measured to within 0.1 hPa and rounded down to the next whole integer; for example, 1010.9 hPa is reported as 1010 hPa);
  - (iii) air temperature (measured to within 0.5 degrees Celsius and rounded up to the next whole degree Celsius, for example, 12.5 degrees C is reported as 13 degrees C);
- (g) current aeronautical documentation, NOTAMs, and charts appropriate to IFR and VFR operations within the CTAF of the aerodrome;
- (h) the aerodrome emergency plan (*AEP*).

*Note* Bureau of Meteorology standards for relevant aviation instruments are contained in ICAO Annex 3, Meteorological Service for International Air Navigation. For ICAO documents, see section 1.07.

- (6) A CA/GRO, in performing CA/GRO functions, must use the standard aviation communication techniques and phraseology set out in the AIP.
- (7) A CA/GRS call-sign must be the location name of the aerodrome followed by the word “Radio”.
- (8) Aerodrome information must be broadcast on the AAIS in the following order:
  - (a) preferred runway;
  - (b) wind direction and speed;
  - (c) runway surface conditions;
  - (d) QNH;
  - (e) temperature;
  - (f) cloud base and visibility;
  - (g) present weather or CAVOK;
  - (h) aerodrome operational information.

## 22.02 Aerodrome frequency confirmation system (AFCS)

- (1) The operator of a non-controlled aerodrome with more than 10 scheduled air transport movements per week must provide a ground-based aerodrome frequency confirmation system (*AFCS*).

*Note* An AFCS may be used in conjunction with a pilot-activated lighting system.

- (2) The requirement under subsection (1) may be satisfied by one of the following facilities:
  - (a) an aerodrome frequency response unit (*AFRU*);
  - (b) a UNICOM service;
  - (c) a CA/GRS.

### 22.03 Operation of UNICOM or CA/GRS

If a UNICOM or CA/GRS is provided, it must operate for the period 30 minutes before arrival to 30 minutes after departure of each scheduled air transport operation.

*Note* See also section 22.06.

### 22.04 Aerodrome frequency response unit

- (1) If an AFRU is provided, and if a transmission, whether a radio broadcast or an unmodulated carrier burst, is made from an aircraft operating within radio range of the AFRU on the aerodrome frequency, then the AFRU must:
  - (a) be able to detect the presence of aircraft VHF carrier transmissions of 2 seconds or more duration; and
  - (b) at the end of the transmission — automatically respond with one of the following types of transmissions on the aerodrome frequency:
    - (i) a pre-recorded short voice message, if there has been no other received aircraft transmissions in the previous 5 minutes;  
*Note* The pre-recorded short voice message normally takes the form of the aerodrome name.
    - (ii) a short (300 ms) tone burst if any transmissions have been received in the previous 5 minutes.

(2) Additional safety related aerodrome information may also be included in the AFRU voice message.

(3) For any transmissions which consist of 3 sequential carrier bursts over a 5 second period, the AFRU must be able to do the following regardless of radio transmission activity in the previous 5 minutes:

- (a) detect the transmissions;
- (b) respond to them in accordance with paragraph (1) (b).

(4) The AFRU must meet the technical requirements of, and be certified as complying with, the Australian Communications and Media Authority Equipment Compliance Requirements ECR 203A for Amplitude Modulated Transmitter/Receivers (Base and Mobile) for 25 kHz Carrier Frequency Separation in the Aeronautical Frequency Band 118 - 137 MHz, as in force or existing from time to time.

*Note* The Australian Communications and Media Authority Equipment Compliance Requirements mentioned in subsection (4) are freely available on the Federal Register of Legislation.

(5) Frequency coverage for the AFRU must be in the range 118.000 to 136.975 MHz at 25 kHz separation.

(6) The receiver must be:

- (a) set for a sensitivity of at least 15  $\mu$ V; and
- (b) adjusted to a higher value in the case of nuisance activation or other interference.

(7) The AFRU must have a minimum capacity of 8 seconds for the recorded voice message.

(8) The AFRU audio transmissions must be clear and intelligible.

(9) The length of carrier transmission must not exceed the AFRU recorded voice message time.

*Note* The carrier must not continue after the voice modulation ceases.

- (10) The transmitted recorded voice message or the tone burst of the AFRU must commence less than 500 milliseconds after the end of the aircraft transmission.
- (11) The transmitter beepback tone of the AFRU must be a 1 000 Hz, 300 millisecond tone burst.
- (12) If the primary power supply for the AFRU fails, the power source must automatically change over to a stand-by power supply capable of operating the unit without interruption for 24 hours.

*Note* CASA recommends that, unless the expected aircraft traffic and resultant transmission volume at an aerodrome are known, the transceiver should be able to facilitate, at a minimum, 2 voice responses per hour during the 24 hour period.

- (13) In the event of an internal fault that results in continuous or jammed transmission of the VHF carrier, the AFRU must:
  - (a) internally detect the continuous or jammed transmission within 1 minute; and
  - (b) shut down or recycle the unit.

### **22.05 Power supply and changeover indications**

Either of the following:

- (a) the external housing of the AFRU;
- (b) remote monitoring of the AFRU;

must provide an indication of:

- (c) the presence or failure of the primary power supply; and
- (d) whether a changeover has occurred to operation on the stand-by supply.

### **22.06 UNICOM services**

- (1) UNICOM (universal communications) services:
  - (a) are non-ATS radio communication services provided on an aerodrome CTAF to enhance the value of information normally available about a non-controlled aerodrome; and
  - (b) being a secondary use of CTAF, must not inhibit the exchange of aircraft-to-aircraft traffic information.

*Note* The primary function of the CTAF frequencies used by UNICOM services is to enable pilots to exchange traffic information for aircraft separation purposes.

- (2) A UNICOM service is not a CA/GRS.
- (3) An aerodrome operator's use of UNICOM services, whether as a frequency confirmation system or otherwise, must be limited to the exchange of radio messages concerning the following:
  - (a) confirmation of the CTAF frequency selected by aircraft;
  - (b) general aerodrome weather reports;
  - (c) aerodrome information;
  - (d) estimated times of arrival and departure;
  - (e) passenger requirements;
  - (f) aircraft refuelling arrangements;

- (g) maintenance and servicing of aircraft, including the ordering of urgently required parts;
  - (h) unscheduled landings by aircraft.
- (4) General aerodrome weather reports provided by a UNICOM operator must be limited to simple, factual statements about the weather, unless the operator is authorised by CASA to make meteorological observations.



## CHAPTER 23      LOW-VISIBILITY OPERATIONS

### 23.01 Introduction

- (1) For the safety of aircraft operations in conditions of reduced visibility or low cloud, the operator of a controlled aerodrome must establish low-visibility procedures (*LVP*) in accordance with this Chapter.

*Note* Aircraft operations at aerodromes during reduced visibility or low cloud conditions present additional hazards to the aircraft and other aerodrome users. As visibility reduces, the ability of air traffic service staff, pilots, vehicle drivers and other personnel to identify hazards and take remedial action in a timely manner becomes limited. In conditions of low cloud, the time available for the pilot of an approaching aircraft to assess the aerodrome environment visually is reduced.

- (2) For the safety of low-visibility aircraft departures during conditions of reduced visibility or low cloud, the operator of a non-controlled aerodrome may establish LVP in accordance with this Chapter.

### 23.02 Development of low-visibility procedures (LVP)

LVP must:

- (a) be the subject of proper consultation with any party likely to be affected by them, including aircraft operators, ATC and aerodrome service providers; and
- (b) take into account local conditions; and
- (c) as a minimum, include procedures for the following:
  - (i) identifying the specific circumstances in which LVP measures are to be initiated, fully implemented and terminated;
  - (ii) supporting the nominated rate of aerodrome movements;
  - (iii) training and authorisation for airside drivers and other personnel to operate airside during the operation of LVP;
  - (iv) control of airside operations including vehicles, drivers and other personnel;
  - (v) withdrawal of non-essential vehicles and personnel;
  - (vi) suspension of routine maintenance on visual and non-visual aids;
  - (vii) securing airside access and preventing inappropriate or inadvertent entry;
  - (viii) alerting scheduled air transport operators, emergency services aircraft and other affected organisations to LVP;
  - (ix) coordination of LVP activities with ATC;
  - (x) physical checking of lighting installations and warning devices;
  - (xi) protection of the relevant critical and sensitive areas for ILS and other precision approach aids;
  - (xii) emergencies;
  - (xiii) establishing and promulgating a single point from which definitive information about the current status of LVP can be confirmed.

### 23.03 Implementation of low-visibility procedures

- (1) When meteorological conditions are such that all or part of the manoeuvring area cannot be visually monitored from the ATC tower, the aerodrome operator must coordinate with ATC to initiate the aerodrome's LVP.
- (2) At a controlled aerodrome, the aerodrome operator must cooperate with ATC to ensure that LVP are fully implemented before:
  - (a) for approach operations — the earlier of the following:
    - (i) the reported cloud ceiling falls below the precision approach CAT I decision height published in the AIP for the runway to be used;
    - (ii) the visibility falls below the precision approach CAT I RVR minimum published in the AIP for the runway to be used; and
  - (b) for take-off operations — the reported runway visibility falls below 800m, or RVR on the relevant runway falls below 550 m.

#### Notes

1. The point at which restrictions on aerodrome operations should be progressively introduced as the weather deteriorates will vary from aerodrome to aerodrome depending on local conditions. The point should relate to a specific RVR or runway visibility measurement in a worsening weather situation and should be based on the rate of weather deterioration and the amount of lead time necessary to implement extra measures.
  2. In order to continue unrestricted operations for as long as possible while weather conditions deteriorate, LVP should be designed to implement most of the ground-based measures in good time, and in certain circumstances before they are absolutely necessary. The final measures should be implemented only when the weather conditions demand it. However, there is potential for misunderstandings to occur as to the status of LVP at the aerodrome. Procedures should ensure that the potential for such misunderstandings is minimised and that there is a single point from which definitive information about the current status of LVPs can be confirmed.
  3. ATC will inform pilots that LVP are in force, but only after:
    - (a) ATC has verified that all LVP measures at the aerodrome are in place; and
    - (b) for an aerodrome conducting instrument approach operations with minima less than those for precision approach CAT I or with localiser-guided take-offs — procedures are in place to safeguard ILS critical and sensitive areas.
  4. ATC will normally inform the aerodrome operator when LVP measures must be implemented.
  5. LVP are specific to each aerodrome and may apply to a segment or the entire manoeuvring area as agreed to by the air traffic management service provider.
- (3) The aerodrome operator must advise ATC when all aerodrome operator preparations for initiation of LVP are complete.
  - (4) At a non-controlled aerodrome, LVP must be fully implemented before a pilot performs a low-visibility departure with a runway visibility below 800 m.
  - (5) For subsection (4), the aerodrome operator must advise the pilot when all aerodrome operator preparations for the initiation of the LVP that are required for low-visibility departures are complete.

### 23.04 Review of low-visibility procedures

An aerodrome operator must:

- (a) regularly review the aerodrome LVP to ensure their continuing relevance and effectiveness; and

- (b) for the reviews — consult and cooperate with local ATC and other persons or organisations involved in relevant LVP operations

### 23.05 Runway visual range equipment

If a runway is intended to support an operation mentioned in a paragraph of a row of column 1 of Table 23.05, then the aerodrome operator must:

- (a) ensure that the runway has electronic runway visual range (**RVR**) equipment in at least the places specified in column 2 of the table corresponding to the type of operation; and
- (b) confirm with the ATS provider that the ATC tower has suitable RVR display equipment.

**Table 23.05 Electronic runway visual range equipment**

Type of operation	Location of electronic RVR sensors
(a) Take-off operation with visibility < 150 m; or (b) Precision approach CAT III operation.	(1) Touchdown zone (TDZ) (2) Midpoint zone (MID) (3) Stop-end zone (END)
(a) Take-off operation with a $150\text{ m} \leq \text{visibility} < 350\text{ m}$ ; or (b) Precision approach CAT II operation; or (c) Special Authorisation CAT II operation	(1) TDZ (2) MID or END
(a) Precision approach CAT I operation with visibility < 800 m; or (b) Special Authorisation CAT I operation	TDZ

*Note* Section 23.05 does not prevent an aerodrome operator from installing RVR equipment to support other operations, or installing RVR sensors in locations other than those mentioned in Table 23.05.

### 23.06 Standards for runways supporting certain precision approach operations

- (1) A runway at an aerodrome must not be nominated for a Special Authorisation (**SA**) CAT I instrument approach operation unless:
  - (a) the aerodrome is a controlled aerodrome; and
  - (b) the runway meets the standards in this MOS for a precision approach runway; and
  - (c) the runway has electronic RVR equipment in the touchdown zone; and
  - (d) the runway has a declared landing distance available of at least 1 524 m.

*Notes*

- 1. A runway with an existing CAT II, CAT III or SA CAT II precision approach procedure is automatically eligible for SA CAT I instrument approach operations.

2. CASA recommends that, where possible, the runway should be equipped with an approach lighting system extending over a distance of at least 720 m from the runway threshold, which is either a precision approach CAT I lighting system or a precision approach CAT II and CAT III lighting system.
  3. The operating minima in each case are dictated by the available lighting facilities. Absence of an approach lighting system or a shorter approach lighting system will result in higher RVR minima. See the *Manual of Standards (MOS) Part 173 – Standards Applicable to the Provision of Instrument Flight Procedure Design* for specific details.
- (2) A runway at an aerodrome must not be nominated for an SA CAT II instrument approach operation unless:
- (a) the aerodrome is a controlled aerodrome; and
  - (b) the runway meets the standards in this MOS for a precision approach runway CAT II, except for the following lighting facilities:
    - (i) a precision approach CAT II and CAT III lighting system;
    - (ii) runway centreline lighting;
    - (iii) touchdown zone lighting; and
  - (c) the runway has electronic RVR equipment in the touchdown zone and at least 1 other zone of the runway; and
  - (d) the runway has a declared landing distance available of at least 1 830 m.

*Notes*

1. A runway with an existing CAT II or CAT III precision approach procedure is automatically eligible for SA CAT II instrument approach operations.
2. CASA recommends that, where possible, the runway should be equipped with an approach lighting system extending over a distance of at least 720 m from the runway threshold, which is either a precision approach CAT I lighting system or a precision approach CAT II and III lighting system.
3. The operating minima in each case are dictated by the available lighting facilities. Absence of runway centreline lighting, touchdown zone lighting or an approach lighting system will result in higher RVR minima. Also, a shorter approach lighting system may result in higher operating minima. See the *Manual of Standards (MOS) Part 173 – Standards Applicable to the Provision of Instrument Flight Procedure Design* for specific details.

### **23.07 Facilities and procedures for conducting runway visibility assessments**

For runway visibility (*RV*) assessments, the aerodrome operator must:

- (a) establish a system for using visibility markers or counting runway lights (or both) for assessing runway visibility; and
- (b) establish and mark fixed locations from which assessments are to be conducted; and

*Note* These locations should be near the threshold or midpoint of the runway, for example, the taxiway holding position for the taxiway adjoining the runway threshold, or at a point adjacent to the runway threshold, from which the distance to visibility markers is known.

- (c) if runway markers are to be used:
  - (i) locate visibility markers to be representative of the runway conditions; and
  - (ii) locate visibility markers within 10° of the runway centreline; and
  - (iii) provide visibility markers that:
    - (A) consist of dark objects of suitable dimension or lights of moderate intensity; and

- (B) meet the standards in this MOS for structural strength and frangibility; and
- (d) produce a visibility markers chart that includes:
  - (i) the visibility markers used to assess runway visibility, showing their distances in metres and bearings from the point of observation; and
  - (ii) the identification of the day and night visibility markers in their proper positions by means of the designated symbols listed on the chart; and
  - (iii) the clear identification of the point of observation; and
- (e) if assessments are made by counting runway lights — produce a conversion chart based on the actual spacing of the runway lights; and
- (f) include in the aerodrome manual:
  - (i) the specific procedures for the conduct of runway visibility assessments at the aerodrome; and
  - (ii) the names of persons authorised to conduct runway visibility assessments.

### **23.08 Appointed persons conducting runway visibility assessments**

An aerodrome operator must ensure that an appointed runway visibility assessor, both before appointment and at all times after appointment, has the following attributes and qualifications:

- (a) a distant visual acuity of 6/12 or better in each eye separately, and 6/9 or better binocular (with or without correcting lenses);
- (b) a certificate of proficiency in aeronautical radio telephony;
- (c) the competence to operate on the manoeuvring area of the aerodrome;
- (d) demonstrated competence in the following:
  - (i) identifying the location of each point of observation;
  - (ii) identifying the visibility markers for each point of observation;
  - (iii) identifying the relevant runway edge lights for making a runway visibility assessment;
  - (iv) using the conversion table and the visibility markers chart;
  - (v) reporting a runway visibility assessment.

### **23.09 Conducting runway visibility assessments**

- (1) Runway visibility assessments must be conducted without using any optical devices to enhance normal distance vision.

*Note* The term “optical devices” does not include spectacles or contact lenses that the person usually wears for normal distance vision.

- (2) The appointed RV assessor conducting the runway visibility assessment must:
  - (a) not, at any time, make the observations through a window, unless it is otherwise impossible to make the observations; and
  - (b) make the assessment from a nominated observation point; and

- (c) carry out the observation by:
    - (i) establishing the farthest visible runway edge lights or visibility markers that can be seen and identified; and
    - (ii) determining the distance, in metres to the nearest 50 m increment, using the conversion table or the visibility markers chart; and
    - (iii) immediately reporting to the ATS facility that serves the aerodrome, if available, or to the person who requested the report, the runway visibility along the specified runway using the following format:  
 RUNWAY VISIBILITY, RUNWAY [runway number], THRESHOLD [distance assessed in metres] {if applicable: MIDPOINT [distance assessed in metres]}, ASSESSED AT [time] UTC; and
    - (iv) if the runway visibility varies during the assessment, report the lowest value observed; and
  - (d) not report any weather phenomena that are reducing the runway visibility (other than a runway visibility assessment in accordance with section 23.07) unless the assessor is:
    - (i) authorised as a meteorological observer by, or on behalf of, the person who occupies, or for the time being holds, the position of Director of Meteorology under the *Meteorology Act 1995*; or
    - (ii) approved for the purpose by CASA, in writing; and
  - (e) limit reports to the following range of values:
    - (i) lower limit — 350 m;
    - (ii) upper limit — 1 500 m; and
  - (f) if the runway visibility is below 350 m — report the runway visibility as “less than 350 m”.
- (3) An RV assessment may only be provided to a pilot if the assessment was conducted within the previous 20 minutes.

## CHAPTER 24 AERODROME EMERGENCY PLANNING AND RESPONSE

### 24.01 Emergency committee

- (1) Subsection (2) applies to an aerodrome that, in the course of a financial year, has:
  - (a) scheduled international air transport operations; or
  - (b) 350 000 or more air transport passenger movements.
- (2) The aerodrome operator must have an aerodrome emergency committee:
  - (a) if paragraph (1) (a) applies — before scheduled international air transport operations commence; or
  - (b) if paragraph (1) (b) applies — not later than 3 months after the date of publication, by the Department, of the air transport passenger movement numbers for the aerodrome for the financial year.
- (3) The emergency committee, in conjunction with the aerodrome operator, must do the following in accordance with this Chapter:
  - (a) prepare and maintain the aerodrome emergency plan for the aerodrome;
  - (b) plan the emergency response arrangements, including emergency preparation, testing and associated exercise activities;
  - (c) ensure an appropriate and commensurate response will occur in the event of a real emergency;
  - (d) review the plan:
    - (i) following a test, an exercise or a real activation of the aerodrome emergency plan for the aerodrome; and
    - (ii) if subparagraph (i) does not apply, at least annually.

*Note* See section 11.12 for the aerodrome manual requirements.

- (4) Subject to section 24.02, if subsection (1) does not apply to an aerodrome, the aerodrome operator must:
  - (a) have appropriate emergency procedures; and
  - (b) ensure that the emergency procedures are part of the local emergency plan administered under the applicable emergency arrangements of the relevant State or Territory.

### 24.02 Aerodrome emergency plan

- (1) Subsection (2) applies to an aerodrome that, in the course of a financial year, has:
  - (a) scheduled international air transport operations; or
  - (b) 50 000 or more air transport passenger movements; or
  - (c) 100 000 or more aircraft movements.
- (2) The aerodrome operator must have an aerodrome emergency plan for the aerodrome:
  - (a) if paragraph (1) (a) applies — before scheduled international air transport operations commence; or

- (b) if paragraph (1) (b) applies — not later than 6 months after the date of publication, by the Department, of the air transport passenger movement numbers for the aerodrome for the financial year; or
  - (c) if paragraph (1) (c) applies — not later than 6 months after the date the aerodrome operator becomes aware of information indicating that, for the first time under this MOS, there have been 100 000 or more aircraft movements at the aerodrome in the course of the financial year.
- (3) The aerodrome emergency plan must describe the following:
- (a) the composition of the aerodrome emergency committee (if established);
  - (b) the procedures for liaison with emergency response authorities established under the applicable State or Territory emergency management legislation;
  - (c) notification procedures to initiate an emergency response;
  - (d) the role and function of the aerodrome operator’s personnel during an emergency;
  - (e) the aerodrome’s emergency facilities and equipment, and the procedures for keeping them in readiness for an emergency;
  - (f) the aerodrome operator’s procedures for an operational response to an emergency, including procedures for the following:
    - (i) aerodrome access;
    - (ii) escorting people off the aerodrome;
    - (iii) emergency assembly;
    - (iv) establishing an emergency command post;
    - (v) setting up aerodrome emergency facilities, including reception facilities (as applicable);
    - (vi) establishing emergency communications systems (as applicable);
    - (vii) preserving the safety of the movement area during an emergency;
    - (viii) airside emergency response by aerodrome operator’s personnel;
  - (g) for a controlled aerodrome — the procedures for a local stand-by;
  - (h) the procedures to return the aerodrome to operational status after an emergency;
  - (i) the arrangements for periodic review of the aerodrome emergency plan.
- Note* See paragraph 24.01 (3) (d) for review requirements at aerodromes with an emergency committee.
- (4) The aerodrome emergency plan must consider the following emergency scenarios:
- (a) an aircraft crash;
  - (b) a full emergency;
  - (c) a disabled aircraft;
  - (d) a health or medical emergency involving a multiple casualty incident in an aircraft, as defined in the applicable State or Territory emergency management legislation;
  - (e) events involving hazardous materials on the movement area, including any spill whose volume or mass of hazardous material is likely to cause an adverse effect on the health or safety of any person, or the safety of any aircraft;



- (f) an aircraft fire:
    - (i) within a location that would affect the safety of other aircraft, for example, aircraft docked to the terminal via an aerobridge; or
    - (ii) on the movement area;
  - (g) other emergencies likely to present a hazard to aircraft.
- (5) If an aerodrome is one:
- (a) mentioned in subsection (1); and
  - (b) whose boundary is a shoreline, or directly accesses an open body of water;
- then the aerodrome emergency plan must include arrangements for water rescue.
- Note* Water rescue may be provided by the ARFFS if present at the aerodrome. If water rescue is exclusively provided by the ARFFS, a reference to the existence of their procedures is sufficient.
- (6) Records of reviews, exercises and emergencies conducted under the aerodrome emergency plan must be:
- (a) maintained for at least 3 years after their creation; and
  - (b) made available to CASA on written request during that time.

### **24.03 Other emergency response arrangements**

- (1) An aerodrome to which section 24.02 does not apply must be clearly identified within the applicable local or state emergency response plan and emergency response arrangements.
- (2) The aerodrome must have emergency response arrangements containing:
  - (a) procedures for liaison with emergency response authorities established under the applicable State or Territory emergency management legislation; and
  - (b) notification procedures for the emergency responders; and
  - (c) aerodrome access locations and access procedures; and
  - (d) procedures for the escorting of external vehicles and personnel (if applicable); and

*Note* External vehicles may include the vehicles of other emergency services.

  - (e) procedures for the setting up of aerodrome emergency facilities including communications systems (if available); and
  - (f) airside emergency response procedures to be followed by aerodrome personnel (if applicable); and
  - (g) procedures for preservation of movement area integrity during an emergency; and
  - (h) procedures to return the aerodrome to operational status after an emergency.

### **24.04 Aerodrome location details or maps for emergency agencies**

- (1) An aerodrome operator must make available to emergency agencies location details or maps of the aerodrome and its immediate vicinity.
- (2) For subsection (1), the location details or maps must include:
  - (a) primary and secondary access points; and
  - (b) emergency assembly areas (if applicable); and

- (c) if escorts for external vehicles are not provided by the aerodrome operator — details of any aerodrome hazards that are present.

*Note* Hazard information might include, for example, drainage infrastructure, open excavations, critical or sensitive areas for navigation and communication equipment, obscured foundations or footings.

#### **24.05 Emergency preparedness — operators to whom section 24.02 applies**

- (1) An aerodrome operator to whom section 24.02 applies must test the aerodrome emergency plan:
  - (a) in the following exercises:
    - (i) a full-scale aerodrome emergency exercise conducted at intervals not exceeding 2 years;
    - (ii) in each intervening year — partial emergency exercises, for example, a tabletop exercise, to ensure that any deficiencies found during the full-scale aerodrome emergency exercise have been corrected; or
  - (b) in a series of modular tests in which:
    - (i) all modules are tested within 3 years; and
    - (ii) the interval between the test of any module and its previous test is not greater than 3 years; and
    - (iii) there is a full-scale aerodrome emergency exercise, but not sooner than 3 months before the expiry of the 3 years.
- (2) An aerodrome operator to whom section 24.02 applies must complete a review of the aerodrome emergency plan not later than 30 days after any of the following:
  - (a) the conclusion of an emergency at the aerodrome;
  - (b) an exercise conducted in accordance with subsection (1);for the purpose of correcting any deficiency found during the emergency or exercise.
- (3) The procedures under the aerodrome emergency plan mentioned in subsection (2) must be reviewed with local emergency responders at least annually.

*Note* A tabletop exercise conducted between the aerodrome operator and their local emergency responders at least once every 24 months is also recommended to formally evaluate emergency response arrangements.

- (4) Compliance with the timing requirements of subparagraphs (1) (a) (i), (1) (b) (iii), or subsection (3) may be deferred, in whole or part, for a maximum period of 24 months, with the approval in writing by CASA (subject to safety conditions, if any), if:
  - (a) the aerodrome emergency plan is activated during an actual emergency event which tested the functioning of the whole plan (the **relevant emergency**); and
  - (b) the aerodrome operator applies in writing for the deferral, and gives CASA written details of the following:
    - (i) the date, time and nature of the immediately previous emergency exercise or modular tests;
    - (ii) the date, time and nature of the relevant emergency on which the request for deferral is based;
    - (iii) all lead and support agencies that participated in the relevant emergency;

- (iv) details of how the relevant emergency tested the functioning of the plan;
- (v) details of any actions taken to correct any deficiencies found in the aerodrome emergency plan during the relevant emergency.

#### **24.06 Emergency preparedness — operators to whom section 24.02 does not apply**

- (1) An aerodrome to which section 24.02 does not apply must have procedures for emergency preparedness which ensure that local emergency responders:
  - (a) are shown the location and operation of any applicable:
    - (i) aerodrome access points; and
    - (ii) aerodrome assembly areas; and
    - (iii) aerodrome emergency facilities and equipment; and
  - (b) are made aware of any hazardous storage facilities at the aerodrome, including fuel; and
  - (c) are made aware of any aerodrome or aviation-specific emergency procedures to be followed.
- (2) The procedures under subsection (1) must be reviewed with local emergency responders at least once every 2 years.

*Note* A table-top exercise conducted between the aerodrome operator and their local emergency responders at least once every 24 months is also recommended to formally evaluate emergency response arrangements.

## CHAPTER 25 SAFETY MANAGEMENT SYSTEMS

### 25.01 Introduction

For this Chapter, a safety management system (**SMS**) is a systematic approach to managing safety at an aerodrome that must include the organisational structures, accountabilities, policies, procedures and documentation required by this Chapter to manage safety in a continuous and systematic way.

### 25.02 Requirement for an SMS

(1) For an aerodrome that, in the course of a financial year, has:

- (a) 50 000 or more air transport passenger movements; or
- (b) 100 000 or more aircraft movements;

the aerodrome operator must have an SMS.

*Note* CASA recommends that all other certified aerodromes should implement and utilise an SMS, as it provides for a systematic process to manage aerodrome safety, including hazards related to aircraft operations, through the following elements:

- (a) describing safety policies and objectives;
- (b) safety risk management processes;
- (c) safety assurance processes;
- (d) safety promotion activities.

Further guidance is available through *CASA Advisory Circular (AC) 139.C.26: Safety management systems for aerodromes*, as existing from time to time and freely available on the CASA website.

(2) The SMS (the **first SMS**) must be prepared and implemented not later than 12 months after:

- (a) for paragraph (1) (a) — the date of publication, by the Department, of the air transport passenger movement numbers indicating that, for the first time under this MOS, there have been 50 000 or more air transport passenger movements for the aerodrome for the financial year; or
- (b) for paragraph (1) (b) — the date the aerodrome operator becomes aware of information indicating that, for the first time under this MOS, there have been 100 000 or more aircraft movements at the aerodrome in the course of the financial year.

(3) The SMS must be reviewed, and revised if necessary, not later than 12 months after the first SMS, and the SMS must be reviewed, and revised if necessary, at least once every 12 months thereafter.

(4) If paragraph (2) (a) or (2) (b):

- (a) applied to an aerodrome operator; and
- (b) subsequently ceased to apply to the operator; and
- (c) subsequently would have applied to the operator again if such application were deemed to be for the first time under this MOS;

then:

- (d) the paragraph applies to the operator as if it were for the first time under this MOS (the **deemed first time**); and
- (e) subsection (3) applies to the operator for the second and subsequent reviews after the deemed first time.

- (5) The operator of an aerodrome with scheduled international air transport operations must have an SMS before such scheduled operations commence.
- (6) The aerodrome operator must ensure that the SMS is:
  - (a) maintained as a functioning system that is guided and supported by the SMS documentation required by this Chapter; and
  - (b) commensurate with the size of the aerodrome and the complexity of its activities; and
  - (c) used to ensure that aviation safety risks associated with the aerodrome's activities are reduced to a level that is as low as reasonably practicable; and
  - (d) reviewed at least once every 12 months.

### **25.03 Matters which must be addressed in an SMS**

- (1) The SMS must provide for, and include documented details of, the aerodrome operator's:
  - (a) commitment to, and responsibility for, aerodrome safety; and
  - (b) safety policy and safety objectives.
- (2) The SMS must provide for, and include documented details of, the safety accountabilities of the aerodrome operator's managers.
- (3) The SMS must provide for, and include documented details of, the aerodrome operator's procedures for the following:
  - (a) the appointment of safety management personnel;
  - (b) relevant third-party relationships and interactions;
  - (c) coordination of an emergency response plan;
  - (d) identification of, and access to, documentation relevant to the SMS.
- (4) The SMS must provide for, and include documented details of, the aerodrome operator's safety risk management processes, including:
  - (a) hazard identification processes; and
  - (b) risk assessment and mitigation processes.
- (5) The SMS must provide for, and include documented details of, the aerodrome operator's safety assurance process, including the procedures for the following:
  - (a) safety performance monitoring and measurement;
  - (b) internal safety investigation;
  - (c) management of change that may affect safety;
  - (d) continuous improvement of the SMS.
- (6) The SMS must provide for, and include documented details of, the aerodrome operator's safety training and promotion process, including the procedures for the following:
  - (a) SMS training and education;
  - (b) SMS safety communication.

## **25.04 Particular SMS matters for aerodromes with scheduled international air transport operations**

- (1) The operator of an aerodrome that has scheduled international air transport operations must have an SMS that:
  - (a) complies with section 25.03; and
  - (b) provides for, and includes documented details of, the matters mentioned in this section.

### **Management commitment**

- (2) The aerodrome operator's safety policy must:
  - (a) reflect organisational commitment to safety, including the promotion of a positive safety culture; and
  - (b) include a clear statement about the allocation of resources for the implementation of the safety policy; and
  - (c) include safety reporting procedures; and
  - (d) in the context of the aerodrome operator's aviation activities — indicate which types of behaviours are unacceptable as well as indicating circumstances under which disciplinary action would not apply; and
  - (e) be signed by the accountable manager; and
  - (f) be communicated and promoted throughout the aerodrome operator's organisation; and
  - (g) be periodically reviewed to ensure it remains relevant and appropriate to the operator.

### **Safety objectives**

- (3) The aerodrome operator's safety objectives must:
  - (a) form the basis for safety performance monitoring and measurement; and
  - (b) reflect the aerodrome operator's commitment to continuously improve the effectiveness of the SMS; and
  - (c) be communicated and promoted throughout the organisation; and
  - (d) be periodically reviewed to ensure the objectives remain relevant and appropriate to the operator.

### **Safety accountabilities and responsibilities**

- (4) The safety accountabilities must identify:
  - (a) the accountable manager who, irrespective of other functions, is accountable to the aerodrome operator for implementation and maintenance of an effective SMS; and
  - (b) the organisational lines of accountability for safety, including the direct accountability of specified senior management personnel; and
  - (c) the responsibilities of all members of the operator's organisation who, irrespective of other functions, have responsibility for safety performance; and
  - (d) the specific levels of management with authority to make decisions regarding safety risk tolerability.

## Appointment of primary person responsible for the SMS

- (5) The SMS must identify at least one senior management individual, appointed by the aerodrome operator under the SMS, to be the primary person responsible for implementation, and continuous improvement, of the SMS (the *primary person responsible for the SMS*).

*Note* Depending on the size of the aerodrome and the complexity of its operations or services, responsibility for implementation and maintenance of the SMS may be assigned to one or more persons. The role of safety manager could be a sole function, or a function combined with other duties provided the other duties did not result in a conflict of interest or adversely affect the performance of safety duties.

## Third-party interfaces

- (6) The SMS must include procedures to ensure that:
- (a) products or services provided by any third parties in the conduct of the aerodrome operator's activities do not compromise aviation safety; and
  - (b) safety-critical information derived from the SMS is actively conveyed to relevant third parties.

## Coordination of emergency response planning

- (7) The SMS must include:
- (a) an emergency response plan that addresses accidents and incidents in aircraft operations and other aviation emergencies; and
  - (b) procedures to ensure that the emergency response plan is properly coordinated with the emergency response plans of those organisations with which it must interface during the operator's provision of aviation activities, products and services.

## SMS documentation

- (8) The SMS must provide for the following:
- (a) an up-to-date SMS manual that describes the following:
    - (i) the safety policy and objectives;
    - (ii) the SMS requirements;
    - (iii) the SMS processes and procedures;
    - (iv) the accountabilities, responsibilities and authorities for SMS processes and procedures;
    - (v) the minimum skills and knowledge required for the primary person responsible for the SMS;

*Note* Depending on the size of the aerodrome and the complexity of its aviation products or services, the SMS manual may be a stand-alone document or may be integrated with other organisational documents.

- (b) the creation, maintenance and retention of relevant operational records arising from the implementation and operation of the SMS under this Chapter.

*Note 1* Relevant SMS operational records would include records, reviews, reports, assessments, analyses, verifications, investigations, training and communication programs, risk and hazard registers, safety cases, and details of persons who are or have been the primary persons responsible for the SMS.

*Note 2* Depending on the size of the aerodrome and the complexity of its aviation products or services, SMS operational records may be a stand-alone collection or database, or they may be integrated with other organisational documents.

### Hazard identification

- (9) The SMS must include the aerodrome operator's procedures to:
- (a) identify hazards associated with its aviation activities, aviation products or aviation services; and
  - (b) ensure that hazard identification is based on a combination of proactive and reactive methods of safety data collection.

### Safety risk assessment and control

- (10) The SMS must include the aerodrome operator's procedures to ensure the analysis, assessment and control of the safety risks associated with identified hazards.

### Safety performance monitoring and measurement

- (11) The SMS must include the aerodrome operator's procedures to:
- (a) verify the operator's own safety performance and validate the effectiveness of risk controls; and
  - (b) ensure that the operator's safety performance is verified by reference to:
    - (i) specified safety performance indicators; and
    - (ii) the safety performance targets of the SMS; and
    - (iii) the SMS's safety objectives.

### Internal safety investigation

- (12) The SMS must include the aerodrome operator's procedures for internal safety investigations, including procedures to:
- (a) determine the level of investigation required for particular types of adverse events; and
  - (b) endeavour to establish the root cause of adverse events that are investigated; and
  - (c) communicate throughout the organisation the outcome of investigations.

### Management of change

- (13) The SMS must include the aerodrome operator's procedures to:
- (a) identify changes which could affect the level of safety risk associated with the operator's aviation products or services; and
  - (b) identify and manage the safety risks that could arise from those changes.

### Continuous improvement of the SMS

- (14) The SMS must include the aerodrome operator's procedures to ensure the maintenance of, and continuous improvement in, the overall effectiveness of the SMS.

### SMS training and education

- (15) The SMS must include the aerodrome operator's procedures to maintain and deliver a safety training program to ensure that:
- (a) the operator's personnel are trained and competent to perform their SMS duties; and



- (b) as far as possible, and to the degree appropriate, the relevant personnel of third-party service providers are provided with relevant SMS training; and

*Note* CASA considers “relevant personnel” to be persons whose role as a third party in relation to an aerodrome could affect aviation safety at the aerodrome.

- (c) the scope of the SMS training is appropriate to each individual’s involvement in the SMS.

#### Safety communication

- (16) The SMS must include the aerodrome operator’s procedures to maintain a formal means of safety communication that:
  - (a) ensures personnel are aware of the SMS to a degree commensurate with their positions; and
  - (b) conveys safety-critical information; and
  - (c) communicates safety accountabilities, responsibilities and authorities throughout the operator’s organisation; and
  - (d) explains why particular actions are taken to improve safety; and
  - (e) explains why safety procedures are introduced or changed.

## CHAPTER 26 RISK MANAGEMENT PLANS

### 26.01 Introduction

- (1) Except when an SMS is provided in accordance with Chapter 25, for an aerodrome that, in the course of a financial year, has either of the following:
  - (a) 25 000 or more air transport passenger movements;
  - (b) 20 000 or more aircraft movements;

the aerodrome operator must have a risk management plan (RMP) prepared and implemented by not later than 12 months after:

- (c) for paragraph (a) — the date of publication, by the Department, of the air transport passenger movement numbers indicating that there have been 25 000 or more air transport passenger movements for the aerodrome for the financial year; or
- (d) for paragraph (b) — the date the aerodrome operator becomes aware of information indicating that there have been 20 000 or more aircraft movements at the aerodrome in the course of the financial year.

*Note* CASA recommends that all other aerodromes should implement and utilise an SMS, as it provides for a systematic process to manage hazards related to aircraft operations through the following elements:

- (a) describing safety policies and objectives;
- (b) safety risk management processes;
- (c) safety assurance processes;
- (d) safety promotion activities.

Further guidance is available through *CASA Advisory Circular (AC) 139.C.27: Risk management plans for aerodromes*, as existing from time to time and freely available on the CASA website.

- (2) Any procedure, system or manual used by an aerodrome operator to manage hazards affecting aircraft operations is deemed to be a risk management plan and must comply with this section.
- (3) The aerodrome operator must ensure that a risk management plan is:
  - (a) maintained as a functioning plan; and
  - (b) commensurate with the size of the aerodrome and the complexity of its activities; and
  - (c) used to ensure that aviation safety risks associated with the aerodrome's activities are reduced to a level that is as low as reasonably practicable; and
  - (d) reviewed at least once every 12 months.
- (4) A risk management plan must address the following:
  - (a) hazard identification;
  - (b) risk assessment and control;
  - (c) creation and management of relevant risk management plan documents, including:
    - (i) a risk register; and
    - (ii) records of any dedicated risk assessments performed to address aerodrome hazards affecting aircraft operations.
- (5) If paragraph (1) (a) or (1) (b):
  - (a) applied to an aerodrome operator; and

- (b) subsequently ceased to apply to the operator; and
- (c) subsequently would have applied to the operator again if such application were deemed to be for the first time under this MOS;

then:

- (d) the paragraph applies to the operator as if it were for the first time under this MOS (the *deemed first time*); and
- (e) paragraph (3) (d) applies to the operator for the second and subsequent reviews after the deemed first time.

# NOTES TO PART 139 (AERODROMES) MANUAL OF STANDARDS 2019

## Note 1

The *Part 139 (Aerodromes) Manual of Standards 2019 (MOS)* (in force under the *Civil Aviation Safety Regulations 1998*) as shown in this compilation comprises Part 139 (Aerodromes) Manual of Standards 2019 amended as indicated in the Tables below.

### Table of Manual of Standards and Amendments

Year and number	Date of registration on FRL	Date of commencement	Application, saving or transitional provisions
<i>Part 139 (Aerodromes) Manual of Standards 2019</i>	6 September 2019 (see F2019L01146)	13 August 2020 (see s. 1.02 and F2020L00913)	—
<i>Part 139 (Aerodromes) Manual of Standards Amendment Instrument 2020 (No. 1)</i>	22 July 2020 (see F2020L00931)	13 August 2020 (see s. 2)	—
<i>Part 139 Manual of Standards (Global Reporting Format and Miscellaneous Amendments) Instrument (No. 1) 2024</i>	9 February 2024 (see F2024L00152)	10 February 2024 (see s. 2)	—

### Table of Amendments

ad. = added or inserted   am. = amended   rep. = repealed   rs. = repealed and substituted

Provision affected	How affected
Chapter 1A	ad. F2020L00931
para. 2.04 (3) (a)	am. F2020L00931
subs. 2.04 (3A) and (3B)	ad. F2020L00931
s. 2.04A	ad. F2020L00931
subs. 3.01 (2)	am. F2024L00152
subs. 5.12 (6), the Note only	rs. F2020L00931
subs. 5.12 (13), the Note only	am. F2024L00152
subs. 5.12 (14), the Note only	am. F2024L00152
subs. 6.04 (2)	am. F2020L00931
subs. 6.08 (2)	am. F2020L00931
subs. 6.09 (2), the Note only	am. F2024L00152
subs. 6.39 (1), the Note only	am. F2024L00152
subs. 6.41 (2)	am. F2020L00931
s. 6.53, Table 6.53 (1)-1	am. F2020L00931
Table 6.53 (1)-2, the Note only	am. F2024L00152
Figure 58 (2)-1	rs. F2020L00931

Notes

## Table of Amendments

ad. = added or inserted am. = amended rep. = repealed rs. = repealed and substituted

Provision affected	How affected
subs. 6.59 (1), the Note only	am. F2024L00152
Table 7.15 (1), the Note only	am. F2024L00152
subs. 7.21 (9), the Note only	am. F2024L00152
subs. 7.22 (3), the Note only	am. F2024L00152
subs. 7.23 (1), the Note only	am. F2024L00152
subs. 7.24 (3), the Note only	am. F2024L00152
subs. 8.49 (2), the Note only	am. F2024L00152
para. 8.16 (2) (e)	am. F2024L00152
subs. 8.85 (6), the Note only	am. F2024L00152
subs. 8.85 (10), the Note only	am. F2024L00152
subs. 8.112 (1), the Note only	am. F2024L00152
s. 8.116, the Note only	am. F2024L00152
s. 8.118, the Note only	am. F2024L00152
subs. 9.02 (2), the Note only	am. F2024L00152
subs. 9.09 (1), the Note only	am. F2024L00152
para. 9.18 (1) (c)	rs. F2024L00152
subs. 9.18 (2)	rs. F2024L00152
s. 9.20, the Note	am. F2020L00931
subpara. 9.36 (3) (c) (ii)	am. F2020L00931
subs. 9.39 (7), the Note only	am. F2024L00152
subs. 9.4 1 (4), the Note only	am. F2024L00152
subs. 9.41 (13), the Note only	am. F2024L00152
subs. 9.42 (20), the Note only	am. F2024L00152
subs. 9.44 (5)	am. F2020L00931
subs. 9.105 (3)	am. F2020L00931
para. 9.105 (4) (a)	am. F2020L00931
subs. 9.105 (4), Note 2	am. F2020L00931
subs. 9.108 (1)	am. F2020L00931
subs. 9.41 (4), the Note only	am. F2024L00152
subs. 9.41 (13), the Note only	am. F2024L00152
subs. 9.42 (20), the Note only	am. F2020L00931
para. 11.03 (1) (b)	rs. F2024L00152
para. 11.05 (1) (d)	rs. F2024L00152
para. 11.07 (1) (f)	rs. F2024L00152
s. 11.14	rs. F2024L00152
para. 12.01 (1) (a)	rs. F2024L00152
para. 12.01 (1) (d), including the Note	rs. F2024L00152
subs. 12.01 (2)	rs. F2024L00152

Notes

## Table of Amendments

ad. = added or inserted   am. = amended   rep. = repealed   rs. = repealed and substituted

Provision affected	How affected
subs. 12.01 (2A)	ad. F2024L00152
subs. 12.03 (3), the heading	rs. F2024L00152
subs. 12.04, the heading	rs. F2024L00152
subs. 12.04A	ad. F2024L00152
para. 13.03 (c)	am. F2024L00152
subs. 13.03 (d)	am. F2024L00152
subs. 14.03 (4)	rs. F2024L00152
subs. 14.03 (8)	rs. F2024L00152
s. 14.06	ad. F2024L00152
subs.18.02 (2), Note (2)	rs. F2024L00152
subs. 18.02 (2A)	ad. F2024L00152
s. 18.03	ad. F2024L00152
subs. 22.01 (5), the Note only	am. F2024L00152